



thermo scientific

# **TSQ 9610**

## **Mass Spectrometers**

### **User Guide**

1R120622-0002 Revision B July 2024

**ThermoFisher**  
SCIENTIFIC

© 2024 Thermo Fisher Scientific Inc. All rights reserved.

TSQ, TRACE, TriPlus, and Chromeleon are trademarks, and Xcalibur is a registered trademark of Thermo Fisher Scientific in the United States.

The following are registered trademarks in the United States and other countries: Microsoft, and Windows are registered trademarks of Microsoft. Adobe and Acrobat are registered trademarks of Adobe Systems Incorporated. SilTite is a registered trademark of SGE Analytical Science in the United States. McAfee is a registered trademark of McAfee, Inc. in the United States and other countries. Vespel is a registered trademark of E.I. du Pont de Nemours and Company in the United States and other countries.

Thermo Fisher Scientific Inc. provides this document to its customers with a product purchase to use in the product operation. This document is copyright protected and any reproduction of the whole or any part of this document is strictly prohibited, except with the written authorization of Thermo Fisher Scientific Inc.

The contents of this document are subject to change without notice. All technical information in this document is for reference purposes only. System configurations and specifications in this document supersede all previous information received by the purchaser.

This document is not part of any sales contract between Thermo Fisher Scientific Inc. and a purchaser. This document shall in no way govern or modify any Terms and Conditions of Sale, which Terms and Conditions of Sale shall govern all conflicting information between the two documents.

Release history: Revision A, April 2022; Revision B, July 2024.

Software version: TSQ Series 5.0 or later.

**General Lab Equipment, Not for Clinical, Patient or Diagnostic Use.**

# Contents

<b>Preface</b> .....	<b>xiii</b>
About Your System .....	xiv
Related Documentation .....	xiv
System Requirements .....	xvi
Safety and Special Notices .....	xvi
Special Notices .....	xvi
Safety Symbols and Signal Words .....	xvii
Hydrogen Safety Precautions .....	xx
Using Hydrogen with a GC-MS/MS System .....	xxi
Hydrogen Connection Guidelines .....	xxii
Purchasing Hydrogen .....	xxiii
Properly Storing Hydrogen .....	xxiv
Hydrogen Safety Codes, Standards and References .....	xxvi
Hazardous Substances Precautions .....	xxvii
Biological Hazard Warning Note .....	xxviii
Venting Toxic Gases .....	xxix
Contacting Us .....	xxix
<b>Chapter 1 Introduction</b> .....	<b>1</b>
Confirming Your Instrument is Working .....	1
Checking Power to the System .....	1
Verifying the Carrier Gas Flow Rate .....	2
Checking Your Carrier Gas Supply Pressure .....	3
Verify Collision Gas Supply Pressure .....	3
Checking the Vacuum and Temperature .....	4
Cleaning the Exterior of Your Instrument .....	6
Configuring Your Instrument .....	6
<b>Chapter 2 Changing the Column</b> .....	<b>21</b>
Determining the Column Type .....	21

	Replacing the Factory Installed Column . . . . .	23
	Replacing a column in a TSQ 9610 system with no VPI or an Standard AEI ion source. . . . .	23
	Replacing a column on a TSQ 9610 system with a VPI and an ExtractaBrite ion source or a NeverVent AEI (NVAEI) ion source. . . . .	33
	Installing the Column in the GC Inlet . . . . .	39
<b>Chapter 3</b>	<b>Tuning . . . . .</b>	<b>45</b>
	Accessing AutoTune . . . . .	46
	Tune Types . . . . .	49
	EI Initial Tune . . . . .	50
	EI Full Tune . . . . .	50
	EI Tune. . . . .	52
	EI Check. . . . .	52
	EI Diagnostics . . . . .	52
	Negative CI Tune . . . . .	53
	Positive CI Tune . . . . .	54
	AEI Full Tune . . . . .	56
	AEI Tune . . . . .	56
	AEI Check. . . . .	57
	AEI Diagnostics. . . . .	57
	Tuning the Mass Spectrometer . . . . .	57
<b>Chapter 4</b>	<b>Creating a Method. . . . .</b>	<b>69</b>
	Accessing the Method Editor. . . . .	69
	Creating a GC-MS Method in Xcalibur Software . . . . .	72
	Creating an Autosampler Method in Xcalibur Software. . . . .	73
	Creating a MS Instrument Method in Xcalibur Software. . . . .	76
	Creating a GC Method in Xcalibur Software. . . . .	104
	Creating a GC-MS Method in Chromeleon Software . . . . .	110
	Validating and Troubleshooting Methods . . . . .	141
<b>Chapter 5</b>	<b>Optimizing Your Method . . . . .</b>	<b>145</b>
	Changing the Chromatographic Separation. . . . .	145
	Finding the Best Way to Make an Injection . . . . .	146
	Improving the Way You Prepare Samples . . . . .	146
	Changing the Dwell Time or Scan Rate . . . . .	146
	Narrowing the Mass Range . . . . .	147
	Adjusting the Transfer Line and Ion Source Temperature. . . . .	147
	Optimizing an SRM Method . . . . .	148
	Optimizing an NCI Tune . . . . .	148
	Modifying an Automatic Tune . . . . .	153
<b>Chapter 6</b>	<b>Using AutoSRM . . . . .</b>	<b>189</b>
	Determining Precursor Ions . . . . .	189

	Conducting the Product Ion Study . . . . .	199
	Developing the SRM Optimization Study . . . . .	204
	Importing Transitions to the Method Editor . . . . .	208
<b>Chapter 7</b>	<b>Computer Settings . . . . .</b>	<b>213</b>
	System Requirements . . . . .	213
	Computer Settings . . . . .	213
	Excluding the Xcalibur Directory from Virus Scan . . . . .	216
<b>Chapter 8</b>	<b>Troubleshooting . . . . .</b>	<b>217</b>
	Setting Instrument Conditions for Troubleshooting . . . . .	218
	Checking Air/Water Spectra . . . . .	219
	Diagnostics Checks . . . . .	225
	Resetting Chromeleon after Replacing a Blown Filament . . . . .	225
	How to Know When Your System Needs Maintenance . . . . .	226
	Investigating Baseline Issues . . . . .	231
	Investigating Peak Issues . . . . .	233
	Investigating Results Issues . . . . .	236
	<b>Index . . . . .</b>	<b>239</b>



## Declaration

Manufacturer: Thermo Fisher Scientific

Thermo Fisher Scientific is the manufacturer of the instrument described in this manual and, as such, is responsible for the instrument safety, reliability and performance only if:

- installation,
- recalibration, and
- changes and repairs

have been carried out by authorized personnel and if:

- the local installation complies with local law regulations,
- the instrument is used according to the instructions provided, and
- if its operation is only entrusted to qualified trained personnel.

Thermo Fisher Scientific is not liable for any damages derived from the non-compliance with the aforementioned recommendations.

## Regulatory Compliance

Thermo Fisher Scientific performs complete testing and evaluation of its products to ensure full compliance with applicable domestic and international regulations. When the system is delivered to you, it meets all pertinent electromagnetic compatibility (EMC) and safety standards as described in the next section or sections by product name.

Changes that you make to your system may void compliance with one or more of these EMC and safety standards. Changes to your system include replacing a part or adding components, options, or peripherals not specifically authorized and qualified by Thermo Fisher Scientific. To ensure continued compliance with EMC and safety standards, replacement parts and additional components, options, and peripherals must be ordered from Thermo Fisher Scientific or one of its authorized representatives.

## EMC Directive 89/336/EEC

EMC compliance has been evaluated by Professional Testing.

- Direct Probe Controller (DPC) standards: EMC EN 61326-1:2006. Safety IEC 61010-1:2001, IEC 61010-2-081:2001
- ISQ, ISQ 7000, and ISQ 7610 standards: EMC EN 61326-1:2013. Safety IEC 61010-1:2010, IEC 61010-2-010:2014, IEC 61010-2-081:2015.
- TSQ 8000, TSQ 8000 Evo, TSQ Duo, TSQ 9000, and TSQ 9610 standards: EMC EN 61326-1:2013. Safety IEC 61010-1:2010, IEC 61010-2-010:2014, IEC 61010-2-081:2015.

## Low Voltage Safety Compliance

This device complies with Low Voltage Directive 2006/95/EC and harmonized standard EN 61010-1:2001.

## FCC Compliance Statement

THIS DEVICE COMPLIES WITH PART 15 OF THE FCC RULES. OPERATION IS SUBJECT TO THE FOLLOWING TWO CONDITIONS: (1) THIS DEVICE MAY NOT CAUSE HARMFUL INTERFERENCE, AND (2) THIS DEVICE MUST ACCEPT ANY INTERFERENCE RECEIVED, INCLUDING INTERFERENCE THAT MAY CAUSE UNDESIRE OPERATION.



**CAUTION** Read and understand the various precautionary notes, signs and symbols contained inside this manual pertaining to the safe use and operation of this product before using it.

## Notice on Lifting and Handling of Thermo Scientific Instruments

For your safety, and in compliance with international regulations, the physical handling of this Thermo Fisher Scientific instrument *requires a team effort* to lift and/or move the instrument. This instrument is too heavy and/or bulky for one person alone to handle safely.

## Notice on the Proper Use of Thermo Scientific Instruments


In compliance with international regulations: Use of this instrument in a manner not specified by Thermo Fisher Scientific could impair any protection provided by the instrument.



# Declarations of Conformity

-Original-

**EU Declaration of Conformity**  
*EU-Konformitätserklärung*



**ThermoFisher**  
SCIENTIFIC

Thermo Fisher Scientific  
2215 Grand Avenue Parkway  
Austin, Texas 78728  
USA

We hereby declare that the following products

**Designation:** Mass Spectrometer

**Model:** Thermo Scientific ISQ Series  
*ISQ7K Series, ISQ 7610 Series*

fulfill all the relevant requirements of the following directives:


Low Voltage Directive	2014/35/EU
Electromagnetic Compatibility Directive	2014/30/EU
RoHS Directive	2011/65/EU and (EU) 2015/863

The following relevant harmonized standards were used:

EN 61010-1:2020-03	EN 61326-1:2013-07
--------------------	--------------------

Person authorized to compile the technical file:


Brody Guckenberger  
(Director, Applied Research)  
Thermo Fisher Scientific

  
 Signature

Austin, March 4, 2022  
 Date

-Original-

**UK Declaration of Conformity**



**ThermoFisher**  
SCIENTIFIC

Thermo Fisher Scientific  
2215 Grand Avenue Parkway  
Austin, Texas 78728  
USA

Declares, under sole responsibility, that products

**Designation:** Mass Spectrometer

**Model:** Thermo Scientific ISQ Series  
*ISQ7K Series, ISQ 7610 Series*

as originally delivered complies with the essential requirements of the following applicable UK Regulations:


Electrical Equipment (Safety) Regulations	2016
Electromagnetic Compatibility Regulations	2016
The Restriction of the Use of Certain Hazardous Substances in Electrical and Electronic Equipment (ROHS) Regulations	2012

and complies with the following harmonized standards and other technical specifications:

BS EN 61010-1:2010+A1:2019	BS EN 61326-1:2021
----------------------------	--------------------

Signed for and on behalf of: Thermo Fisher Scientific:

Brody Guckenberger  
(Director, Applied Research)  
Thermo Fisher Scientific

  
 Signature

Austin, March 4, 2022  
 Date

## Notice on the Susceptibility to Electromagnetic Transmissions

Your instrument is designed to work in a controlled electromagnetic environment. Do not use radio frequency transmitters, such as mobile phones, in close proximity to the instrument.

For manufacturing location, see the label on the instrument.

## WEEE Compliance

This product is required to comply with the European Union's Waste Electrical & Electronic Equipment (WEEE) Directive 2002/96/EC. It is marked with the following symbol:



Thermo Fisher Scientific has contracted with one or more recycling or disposal companies in each European Union (EU) Member State, and these companies should dispose of or recycle this product. See [www.thermoscientific.com/rohswcee](http://www.thermoscientific.com/rohswcee) for further information on Thermo Fisher Scientific's compliance with these Directives and the recyclers in your country.

## WEEE Konformität

Dieses Produkt muss die EU Waste Electrical & Electronic Equipment (WEEE) Richtlinie 2002/96/EC erfüllen. Das Produkt ist durch folgendes Symbol gekennzeichnet:



Thermo Fisher Scientific hat Vereinbarungen mit Verwertungs-/Entsorgungsfirmen in allen EU-Mitgliedsstaaten getroffen, damit dieses Produkt durch diese Firmen wiederverwertet oder entsorgt werden kann. Mehr Information über die Einhaltung dieser Anweisungen durch Thermo Fisher Scientific, über die Verwerter, und weitere Hinweise, die nützlich sind, um die Produkte zu identifizieren, die unter diese RoHS Anweisung fallen, finden sie unter [www.thermoscientific.com/rohswcee](http://www.thermoscientific.com/rohswcee).

## Conformité DEEE

Ce produit doit être conforme à la directive européenne (2002/96/EC) des Déchets d'Équipements Électriques et Electroniques (DEEE). Il est marqué par le symbole suivant:



Thermo Fisher Scientific s'est associé avec une ou plusieurs compagnies de recyclage dans chaque état membre de l'union européenne et ce produit devrait être collecté ou recyclé par celles-ci. Davantage d'informations sur la conformité de Thermo Fisher Scientific à ces directives, les recycleurs dans votre pays et les informations sur les produits Thermo Fisher Scientific qui peuvent aider la détection des substances sujettes à la directive RoHS sont disponibles sur [www.thermoscientific.com/rohsweee](http://www.thermoscientific.com/rohsweee).



## Preface

This guide contains detailed information about how to use your Thermo Scientific™ TSQ™ 9610 triple-quadrupole GC/MS system. The TSQ 9610 system provides the selectivity and sensitivity of a triple-quadrupole GC/MS while also functioning as a high-performance single quadrupole instrument. The system is designed to stay cleaner longer to maximize your instrument's uptime and improve your lab's productivity. The need to break vacuum, cool off your system, and spend hours cleaning, reassembling, and restoring the system is greatly reduced if you have an ExtractaBrite ion source and a NeverVent-enabled system. The extractable source incorporates a cartridge that contains the repeller, source lenses, and RF lens, all of which can be removed from the instrument without breaking vacuum. What once took hours, or even an entire day, is now accomplished in minutes. An AEI ion source, which provides unmatched sensitivity, is also available on the system.

In addition, the TSQ 9610 system includes innovative Thermo Scientific software that will help users new to triple-quadrupole GC/MS/MS systems develop selected reaction monitoring (SRM) methods.

### Contents

- [About Your System](#)
- [Related Documentation](#)
- [System Requirements](#)
- [Safety and Special Notices](#)
- [Hydrogen Safety Precautions](#)
- [Hazardous Substances Precautions](#)
- [Contacting Us](#)

## About Your System

GC/MS represents a combination of two powerful analytical techniques: GC, which acts as a separation technique, and MS, which acts as a detection technique. Complex mixtures of individual compounds can be injected into the GC, either manually or by an autosampler and then separated for presentation to the MS. The MS will generate a mass spectrum of the GC eluate and its components. The mass spectrum can then be used for qualitative identification as well as accurate and precise quantification of the individual compounds present in the sample.

A triple-quadrupole GC/MS/MS system provides the extra selectivity required for trace analysis of compounds in complex matrices.



**WARNING** Thermo Scientific systems operate safely and reliably under carefully controlled environmental conditions. If the equipment is used in a manner not specified by the manufacturer, the protections provided by the equipment might be impaired. If you maintain a system outside the specifications listed in this guide, failures of many types, including personal injury or death, might occur. The repair of instrument failures caused by operation in a manner not specified by the manufacturer is specifically excluded from the standard warranty and service contract coverage.



**AVERTISSEMENT** Les systèmes Thermo Fisher Scientific fonctionnent de manière sûre et fiable dans des conditions ambiantes minutieusement régulées. La protection fournie par l'équipement peut être entravée si ce dernier est utilisé d'une manière non spécifiée par le fabricant. Si vous maintenez un système en dehors des spécifications listées dans ce guide, des défaillances de types divers sont possibles, pouvant notamment entraîner des blessures, voire la mort. La réparation des défaillances d'instruments liées à une utilisation non conforme aux spécifications du fabricant est expressément exclue de la garantie standard et de la couverture prévue par un contrat de maintenance.

## Related Documentation

The TSQ 9610 system includes Help and these manuals as PDF files:

- *TSQ 9610 Preinstallation Guide*, PN 1R120622-0001
- *TSQ 9610 User Guide*, PN 1R120622-0002
- *TSQ 9610 Hardware Manual*, PN 1R120622-0003
- *ISQ and TSQ GC-MS Spare Parts Guide*, PN 1R120621-0004
- *Direct Probe System User Guide*, PN 1R120505-0006

❖ **To view product manuals**

Open the desktop folder **Manuals**.

❖ **To open Help**

- In Xcalibur software, From the TSQ Series window in the Method Editor, choose **Help > TSQ Series Help**.
- In Chromeleon software, TSQ Series Help can be accessed through the Method Editor.
- If available for a specific window or dialog box, click **Help** or press the F1 key for information about setting parameters.

For more information, visit [www.thermofisher.com](http://www.thermofisher.com).

## System Requirements

Your TSQ 9000 data system must meet these minimum requirements.

System	Requirements
Hardware	<ul style="list-style-type: none"><li>• 3.6 GHz dual-core processor enabled</li><li>• 16 GB RAM with system managed memory enabled</li><li>• DVD drive</li><li>• Resolution display 1280 × 1024 (SXGA)</li><li>• 20 GB available on drive C</li><li>• NTFS format</li></ul>
Software	<ul style="list-style-type: none"><li>• Microsoft™ Windows™ 10 Operating System (64-bit) English only or Windows 7 Professional Operating System (64-bit)</li><li>• Microsoft .NET Framework 4.0 or later</li><li>• Thermo Scientific™ Xcalibur™ and Foundation software<sup>a</sup></li><li>• Thermo Scientific™ TraceFinder™ software<sup>b</sup></li><li>• Thermo Scientific™ Dionex™ Chromeleon software<sup>b</sup></li></ul>

<sup>a</sup> Check release notes for compatibility with TSQ Series instrument control software.

<sup>b</sup> Check release notes for compatibility with Thermo Foundation, Xcalibur, and TSQ Series instrument control software.

## Safety and Special Notices

Make sure you follow the precautionary statements presented in this guide. The safety and other special notices appear in boxes.

### Special Notices

Special notices include the following:

**IMPORTANT** Highlights information necessary to prevent damage to software, loss of data, or invalid test results; or might contain information that is critical for optimal performance of the system.










**Note** Highlights information of general interest.






**Tip** Highlights helpful information that can make a task easier.






## Safety Symbols and Signal Words

All safety symbols are followed by **WARNING** or **CAUTION**, which indicates the degree of risk for personal injury, instrument damage, or both. Cautions and warnings are following by a descriptor. A **WARNING** is intended to prevent improper actions that *could* cause personal injury. A **CAUTION** is intended to prevent improper actions that *might* cause personal injury or instrument damage. You can find the following safety symbols on your instrument or in this guide.



Symbol	Descriptor
	<b>BIOHAZARD:</b> Indicates that a biohazard <i>will, could, or might</i> occur.
	<b>BURN HAZARD:</b> Alerts you to the presence of a hot surface that <i>could</i> or <i>might</i> cause burn injuries.
	<b>ELECTRICAL SHOCK HAZARD:</b> Indicates that an electrical shock <i>could</i> or <i>might</i> occur.
	<b>FIRE HAZARD:</b> Indicates a risk of fire or flammability <i>could</i> or <i>might</i> occur.
	<b>FLAMMABLE GAS HAZARD:</b> Alerts you to gases that are compressed, liquefied or dissolved under pressure and can ignite on contact with an ignition source. This symbol indicates this risk <i>could</i> or <i>might</i> cause physical injury.
	<b>GLOVES REQUIRED:</b> Indicates that you must wear gloves when performing a task or physical injury <i>could</i> or <i>might</i> occur.
	<b>HAND AND CHEMICAL HAZARD:</b> Indicates that chemical damage or physical injury <i>could</i> or <i>might</i> occur.
	<b>INSTRUMENT DAMAGE:</b> Indicates that damage to the instrument or component <i>might</i> occur. This damage might not be covered under the standard warranty.
	<b>LIFTING HAZARD:</b> Indicates that a physical injury <i>could</i> or <i>might</i> occur if two or more people do not lift an object.

Symbol	Descriptor
	<b>MATERIAL AND EYE HAZARD:</b> Indicates that eye damage <i>could</i> or <i>might</i> occur.
	<b>RADIOACTIVE HAZARD:</b> Indicates that exposure to radioactive material <i>could</i> or <i>might</i> occur.
	<b>READ MANUAL:</b> Alerts you to carefully read your instrument's documentation to ensure your safety and the instrument's operational ability. Failing to carefully read the documentation <i>could</i> or <i>might</i> put you at risk for a physical injury.
	<b>TOXIC SUBSTANCES HAZARD:</b> Indicates that exposure to a toxic substance could occur and that exposure <i>could</i> or <i>might</i> cause personal injury or death.
	For the prevention of personal injury, this general warning symbol precedes the <b>WARNING</b> safety alert word and meets the ISO 3864-2 standard. In the vocabulary of ANSI Z535 signs, this symbol indicates a possible personal injury hazard exists if the instrument is improperly used or if unsafe actions occur. This symbol and another appropriate safety symbol alerts you to an imminent or potential hazard that <i>could cause personal injury</i> .

Tous les symboles de sécurité sont suivis des mots **AVERTISSEMENT** ou **ATTENTION**, qui indiquent le degré de risque de blessures personnelles, de dommages à l'instrument, ou des deux. Les mentions « Attention » et les avertissements sont suivis d'un descripteur. Un **AVERTISSEMENT** vise à empêcher des actions inappropriées pouvant entraîner des blessures personnelles. Une mention **ATTENTION** vise à empêcher des actions inappropriées pouvant entraîner des blessures personnelles ou des dommages à l'instrument. Vous pouvez trouver les symboles de sécurité suivants sur votre instrument ou dans ce guide.

Symbol	Descriptor
	<b>RISQUE BIOLOGIQUE :</b> indique qu'un risque biologique va, peut ou pourrait survenir.
	<b>RISQUE DE BRÛLURE :</b> vous avertit de la présence d'une surface chaude qui peut ou pourrait entraîner des blessures par brûlure.
	<b>RISQUE D'ÉLECTROCUTION :</b> indique qu'un choc électrique peut ou pourrait survenir.

Symbol	Descriptor
	<b>RISQUE D'INCENDIE</b> : indique qu'un risque d'incendie ou d'inflammabilité peut ou pourrait survenir.
	<b>RISQUE DE GAZ INFLAMMABLE</b> : vous avertit que des gaz sont comprimés, liquéfiés ou dissous sous pression et qu'ils peuvent s'enflammer au contact d'une source d'inflammation. Ce symbole indique que ce risque peut ou pourrait entraîner une blessure physique.
	<b>GANTS REQUIS</b> : indique que vous devez porter des gants pour effectuer une tâche, sans quoi une blessure physique peut ou pourrait survenir.
	<b>RISQUE PHYSIQUE ET CHIMIQUE</b> : indique que des dommages chimiques ou une blessure physique peuvent ou pourraient survenir.
	<b>DOMMAGES À L'INSTRUMENT</b> : indique que l'instrument ou le composant pourrait subir des dommages. Ces dommages pourraient ne pas être couverts par la garantie standard.
	<b>RISQUE SOULÈVEMENT</b> : indique qu'une blessure physique peut ou pourrait survenir si un objet n'est pas soulevé par deux personnes ou plus.
	<b>RISQUE MATÉRIEL ET YEUX</b> : indique que des dommages aux yeux peuvent ou pourraient survenir.
	<b>RISQUE RADIOACTIF</b> : indique qu'une exposition à des matériaux radioactifs peut ou pourrait survenir.
	<b>CONSULTER LE MANUEL</b> : vous avertit de lire attentivement la documentation de votre instrument afin de garantir votre sécurité et la capacité opérationnelle de l'instrument. Ne pas lire attentivement la documentation peut ou pourrait vous exposer à un risque de blessure physique.

Symbol	Descriptor
	<b>RISQUE DE SUBSTANCES TOXIQUES</b> : indique que l'exposition à une substance toxique peut survenir et que l'exposition peut ou pourrait entraîner des blessures personnelles ou la mort.
	Pour prévenir les blessures personnelles, ce symbole général d'avertissement précède le mot <b>AVERTISSEMENT</b> et est conforme à la norme ISO 3864-2. Dans le vocabulaire des signes ANSI Z535, ce symbole indique un risque de blessures personnelles si l'instrument est utilisé de manière inappropriée ou en cas d'actions dangereuses. Ce symbole et un autre symbole de sécurité approprié vous avertissent d'un risque imminent ou potentiel pouvant entraîner des blessures personnelles.

## Hydrogen Safety Precautions

Hydrogen is a colorless, odorless, highly flammable gas with the molecular formula  $H_2$  and an atomic weight of 1.00794, making it the lightest element. Hydrogen gas presents a hazard as it is combustible over a wide range of concentrations: at ambient temperature and pressure, this ranges from about 4% to 74.2% by volume.

Hydrogen has a flash point of - 423 °F (- 253 °C) and an auto-ignition temperature of 1,040 °F (560 °C). It has a very low ignition energy and the highest burning velocity of any gas. If hydrogen is allowed to expand rapidly from high pressure, it can self-ignite. Hydrogen burns with a flame that can be invisible in bright light.



**WARNING FIRE HAZARD:** The use of hydrogen as a carrier gas is dangerous. Hydrogen is potentially explosive and must be used with extreme care. Any use of hydrogen gas must be reviewed by appropriate health and safety staff and all installations of hydrogen systems must be performed to applicable codes and standards. Thermo Fisher Scientific assumes no liability for the improper use of hydrogen as a carrier gas.



**AVERTISSEMENT RISQUE D'INCENDIE** : l'utilisation d'hydrogène comme gaz vecteur est dangereuse. L'hydrogène est potentiellement explosif et doit être utilisé avec une extrême précaution. Toute utilisation d'hydrogène gazeux doit être évaluée par le personnel de santé et de sécurité approprié et toutes les installations de systèmes d'hydrogène doivent se conformer aux codes et aux normes en vigueur. Thermo Fisher Scientific décline toute responsabilité en cas d'utilisation inappropriée d'hydrogène comme gaz vecteur.

Before you begin using hydrogen, you should conduct a risk assessment based on the quantity of hydrogen to be used and the conditions of your laboratory. You should ask yourself:

“What hydrogen hazards associated with this project are most likely to occur?”

“What hydrogen hazards associated with this project have the potential to result in the worst consequences?”

- Try to reduce or eliminate the higher risks by using the proper ventilation to remove hydrogen gas before an ignitable concentration can accumulate. You should also consider purging the hydrogen to further reduce hazards and ensure anyone who will be working with hydrogen has basic hydrogen safety training.
- As with laboratory safety in general, be sure to wear safety glasses, laboratory coats, gloves, etc. Typically there are no specific requirements for gaseous hydrogen, other than eye protection when working with a compressed gas. If working with liquid (cryogenic) hydrogen, insulated gloves and protective shoes should be worn in addition to eye protection.
- You should post “No Smoking” and “No Open Flames” signs to identify hydrogen sources and cylinders. Maintain, inspect and leak-test all hydrogen sources regularly.
- All hydrogen shutoff valves should be clearly marked and permanent hydrogen piping should be labeled as such at the supply or discharge point and at regular intervals along its length. Where hydrogen gas piping passes through a wall, the piping should be labeled on both sides of the wall.
- There should also be contingency plans in place should an incident occur.
- The site emergency response team, as well as the local fire department, should know the location of all hydrogen storage tanks.

## Using Hydrogen with a GC-MS/MS System

To use hydrogen with the mass spectrometer, you must always shut off the GC carrier gas before venting or turning off the mass spectrometer. There are three hydrogen safety screws on the mass spectrometer that **must** be in place. These are attached to your instrument at the factory.

**Figure 1.** Hydrogen Safety Screws on the Mass Spectrometer



Before powering on the GC-MS/MS system, ensure that:

- All the covers and panels of the GC-MS/MS system are firmly attached.
- The vent valve is tightly closed if you vented the system.
- All fittings, ferrules, and o-rings are sealed.

## Hydrogen Connection Guidelines

Use the following guidelines to safely connect hydrogen to your system:

- **Piping**—Hydrogen must be delivered to equipment using appropriate piping and be done in such a way as to pose essentially no hazard to end-users. Piping systems for the delivery of hydrogen should be designed and installed by a person qualified by specific training and experience with hydrogen piping systems.

Stainless steel is usually recommended because it is a safe, cost-effective material. Piping of *black iron* or copper must not be used, as the pipe can become brittle with age. Elastomeric/plastic tubing of various plastics and polymers should not be used, unless the tubing is approved for use with hydrogen. If elastomeric/plastic tubing is used for hydrogen gas delivery, the tubing should be tested for hydrogen permeability to minimize leakage.

The hydrogen piping system must be flexible enough to endure routine thermal expansion and contraction. The system should also include considerations for the most severe condition of temperature and pressure expected during service. Piping and supports must be able to withstand static loading introduced by such things as ice and snow; and dynamic loading from high wind and earthquake.

Caution should be used if burying hydrogen piping. Proper controls should be used to protect against damage and corrosion, and also to prevent Hydrogen from entering a building if there is any leakage.

- **Fittings**—All fittings must be of the proper type approved or designed for use with hydrogen gas. Use as few fittings as possible to minimize the potential for leaks. After installation, ensure that leak testing is carried out prior to system use, and on a regular basis.

There must be no PTFE tape or other things like *plumber's putty* used to enhance a seal, as this actually is a detriment to a good seal. Ideally the best installation would use stainless steel tubing with appropriate gas-tight fittings.

Welding is usually preferred for joints in hydrogen piping systems since welding provides a better connection and reduces the potential for leaks compared to mechanical fittings. Soft solder joints are not permitted for hydrogen systems (due to the low melting point of soft solder and its potential for brittle failure at cryogenic temperatures). Brazed joints are permitted, but such joints should be protected against the possibility of external fire.

Tubing connections should be clamped to barbed or press-fit type connections. Hose clamps or *jubilee clamps* must not be used.

- **Valves**—All valves must be suitable for hydrogen service and for the specific operating conditions. Valves, including regulators, must not be used for hydrogen, unless they are designed and identified for such a use. Ball valves are often chosen because of their superior leak tightness through the valve seat. Pneumatic operators are usually chosen for remotely operated valves so that potential ignition sources (electricity) are remote from the valve.

Manual shutoff valves should be provided near each point of use, within immediate reach. If a hydrogen cylinder or hydrogen generation system is located within immediate reach, a separate point-of-use shutoff valve is usually not necessary.

Line regulators that have their source away from the point of use should have a manual shutoff valve near the point of use.

An emergency gas shutoff device in an accessible location outside the use area should be provided in addition to the manual point-of-use valve in each educational and instructional laboratory space that has a piped gas supply system.

If necessary, the piping system should have uninterruptible pressure relief. The pressure relief system should be designed to provide a discharge rate sufficient to avoid further pressure increase and should vent to a safe location outside or to a ventilation system exhaust.

## Purchasing Hydrogen

Use the following guidelines when purchasing hydrogen:

- **Hydrogen Generator**—Because it minimizes the amount of hydrogen present and reduces the degree of hazard, a hydrogen generator (also called an electrolyzer) is the safest way to purchase hydrogen in the quantity used in GC/MS.

However, to minimize the degree of hazard, the hydrogen generator must only be operated in a non-explosive environment because hydrogen buildup can be ignitable. This means that your ventilation system for the room or lab hood must maintain an air exchange rate that is at least two orders of magnitude greater than the maximum hydrogen production rate of the hydrogen generator. Be sure to follow the manufacturers' directions about proper use and maintenance of the regulator.

To prevent the possibility of releasing hydrogen, the hydrogen generator should be set to shut down if:

- There is a loss of flow to the ventilation system
- A hydrogen detector alarms at 25% of the lower flammable limit of hydrogen in air.

The oxygen exhausted by the electrolyzer should be vented to the outside as well.

- **Hydrogen Cylinder**—Hydrogen can be delivered in standard laboratory gas bottles or cylinders. These cylinders have a limited amount of hydrogen in them and are a safe way to transport and store hydrogen. However, compressed hydrogen gas cylinders, like all compressed gas cylinders, must be secured in an upright position, ideally with a non-combustible chain or cable. If the cylinder falls over, the valve can be knocked off and the pressurized cylinder can take off like a rocket, which leads to the release of hydrogen and possibly an explosion, severe injury, or death. Never crack a hydrogen cylinder valve to remove dust or dirt from fittings prior to attaching a regulator, as there is a risk of self-ignition.

## Properly Storing Hydrogen

Storing and handling compressed hydrogen gas and cryogenic liquid hydrogen present potential health and safety hazards. Using proper storage and handling techniques is essential to maintaining a safe work environment.

Use the following guidelines when storing hydrogen:

- Store spare hydrogen gas cylinders outside and away from doors, windows, building air intake vents, structures, and vehicle routes. This precaution applies when the hydrogen is or is not in use. Indoor storage of spare hydrogen cylinders has special requirements, which is beyond the scope of this document. Documentation for each vessel should include a description of the vessel, a list of available drawings or other documents, the most recent inspection results, and the responsible person's name.
- Prevent spare cylinders from toppling by wrapping them with chains. The chains should also be protected against corrosion and excessive heat.



- Separate spare hydrogen cylinders from oxidizing gases (such as oxygen) with a 5 ft (1.5 m) tall fire barrier with a half-hour fire rating or place the cylinders at least 20 ft (6 m) apart.
- When moving hydrogen cylinders:
  - Remove the regulator and replace the cylinder valve cap before moving.
  - Move cylinders on cylinder carts or with other appropriate transport devices.
  - Never roll or drop a cylinder and never lift a cylinder by its protective cap.
- Bulk hydrogen systems include either gaseous or liquid hydrogen in fixed installations; in some gas systems a semi-permanent trailer (tube trailer) can be used. Storage vessels for compressed hydrogen gas or liquid hydrogen should be designed, constructed, tested, and maintained in accordance with applicable codes and standards. Bulk hydrogen systems represent a level of complexity again which is beyond the scope of this document; however some general guidelines are provided.
- The bulk hydrogen storage system should not be located beneath electric power lines, close to other flammable gases/liquids, or close to public areas. It should be readily accessible to authorized personnel and delivery equipment, but protected from physical damage or tampering.
- As liquid hydrogen systems also have a cryogenic hazard, additional safety considerations for the use of cryogenic liquids might be necessary.

## Hydrogen Safety Codes, Standards and References

The following list of safety codes, standards and references is in no way an exhaustive list. In fact, there might be federal, state or local codes that apply to your specific location. Check with all appropriate agencies with jurisdiction before installing or using a hydrogen system.

- Air Products Safetygram #4 Gaseous Hydrogen
- ANSI/AIAA standard for hydrogen safety guidelines is AIAA G-095-2004, Guide to Safety of Hydrogen and Hydrogen Systems
- ASME B31.1, Power Piping Code
- ASME B31.3, Process Piping Code
- ASME B31.8, Gas Transmission and Distribution Systems
- BCGA Code Of Practice CP4 Industrial Gas Cylinder Manifolds and Gas Distribution Pipework
- BCGA Code Of Practice CP33 The Bulk Storage of Gaseous Hydrogen at Users' Premises
- CGA G-5, Hydrogen
- CGA G-5.4, Standard for Hydrogen Piping Systems at Consumer Locations
- CGA G-5.5, Hydrogen Vent Systems
- CGA G-5.6, Hydrogen Pipeline Systems
- CGA G-5.8, High Pressure Hydrogen Piping Systems at Consumer Locations.
- FM Global Property Loss Prevention Data Sheets 7-50: Compressed Gases in Cylinders
- FM Global Property Loss Prevention Data Sheets 7-91: Hydrogen
- IGC Doc 121/04/E, Hydrogen Transportation Pipelines System Design Features
- NASA
- NSS 1740.16 Safety Standard For Hydrogen And Hydrogen Systems Guidelines for Hydrogen System Design, Materials Selection, Operations, Storage, and Transportation
- NFPA 52, Vehicular Fuel Systems Code
- NFPA 55, Standard for the Storage, Use, and Handling of Compressed Gases and Cryogenic Fluids in Portable and Stationary Containers, Cylinders, and Tanks, 2005 Edition
- NFPA 68, Standard on Explosion Protection by Deflagration Venting
- NFPA 70, National Electrical Code

- NFPA 497, Recommended Practice for the Classification of Flammable Liquids, Gases, or Vapors and of Hazardous (Classified) Locations for Electrical Installations in Chemical Process Areas
- NFPA 13, Standard for the Installation of Sprinkler Systems
- NFPA 45, Standard on Fire Protection for Laboratories Using Chemicals
- NFPA 55, Standard for the Storage, Use, and Handling of Compressed Gases and Cryogenic Fluids in Portable and Stationary Containers, Cylinders, and Tanks
- NFPA 68, 2007 Standard on Explosion Protection by Deflagration Venting
- NFPA 69, Standard on Explosion Prevention Systems
- NFPA 91, Standard for Exhaust Systems for Air Conveying of Vapors
- NFPA 255, Standard Method of Test of Surface Burning Characteristics of Building Materials
- OSHA 29CFR1910.103 1910.103 Hydrogen

## Hazardous Substances Precautions



**WARNING** Before using hazardous substances (toxic, harmful, and so on), please read the hazard indications and information reported in the applicable Material Safety Data Sheet (MSDS). Use personal protective equipment according to the safety requirements.



**AVERTISSEMENT** Avant d'utiliser des substances dangereuses (toxiques, nocives, etc.), veuillez lire attentivement les indications et informations relatives au risque reprises sur la fiche de données de sécurité adéquate. Utilisez un équipement de protection individuelle conformément aux exigences de sécurité.

## Biological Hazard Warning Note

In laboratories where samples with potential biological hazards are handled, the user must label any equipment or parts which might become contaminated with biohazardous material.

The appropriate warning labels are included with the shipment of the instrument. It is the user's responsibility to label the relevant parts of the equipment.

When working with biohazardous materials, you are responsible for fulfilling the following mandatory requirements:

- Providing instructions on how to safely handle biohazardous material.
- Training operators to be aware of potential hazards.
- Providing personal protective equipment.
- Providing instructions for what to do if operators are exposed to aerosols or vapors during normal operation (within the intended use of the equipment) or in case of single fault situations such as a broken vial. The protective measures must consider potential contact with the skin, mouth, nose (respiratory organs), and eyes.
- Providing instructions for decontamination and safe disposal of relevant parts.



**WARNING** The user or operator is responsible for the safe handling of hazardous chemicals or biological compounds including (but not limited to) bacterial or viral samples and the associated waste, according to international and local regulations.



**AVERTISSEMENT** L'utilisateur ou l'opérateur est responsable de la manipulation sûre des composés chimiques et biologiques dangereux, y compris, sans s'y limiter, les échantillons bactériens ou viraux et les déchets associés, conformément aux réglementations internationales et locales.



## Venting Toxic Gases

When analyzing toxic compounds, be aware that during the normal operation of the GC some of the sample might be vented outside the instrument through the split and purge flow vents; therefore, be sure to vent the exhaust gases to a fume hood. Consult local environmental and safety regulations for instructions in exhausting fumes from your system.

## Contacting Us

There are several ways to contact Thermo Fisher Scientific for the information you need.

❖ **To find out more about our products**

Go to [www.thermofisher.com](http://www.thermofisher.com) for information about our products.

❖ **To access product documentation**

Go to [docs.thermofisher.com](http://docs.thermofisher.com)

❖ **To get local contact information for sales or service**

- Go to [gcgcms.freshdesk.com/support/home](http://gcgcms.freshdesk.com/support/home)



# Introduction

Use the information in this chapter to determine whether your TSQ 9610 system is working properly and to check its basic systems.

**IMPORTANT** You will likely want to change the GC column before setting up a method. See [Chapter 2, “Changing the Column,”](#) for instructions on changing the column.

## Contents

- [Confirming Your Instrument is Working](#)
- [Checking Power to the System](#)
- [Verifying the Carrier Gas Flow Rate](#)
- [Checking Your Carrier Gas Supply Pressure](#)
- [Verify Collision Gas Supply Pressure](#)
- [Checking the Vacuum and Temperature](#)
- [Cleaning the Exterior of Your Instrument](#)
- [Configuring Your Instrument](#)

## Confirming Your Instrument is Working

After installing a new column, confirm that your GC/MS-MS system has power, the carrier gas flow and collision gas delivery pressure are correct, the gas supplies have enough pressure, and the system is leak-free and has reached vacuum and temperature.

### Checking Power to the System

To confirm that the TSQ 9610 system is powered on, check that the power light on the front panel is lit and solid green. See [Figure 1](#). If it is not, the instrument is not powered on. The mass spectrometer (MS) with foreline pump (system mech pump) must be on its own dedicated circuit with supply voltage matching the pump requirements.

## 1 Introduction

Confirming Your Instrument is Working

### ❖ To power on the TSQ 9610 instrument

Lift up the power switch located on the upper left side panel of the instrument near the back.

**Figure 1.** Front Panel of the TSQ 9610 Instrument (with VPI)



### ❖ To power on the TRACE 1600/1610 GC

Reach over the top right of the instrument and pull up on the large plastic ribbed power switch on the back.

### ❖ To confirm that a TRACE 1600 is powered on

Confirm that the power light on the status panel is solid green.

### ❖ To confirm that a TRACE 1610 is powered on

Confirm that the touchscreen main menu has appeared.

## Verifying the Carrier Gas Flow Rate

Once you confirm that the system is powered on, verify that the carrier gas rate is correct.

### ❖ To check the carrier gas flow rate on the TRACE 1610 GC

1. Choose Instrument Control and then Front/Back inlet.
2. Display the column flow.

If the actual and set point amounts in **Col. Flow** are the same, then you have good carrier gas flow. If the amounts are different, refer the Troubleshooting section of the *TRACE 1600/1610 GC Series User Guide*.



❖ **To check the carrier gas flow rate on a TRACE 1600**

1. On a TRACE 1600 GC, open the Xcalibur software by clicking on the Xcalibur icon on the computer desktop. On the Xcalibur roadmap, select the TRACE 1600 from the instrument list in the side panel. This opens the **Status Panel**.
2. Display the column flow.
3. Verify the column flow rate under the **Flow** tab in the Real Time Status pane.
4. If the actual and set point amounts in **Col. Flow** are the same, then you have good carrier gas flow. If the amounts are different, see the troubleshooting section of your GC user documentation.

## Checking Your Carrier Gas Supply Pressure

Make sure you have enough pressure in the carrier gas supply to accommodate the number of samples you plan to run. If the pressure is too low, you might run out of gas in the middle of a run, which could compromise the results of your data.

❖ **To check your carrier gas supply pressure**

1. Locate your carrier gas supply. It might be in a different room, depending on how your lab is set up.
2. Look at the pressure gauge on the supply.
3. Ensure the pressure is more than 100 psi at the primary (or first) regulator stage. If it is not, you may want to replace the supply if you have to run a lot of samples.

## Verify Collision Gas Supply Pressure

Check that the input pressure of your collision gas is at 59–61 psig for Argon or 56–58 psig for Nitrogen and that the supply is connected to the mass spectrometer.



**CAUTION** Collision gas input pressure must remain constant for proper instrument performance. The regulator used to supply the collision gas must be able to deliver  $60 \pm 1$  psig. Ensure that the regulator is marked clearly at 60 psig and is stable enough to supply constant pressure at  $60 \pm 1$  psig.



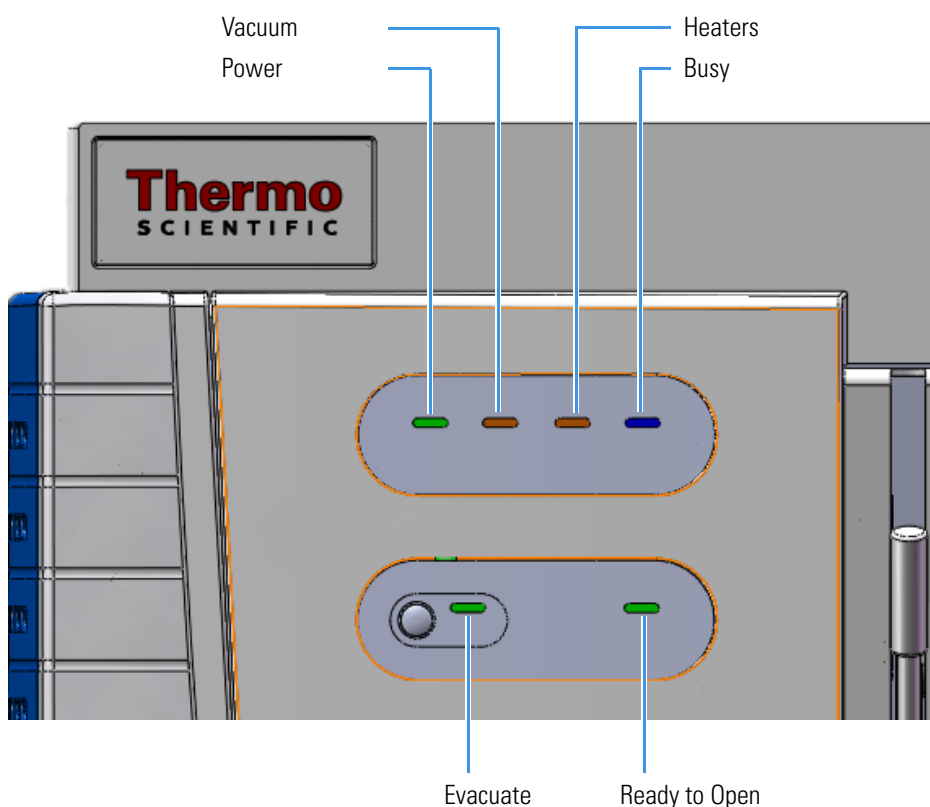
**ATTENTION** La pression d'entrée du gaz de collision doit rester constante pour garantir les bonnes performances de l'instrument. Le régulateur utilisé pour approvisionner le gaz de collision doit être capable de fournir  $60 \pm 1$  psig. Assurez-vous que le régulateur est clairement marqué à 60 psig et est suffisamment stable pour fournir une pression constante à  $60 \pm 1$  psig.

## Checking the Vacuum and Temperature

Use the lights on the front of your TSQ 9610 system to check the vacuum and temperature of the instrument.

To check the vacuum, look at the **Vacuum** light. See [Figure 2](#). When the light is a solid green, the mass spectrometer is under sufficient vacuum. If the Vacuum light is slowly blinking orange, you have not yet achieved vacuum. If the Vacuum light is blinking orange quickly, you have a large leak that has prevented the instrument from achieving vacuum. In this case, you must turn the power off and find and fix the leak. Most likely, the column nut must be tightened, the column was not installed correctly, or the vent valve was not completely closed. See [Troubleshooting](#) for more information.

**Figure 2.** Using the Lights on the TSQ 9610 Instrument

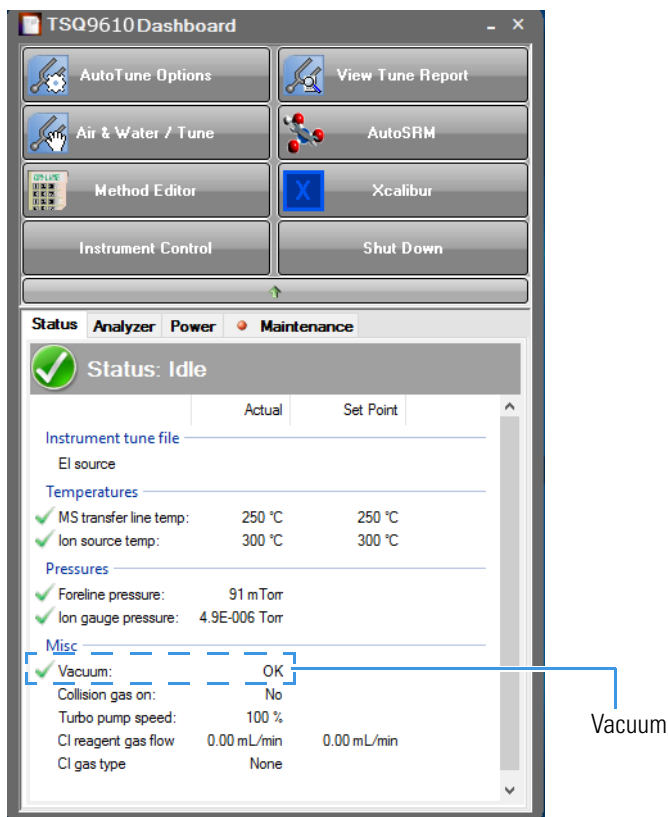


To check the temperature, look at the Heaters light. When the Heaters light is a solid green, the GC-MS/MS system is at temperature. If the Heaters light is blinking orange, the ion source, ion optics and/or transfer line are not at temperature. If the Heaters light is not lit, the heaters are not turned on.

**Note** Until the Vacuum light is a solid green (high vacuum is achieved), the heaters will not power on and the Heaters light will not be lit.

You may also use the TSQ Series Dashboard installed with Xcalibur instrument driver installations to check the vacuum of your system. If your system has achieved sufficient vacuum, a green check mark appears next to **Vacuum** on the dashboard. See [Figure 3](#)

**Figure 3.** Checking System Vacuum on the Dashboard



If you are running Chromeleon software, check the system vacuum in the **Detector-Service** utility. See [Figure 4](#).

**Figure 4.** Checking the Vacuum in Chromeleon Software



## Cleaning the Exterior of Your Instrument

When the exterior of your instrument gets dirty, wipe it with a clean, dry, lint-free cloth.

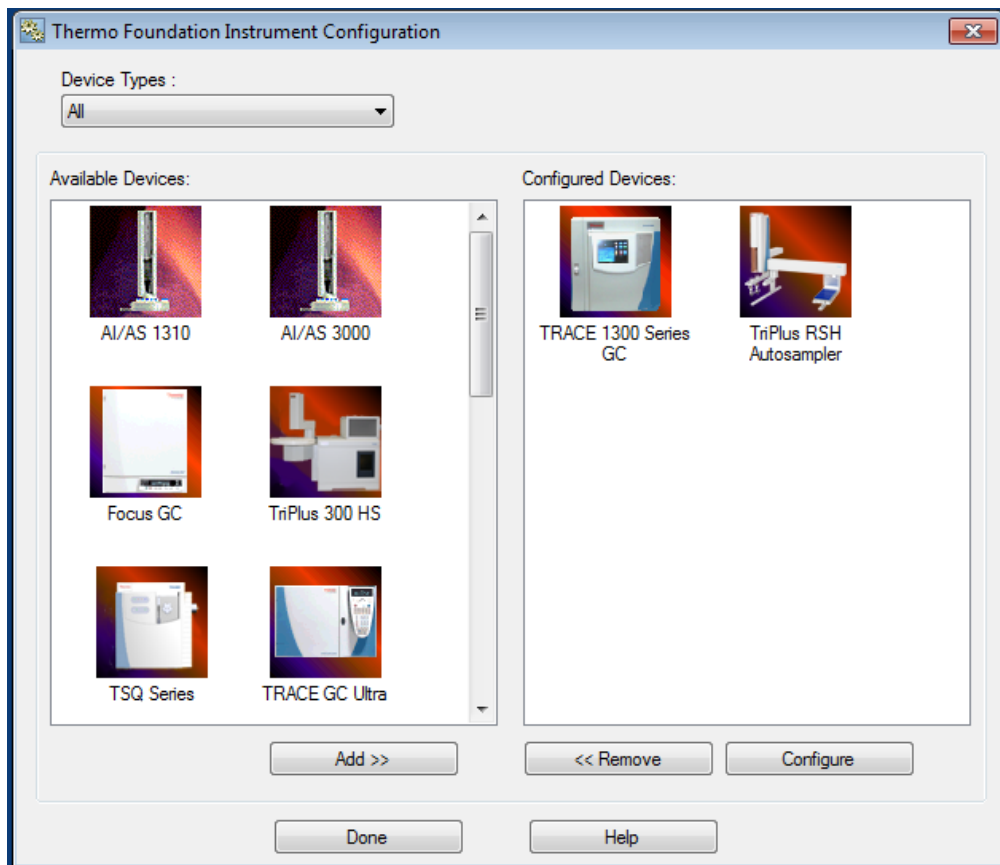
## Configuring Your Instrument

Initially, the field service engineer will configure your TSQ 9610 instrument. However, if you have reinstalled the software or you have a new computer or device, follow these instructions to reconfigure it.

### ❖ To configure your TSQ 9610 instrument

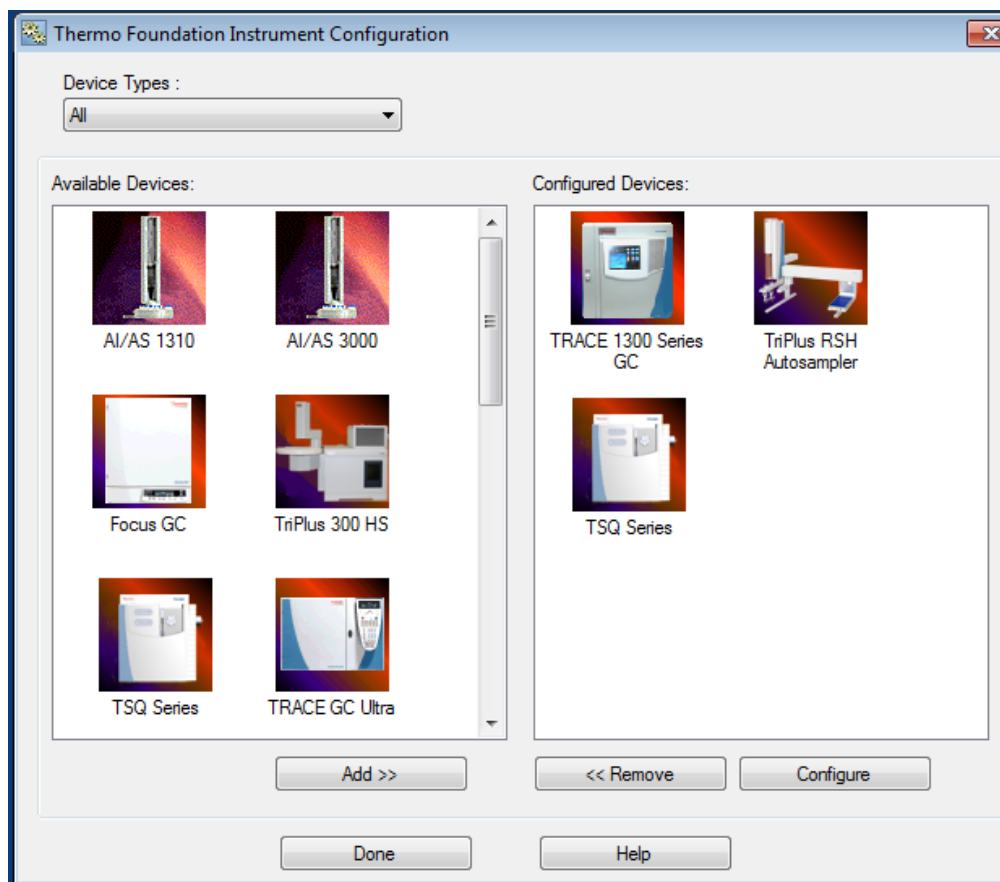
1. If you are running Xcalibur software, close the Dashboard and any open Xcalibur windows.
2. From the Start menu on your computer, choose **Start | Thermo Foundation | Instrument Configuration**.
3. When the Instrument Configuration window opens, you will see icons of all connected instruments.
4. Select the TSQ Series icon in the Available Devices column and click **Add** to move it into the Configured Devices column.

Figure 5. Finding Available Devices



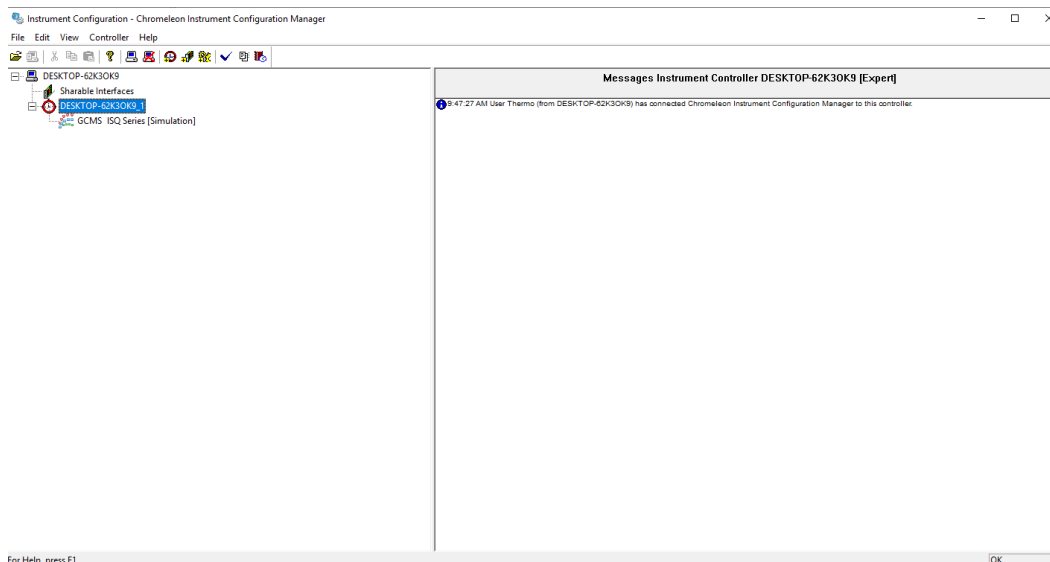
5. Select the icon for each instrument you want to configure (See [Figure 6](#)) and click **Add**.

Figure 6. Configuring a Device



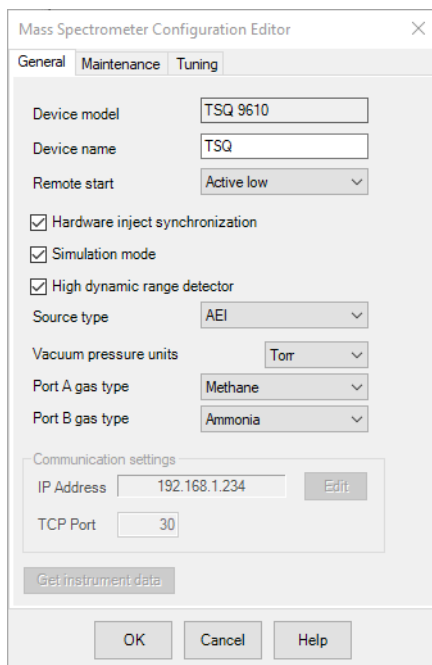
6. Select the TSQ Series from the list of configured devices.
7. Click **Configure** to open the TSQ Series Configuration dialog box.
8. If you are running Chromeleon software on your system, click the Chromeleon Instrument Configuration Manager icon on your desktop to open the Chromeleon instrument configuration manager. See [Figure 7](#).

**Figure 7.** Opening the Chromeleon Instrument Configuration Manager



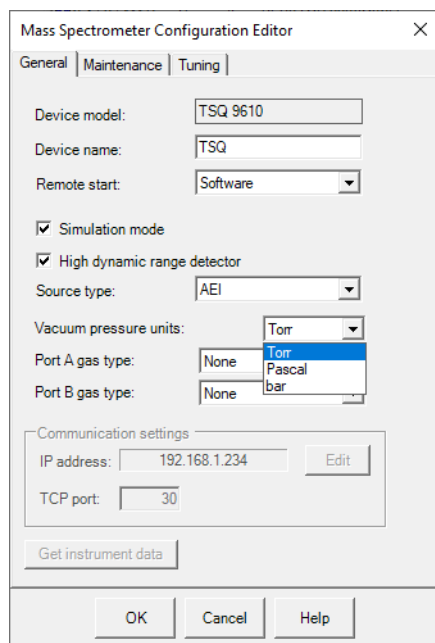
9. Click the instrument name in left pane to open the Mass Spectrometer Configuration Editor. See [Figure 8](#).

**Figure 8.** Viewing the Mass Spectrometer Configuration Editor



10. In the General page, set the pressure units. The choices are **Torr**, **Bar**, or **Pa**. See [Figure 9](#).

**Figure 9.** Setting the Pressure Units

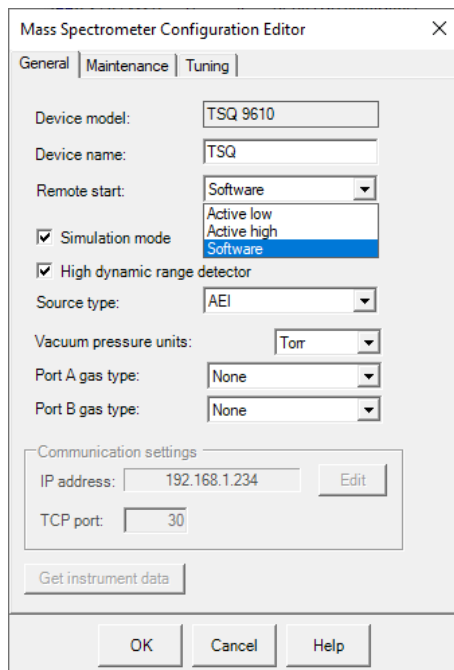


**Note** You only need to set up the pressure units if you have an ion gauge or convectron gauge installed on your system. The readbacks from these components will display in the units set in this dialog box.

11. Set the remote start, which tells the TSQ 9610 system when the GC has started a run. When you configure the GC, you can tell it what to send out to the instrument. Make sure the value in this dialog box matches what you set on the GC. The default is **Active Low**. See [Figure 10](#).

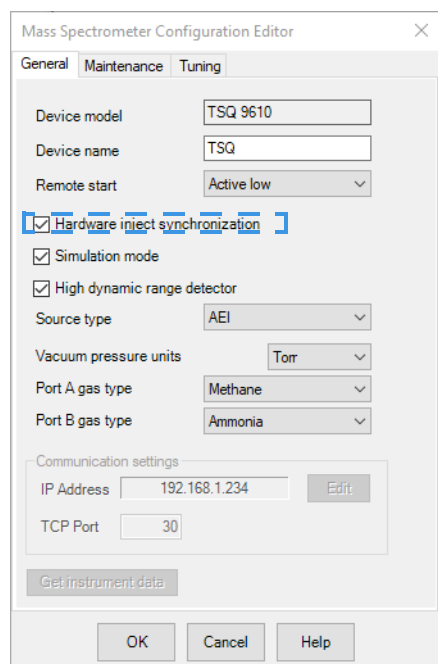


**Figure 10.** Setting the Remote Start



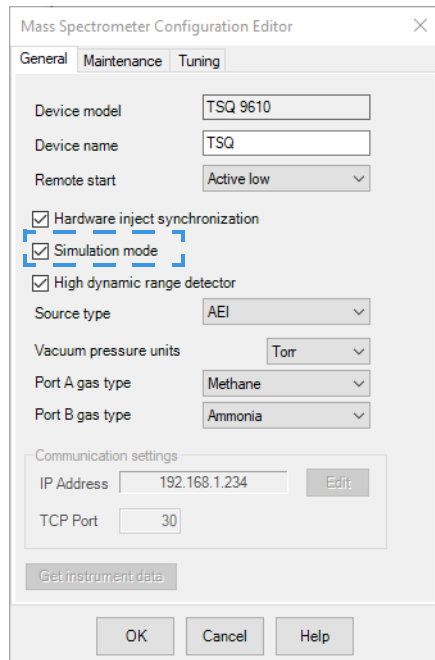
12. Check the **Hardware Inject Synchronization** box to set the instrument to inject with the GC settings. This box is checked by default. See [Figure 11](#).

**Figure 11.** Configuring Hardware Inject Synchronization



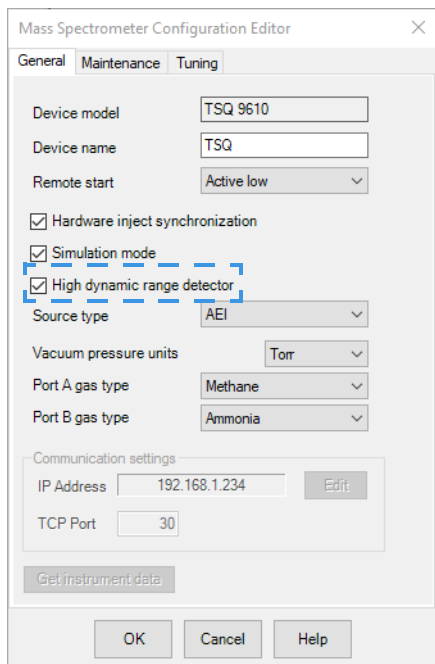
13. If you want to run the instrument in simulation mode, check the **Simulation Mode** box. See [Figure 12](#).

Figure 12. Setting the Simulation Mode



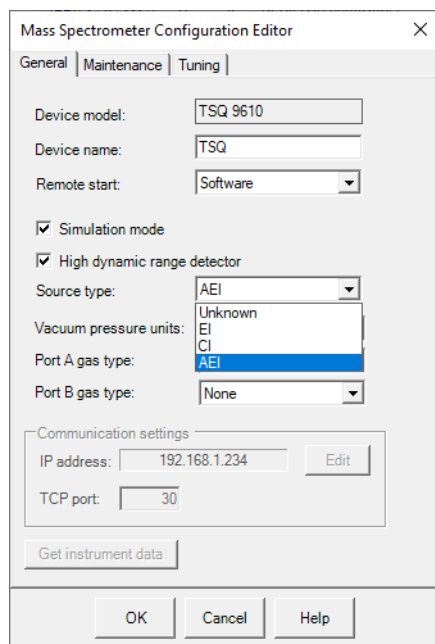
14. If the mass spectrometer is equipped with a high dynamic range electron multiplier, check the **High Dynamic Range Detection** box. See [Figure 13](#).

Figure 13. Configuring the High Dynamic Range



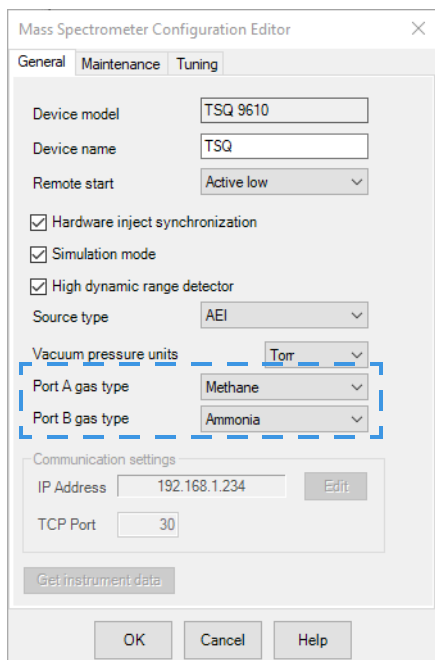
15. Configure the **Source Type**. The choices are **EI**, **CI**, or **AEI**. See [Figure 14](#).

**Figure 14.** Configuring the Ion Source Type



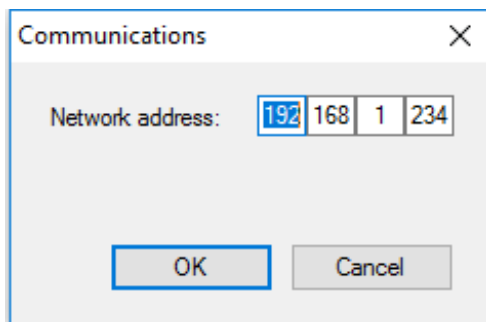
16. If a CI ion source is installed, set the CI gas types you are using in either **Port A Gas Type** or **Port B Gas Type**. See [Figure 15](#).

**Figure 15.** Configuring the CI Gas Ports



17. Click **Communications** and the **Edit** to reset the network IP address and assign a TCP port. See [Figure 16](#). This tells the instrument method how to find the TSQ 9610 system if you changed the IP address using Instrument Configuration. For security purposes, you may also want to modify the TCP port. Consult your local IT Department for help.

**Figure 16.** Setting up the Network

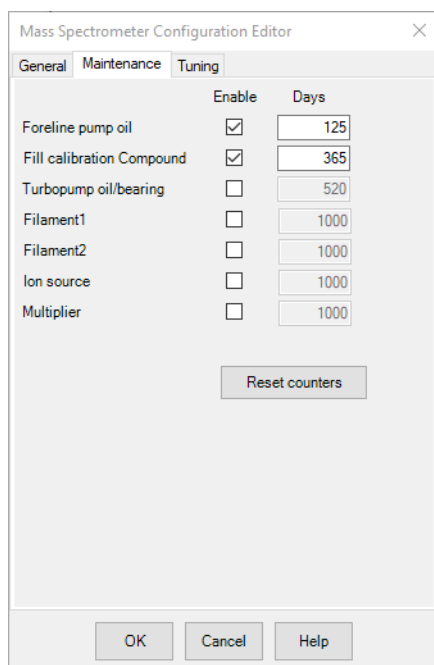


There is a reset button behind the front door of the ISQ 7610. Press and hold the reset button for more than 5 seconds to reset the instrument temporarily to the default IP address: 192.168.1.234. Make sure to send a known IP address to the instrument after reconnecting to the default IP address.

If the IP address is lost, follow the instructions below to recover the previous default IP address. Other network cards on the PC must be disabled or the network cables must be unplugged if the local network addresses begin with 192.168.1.

- a. Open the Instrument Configuration on the computer and configure the Mass Spectrometer Communications to IP address 192.168.1.234. Do not close Instrument Configuration.
  - b. Press and hold the front panel reset button located behind the door on the mass spectrometer for at least 5 seconds. This will boot the instrument from the backup flash memory and the instrument will communicate with the original default IP address (192.168.1.234).
  - c. Open the TSQ computer network card and reconfigure it to its original IP address (192.168.1.XYZ, where XYZ is not 234).
  - d. Press **OK** and right click the TSQ network card in the lower right corner of the desktop and select **Repair**.
  - e. Close Instrument Configuration.
18. Click the **Maintenance** tab to set the number of days until you plan to perform maintenance on certain components of your GC/MS system. See [Figure 17](#).

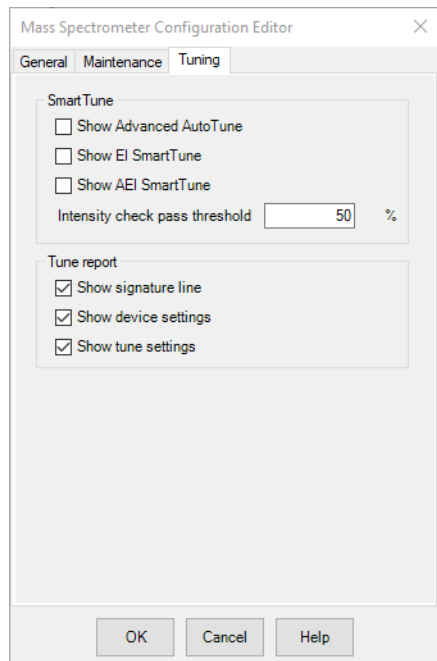
**Figure 17.** Setting the Maintenance Intervals



19. Select the **Foreline Pump Oil** check box to enable the maintenance intervals. Then set the number of days after which you want to be reminded to check the oil. The manufacturer recommends changing the oil every 125 days. Select the **Turbo Pump Oil/Bearing** check box to enable the maintenance reminder. Then set the number of days after which you want to be reminded to check the oil. Refer to the Turbo Pump manual for the manufacturer's recommended maintenance intervals.
20. Check the **Fill Calibration Compound** box to enable the maintenance intervals. Then set the number of days to elapse before refilling the calibration compounds. The suggested interval is 365 days.
21. Select the **Filament 1** check box to enable the maintenance reminder. In a leak-free system, expect the filament to last between 30-360 days, depending on usage.
22. Select the **Filament 2** check box to enable the maintenance reminder. Then set the number of days after which you want to be reminded to check filament 2. In a leak-free system, expect the filament to last between 30-360 days, depending on usage.
23. Select the **Ion source** check box to enable the maintenance reminder. Then set the number of days after which you want to be reminded to check the ion source. The time between cleaning depends very strongly on your analysis. You will have to determine the correct length of time between source cleanings.
24. Select the **Multiplier** check box to enable the maintenance reminder. Then set the number of days after which you want to be reminded to check the electron multiplier.
25. Click the **Tuning** tab and use the check boxes **Show Advanced AutoTune**, **Show EI SmartTune**, and **Show AEI SmartTune** to enable these applications in the software. You

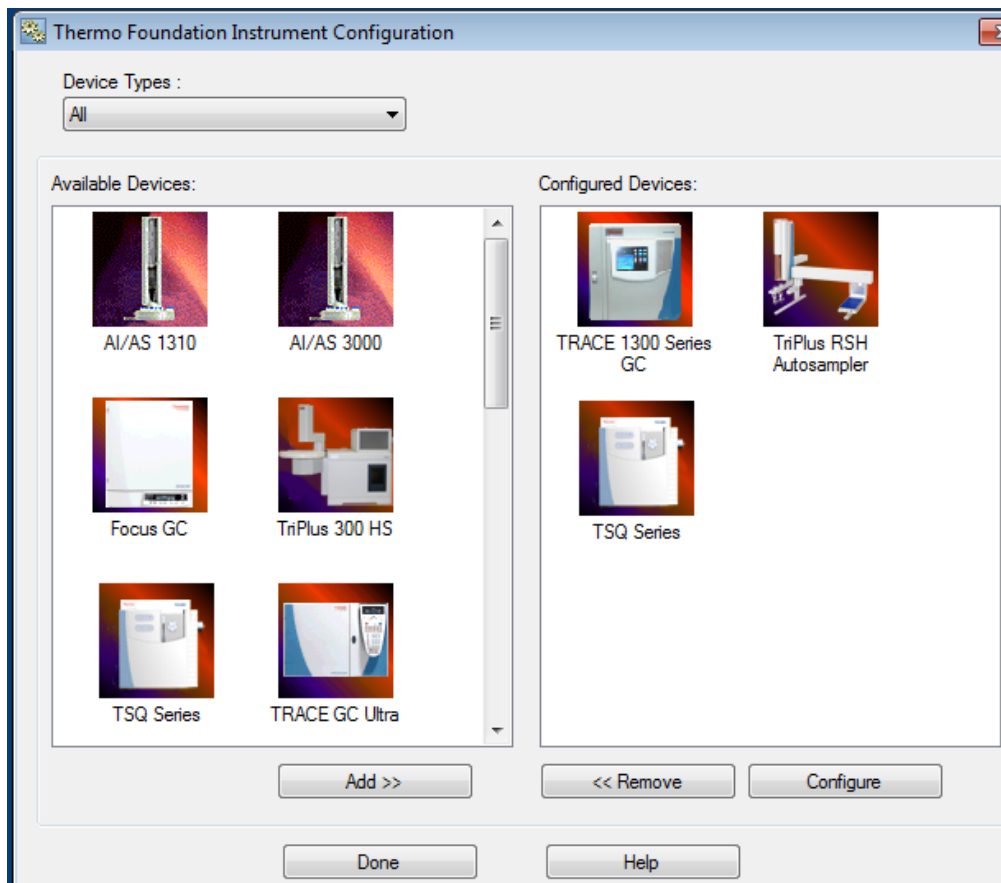
can also set the **Intensity Check Pass Threshold** and the **Tune Report** options here. See [Figure 18](#).

**Figure 18.** Setting the Tuning Options



26. Click **OK** to return to the main Instrument Configuration window in Xcalibur (see [Figure 19](#)) or the Instrument Configuration Manager window in Chromeleon (see [Figure 22](#)).

**Figure 19.** Main Instrument Configuration Window

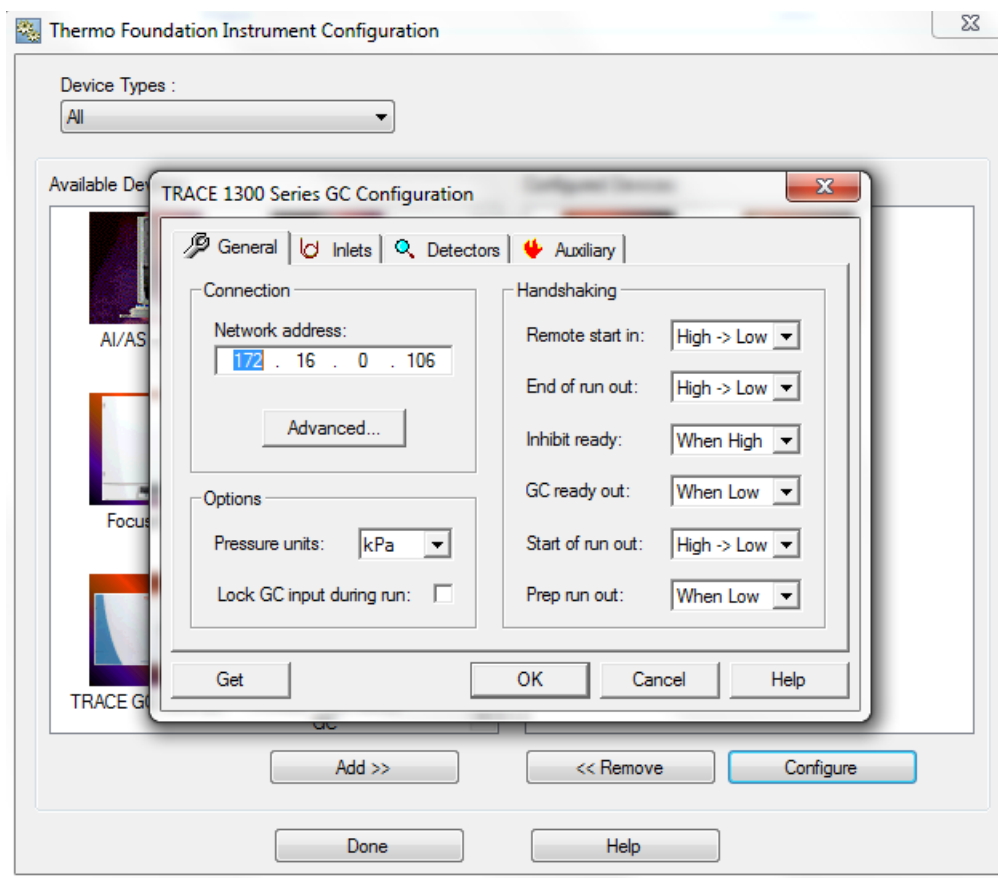


27. Select the TRACE 1600 or TRACE 1610 icon to configure the GC handshaking parameters.
28. Under the **General** tab, set the handshaking parameters as shown in [Table 1](#).

**Table 1.** GC Handshaking Parameters

Remote Start In	High to Low
Inhibit Ready In	When High
End of Run Out	High to Low
Start of Run Out	High to Low
GC Ready Out	When Low
Prep Run Out	When Low

Figure 20. GC Handshaking Parameter Configuration



29. Click **OK** once you have entered the correct GC handshaking parameters.

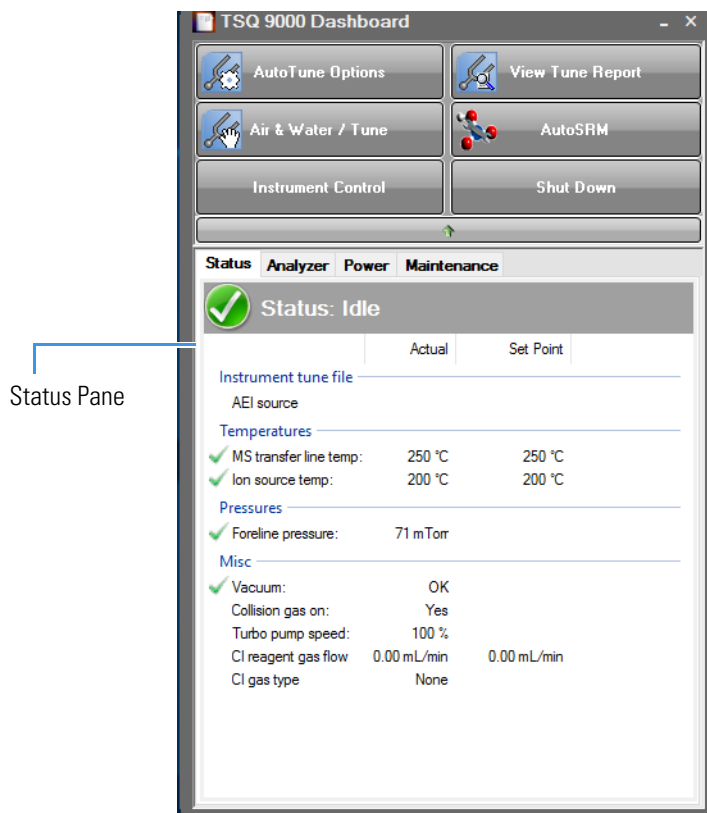
**Note** For the remainder of the GC configuration settings, refer to the *TRACE 1600 and TRACE 1610 Series GC User Guide*. Refer to your autosampler user documentation for the correct autosampler configuration settings.

**Note** If you are running samples with a Direct Probe System, you do not have to configure the GC.

30. Click **Done** to close the Instrument Configuration window.
31. Check the status of the configured instruments in the **Status Pane** of the TSQ Series Dashboard.

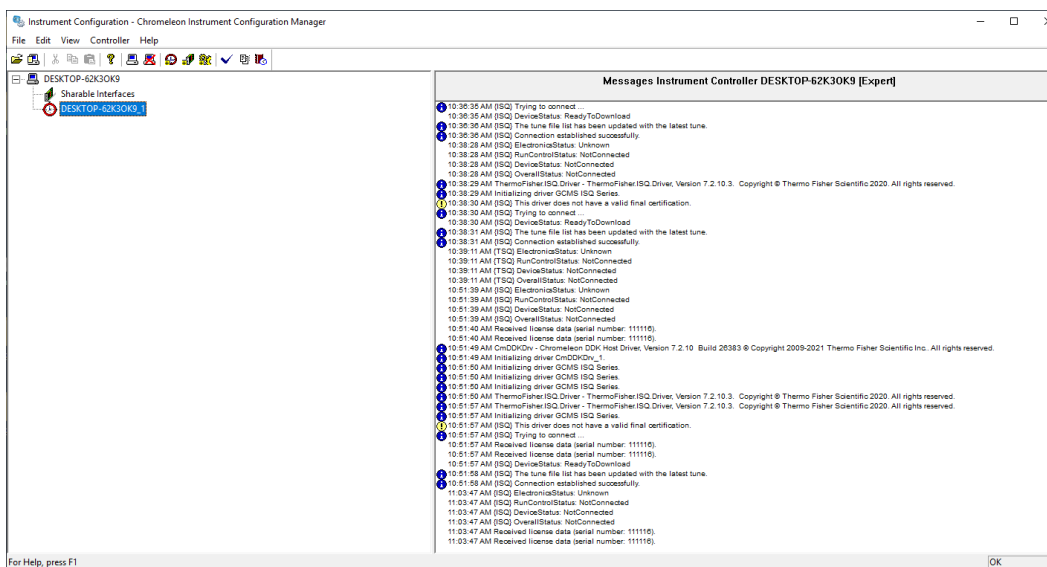


Figure 21. TSQ Series Dashboard



Status Pane

Figure 22. Instrument Configuration Manager in Chromeleon





## Changing the Column

The TSQ 9610 GC-MS/MS system ships with a factory-tested 15 m × 0.25 mm ID TG-SQC column, which the field service engineer uses to qualify the instrument. However, once it gets dirty, you cannot purchase a new one, so you must install a column that accommodates the type and quantity of samples that you will be running. For best results, choose a column that will give you the best possible resolution, analysis speed, and quantitation.

**Tip** If your system includes TRACE 1610 GC, there are videos included on the HMI touchscreen for changing the column with the various ion source types. Access the videos by clicking **Maintenance | Videos** on the HMI.

### Contents

- [Determining the Column Type](#)
- [Replacing the Factory Installed Column](#)

## Determining the Column Type

When determining the type of column for your particular needs, here are a few things to consider:

- **Column Material**—Columns made out of fused silica are economical and widely used. Columns made out of this material have a wide range of stationary phases and are available in many sizes that can be used with a mass spectrometer.

Large diameter columns made of steel are widely used in process gas analysis, but they are not typically used on mass spectrometers. There are also metal-clad, fused silica columns, which have the advantages of fused silica, but the metal makes them resistant to breakage. These columns are less common and more expensive.

- **Stationary Phase**—The stationary phase is the most important consideration when selecting a column. The interaction between the stationary phase and the analyte determines how well the analytes separate from each other (resolution) and also affects how quickly the separation occurs (analysis time). Choose a stationary phase that is compatible with the nature of your analytes and the maximum GC oven temperature that you will use.
- **Internal Diameter**—The smaller the diameter of the column, the better the separation. However, smaller diameter columns do not have as much capacity for matrix or analytes. As a result, smaller diameter columns are subject to overloading, which leads to retention time shifts and peak shape changes. Larger diameter columns can accept larger concentrations of material, but will require longer columns or slower GC oven temperature ramps (which increase the analysis time) to match the separation power of smaller-diameter columns. Typical column sizes for GC/MS have inside diameters (ID) of 0.25 mm. Smaller ID columns, such as the 0.18 and 0.10 mm, are becoming increasingly popular. Additionally, 0.32 and 0.53 mm ID columns are commonly used.
- **Film Thickness**—With larger film thicknesses, there is more capacity for the analyte. This capacity can aid in the separation of high concentration samples and in the separation of very volatile samples because thicker stationary phases allow more opportunities for the analytes to interact with the stationary phase. The optimal film thickness depends on the internal diameter of the column, and the maximum total capacity needed for sample analysis.

Thick films with small internal diameters give very strong interactions with the analytes, which can result in longer analysis time and peak tailing. Large ID columns with thin films have very little interaction with the analytes, which will result in very fast analysis times with little separation. Typical film thicknesses are 0.25  $\mu\text{m}$  for a column with an ID of 0.25 mm. Other common film thicknesses are 0.1, 0.5, and 1.0  $\mu\text{m}$ .

Be careful when selecting columns for mass spectrometers. Some columns with large inner diameters that work fine with other GC detectors may need lower head pressure when operated with vacuum at the outlet. This lower head pressure can allow air diffusion into the column through the carrier gas flow module's split and purge valves.

- **Length**—The length of the column affects how much time the analyte has to interact with the stationary phase. Longer columns typically have better resolutions and higher capacities, but longer analysis times. Longer columns are also more expensive. Typical column lengths are 15 or 30 m for GC/MS, but 100 m columns may be needed for very complex mixtures like gasoline. Very short columns (2.5, 5, and 10 m) are also available.

**Note** Contact your local sales representative to order a Thermo Scientific column. You can also refer to our catalog or visit our Web site at [www.thermofisher.com](http://www.thermofisher.com).

## Replacing the Factory Installed Column

The procedure for replacing a column depends on your system configuration. If your system does not have a VPI or has an AEI ion source installed, see [“Replacing a column in a TSQ 9610 system with no VPI or an Standard AEI ion source”](#) on page 23. If your TSQ 9610 MS has a vacuum probe interlock (VPI) and the ExtractaBrite ion source is installed, see [“Replacing a column on a TSQ 9610 system with a VPI and an ExtractaBrite ion source or a NeverVent AEI \(NVAEI\) ion source”](#) on page 33.

### Replacing a column in a TSQ 9610 system with no VPI or an Standard AEI ion source

If your TSQ 9610 system has no VPI or has a standard AEI ion source installed on the system, follow the instructions below to replace the column.

**Note** Some of the cleaning procedures in this section require the use of methanol. If methanol is unavailable or prohibited, substitute LCMS-grade or GC-grade ethanol or isopropyl alcohol. Do not use denatured ethanol as it may contain impurities that contaminate the GC-MS system.

❖ **To replace the factory-installed column in the TSQ 9610 system in a system with no VPI or with a standard AEI ion source installed**

**Note** If you are running samples, stop the acquisition before powering off the system.

1. Cool down the GC oven and injector. See the GC documentation for information.
2. Open the TSQ Series Dashboard and click **Shut Down**.  
  
During the shutdown procedure the vacuum and heaters lights will remain off. Once the procedure is complete and the instrument is ready to be powered off, the power light will turn amber and start blinking rapidly. At this point it is safe to power off the TSQ 9610 system.
3. On the left side of the instrument, push down on the power switch to power-off the TSQ 9610 system.
4. Open the front door of the instrument.
5. Look behind the right side of the vacuum interlock shield and twist the vent valve knob one and a half times in a counterclockwise direction to open the vent.
6. Remove the current column from the MS transfer line. To replace the column in the GC inlet, follow the instructions in [“Installing the Column in the GC Inlet”](#) on page 39.
7. Connect the column to the MS transfer line. When connecting the column to the transfer line, you may use either the iConnect High Temperature Transfer Line Nut with the graphite Vespel™ ferrule or the regular transfer line nut

## 2 Changing the Column

Replacing the Factory Installed Column

**Note** For best results, we recommend you use the iConnect High Temperature Transfer Line Nut.

### ❖ To connect the column using the iConnect High Temperature Transfer Line Nut

**Note** If you use a graphite Vespel ferrule with your column, Thermo Fisher Scientific recommends using the iConnect High Temperature Transfer Line Nut with it. See the spare parts guide for ordering information.

1. Lower the oven temperature and allow it to cool.
2. If the TSQ 9610 system is running, shut down and vent it. See the instrument's hardware manual for instructions.



**CAUTION BURN HAZARD:** The injector, detectors, oven, and transfer line may be hot. Allow them to cool before touching them.



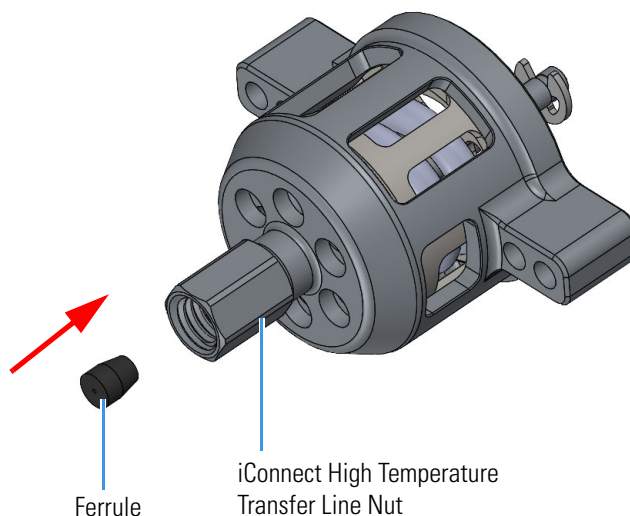
**ATTENTION RISQUE DE BRÛLURE :** l'injecteur, les détecteurs, le four et la ligne de transfert peuvent être chauds. Laissez-les refroidir avant de les toucher.

3. Unwind about one turn of the column from the column outlet end.

**Note** Wear clean, lint- and powder-free gloves when you handle the column and transfer line ferrule.

4. Wipe approximately 300 mm (12 in.) of the column with a tissue soaked in methanol.
5. Choose an appropriate ferrule for the outer diameter of your column.
6. Insert the column through the iConnect High Temperature Transfer Line Nut and ferrule, entering through the tapered end of the ferrule.
7. Wipe the column again with a tissue soaked in methanol.

**Figure 23.** iConnect High Temperature Transfer Line Nut and Graphite Vespel Ferrule Orientation



8. Insert the column into the measuring tool, which is in the MS Toolkit (See [Figure 24](#)), so that it is even with the lines at the end of the column. [Figure 25](#) indicates proper positioning of the column in the tool for accurate measuring.
9. Use a scoring wafer to score and break the column. Use a magnifying glass to check for an even, flat cut. Repeat if necessary.
10. Use a 5/16 in. wrench to hold the column measuring tool steady.

**Figure 24.** Column Measuring Tool



11. While holding the column measuring tool steady, tighten the iConnect High Temperature Transfer Line Nut with a 1/4" wrench until the column just stops moving in the ferrule.
12. Turn the iConnect High Temperature Transfer Line Nut 1 flat (60°) backward so the column is able to move in the ferrule with slight resistance.
13. Line up the outlet of the column with the arrows on the end of the column measuring tool.

## 2 Changing the Column

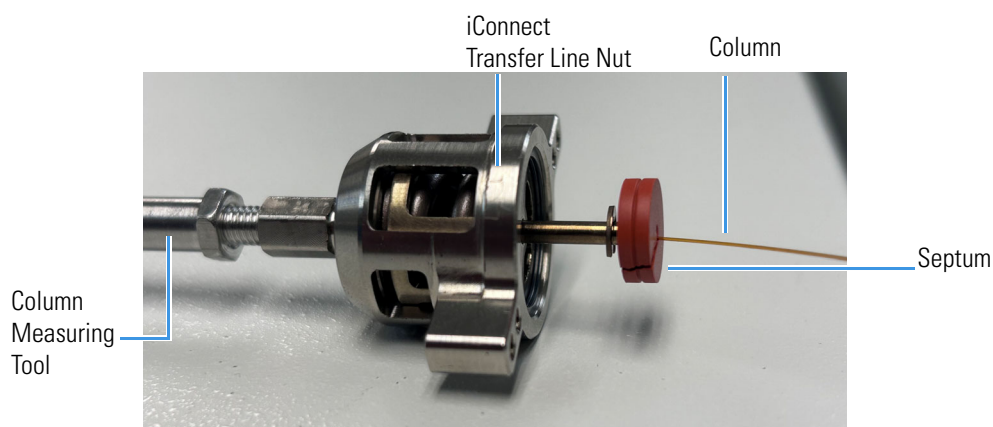
Replacing the Factory Installed Column

**Figure 25.** Lining Up the Column in the Column Measuring Tool



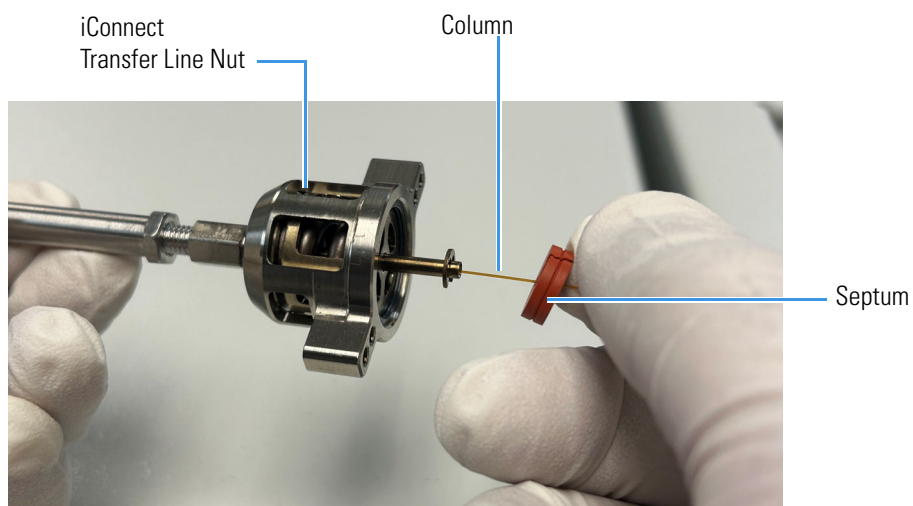
14. Place a septum with a notch cut into it behind the transfer line nut. The septum marks the place on the column where it should exit the nut.

**Figure 26.** Positioning the Septum



15. Pull the column back from the iConnect High Temperature Transfer Line Nut. Do not move the septum from its position on the column.

**Figure 27.** Pulling the Column Back from the iConnect High Temperature Transfer Line Nut



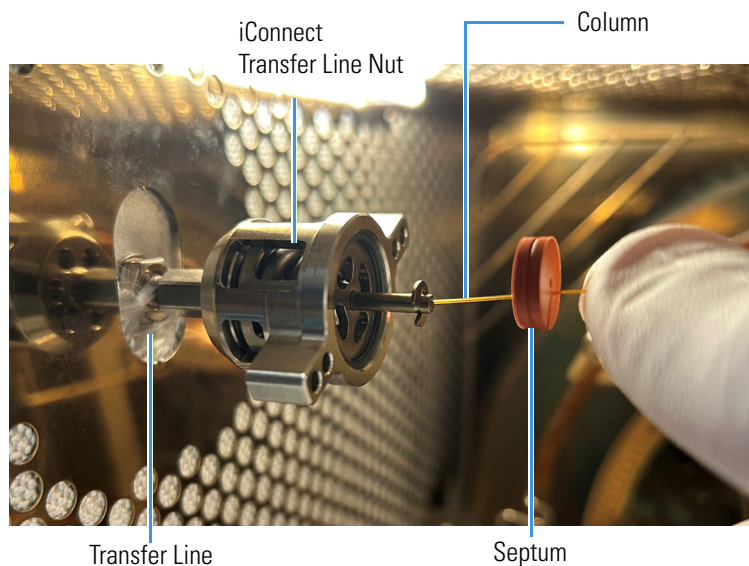


16. Loosen the transfer line nut from the column measuring tool.
17. Remove the column, transfer line nut and ferrule from the column measuring tool, making sure not to move the septum from its location on the column.

**Note** The ferrule should still be able to move on the column. Use the septum to mark the correct location where the column should exit the nut.

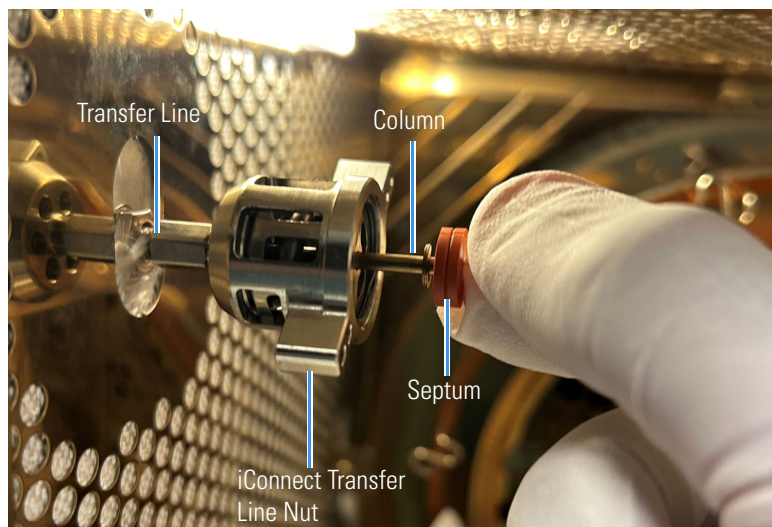
18. Insert the column into the transfer line.

**Figure 28.** Inserting the Column into the Transfer Line



19. Tighten the iConnect High Temperature Transfer Line Nut until it is just secure enough so that you cannot move it.
20. Loosen the nut by turning it exactly 1 flat (60°) backward.
21. Position the column in the transfer line using the cut septum to measure the correct length you should insert the column.

**Figure 29.** Positioning the Column in the Transfer Line



22. Tighten the iConnect High Temperature Transfer Line Nut 1 flat (60°) forward—back to where it is secure enough in the transfer line that you cannot move it.
23. Tighten the iConnect High Temperature Transfer Line Nut 1 additional quarter turn.
24. Remove the cut septum.
25. Condition the graphite Vespel ferrule:
  - a. Close the front door of the GC.
  - b. Raise the oven temperature to the maximum temperature you will operate the GC.
  - c. Wait 10 minutes.
  - d. Lower the oven temperature to 40 °C (104 °F) and allow it to cool before continuing.



**WARNING BURN HAZARD:** The oven may be hot. Allow it to cool to room temperature before opening it. The injector will still be hot, so do not touch it.



**AVERTISSEMENT RISQUE DE BRÛLURE :** le four peut être chaud. Laissez-le refroidir à la température ambiante avant de l'ouvrir. L'injecteur sera toujours chaud, donc ne le touchez pas.

26. Restore working conditions.
  - a. Raise the oven temperature to the initial temperature that you will use.
  - b. Turn on vacuum compensation on the GC.
27. Power on the TSQ 9610 instrument.

28. Once the instrument is pumped down and able to scan, view air water spectra and look for evidence of leaks with a large  $m/z$  28 signal. If you observe a leak, stop scanning and gently tighten the nut in small increments until no leaks appear when scanning.

❖ **To connect the column using the regular transfer line nut**

**Note** For best results, we recommend you use the iConnect High Temperature Transfer Line Nut. See “[To connect the column using the iConnect High Temperature Transfer Line Nut](#)” on page 24.

1. Lower the oven temperature and allow it to cool.
2. If the TSQ 9610 system is running, shut down and vent it. See the instrument’s hardware manual for instructions.



**CAUTION BURN HAZARD:** The injector, detectors, oven, and transfer line may be hot. Allow them to cool before touching them.



**ATTENTION RISQUE DE BRÛLURE :** l’injecteur, les détecteurs, le four et la ligne de transfert peuvent être chauds. Laissez-les refroidir avant de les toucher.

3. Unwind about one turn of the column from the column outlet end.

**Note** Wear clean, lint- and powder-free gloves when you handle the column and transfer line ferrule.

4. Wipe approximately 300 mm (12 in.) of the column with a tissue soaked in methanol.
5. Choose an appropriate ferrule for the outer diameter of your column.

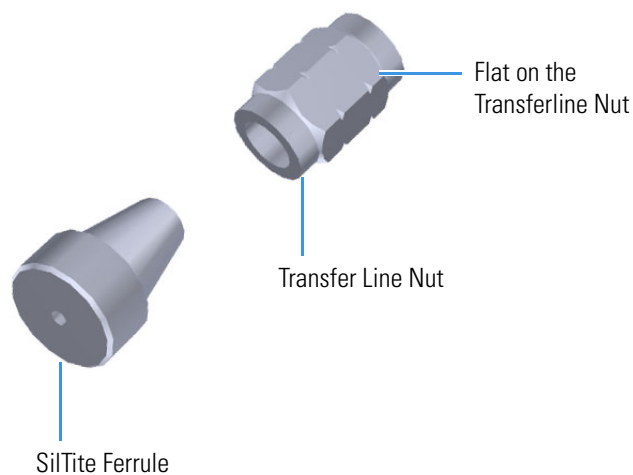
**Note** If the maximum oven temperature in your method is  $\geq 290$  °C (554 °F), Thermo Fisher Scientific recommends using a iConnect High Temperature Transfer Line Nut with a graphic Vespel ferrule or a SilTite™ nut and ferrule. By cycling the oven at and above this temperature, expansion and contraction of the graphite Vespel material can cause leaks in the transfer line.

6. Insert the column through the transfer line nut and ferrule, entering through the tapered end of the ferrule. Wipe the column again with a tissue soaked in methanol.

## 2 Changing the Column

Replacing the Factory Installed Column

**Figure 30.** Transfer Line Nut and SiLTite Ferrule Orientation



7. Insert the column into the measuring tool, which is in the MS Toolkit (See [Figure 31](#)), so that it is even with the lines at the end of the column. [Figure 32](#) indicates proper positioning of the column in the tool for accurate measuring.
8. Use a scoring wafer to score and break the column. Use a magnifying glass to check for an even, flat cut. Repeat if necessary.
9. Use a 5/16 in. wrench to hold the column measuring tool steady.

**Figure 31.** Column Measuring Tool



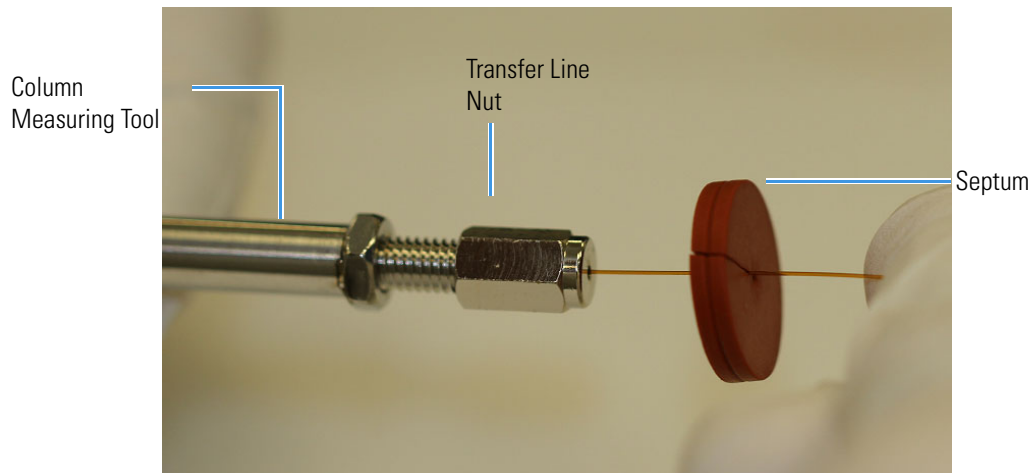
10. While holding the column measuring tool steady, tighten the transfer line nut with a 1/4" wrench until the column just stops moving in the ferrule.
11. Turn the transfer line nut 1 flat (60°) backward so the column is able to move in the ferrule with slight resistance.
12. Line up the outlet of the column with the arrows on the end of the column measuring tool.

**Figure 32.** Lining Up the Column in the Column Measuring Tool



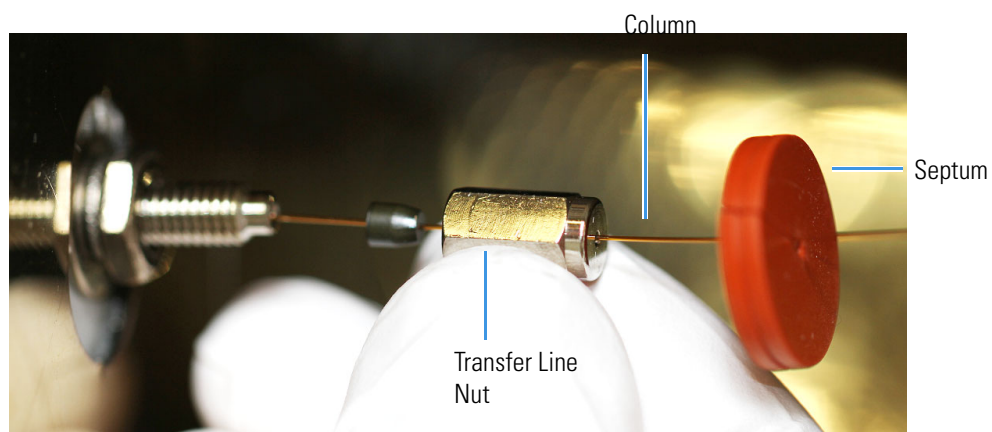
13. Place a septum with a notch cut into it behind the transfer line nut. The septum marks the place on the column where it should exit the nut.

**Figure 33.** Positioning the Septum



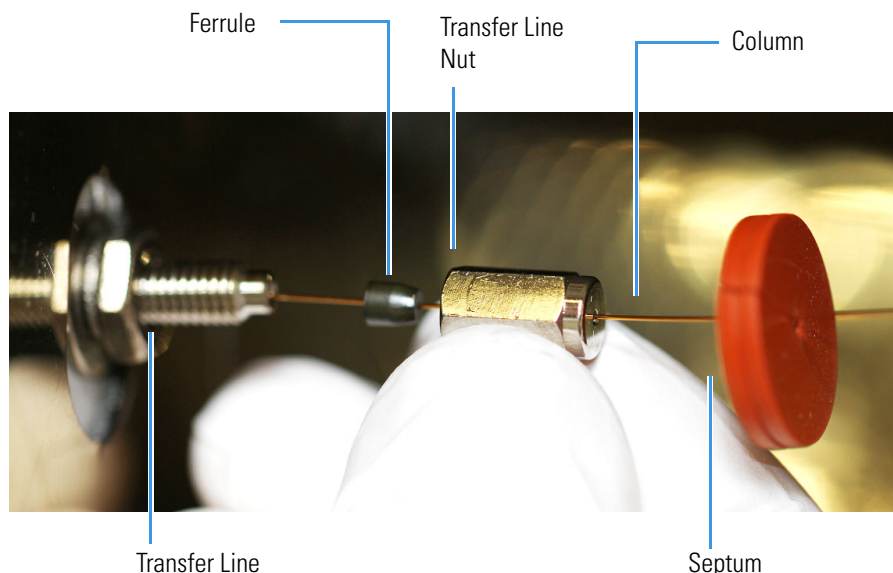
14. Pull the column back from the transfer line nut. Do not move the septum from its position on the column.

**Figure 34.** Pulling the Column Back from the Transfer Line Nut



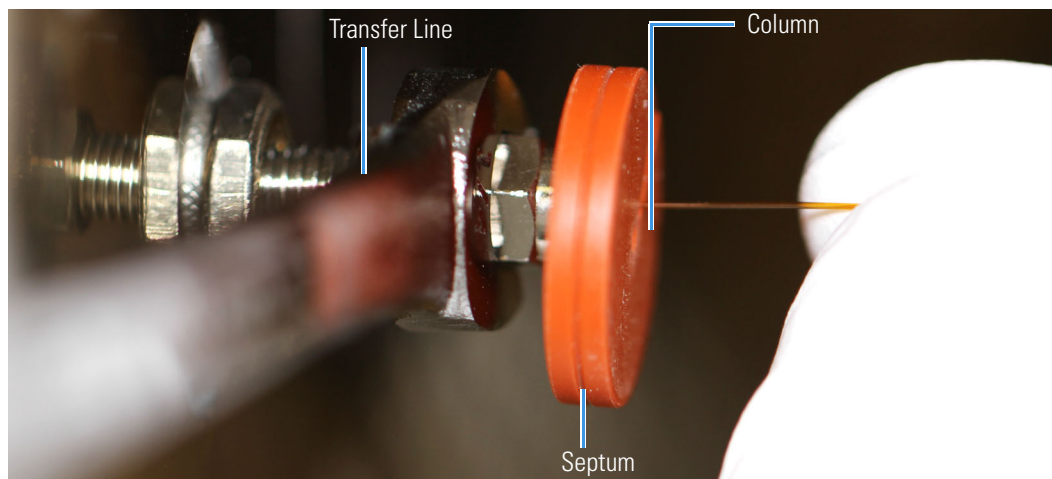
15. Loosen the transfer line nut from the column measuring tool.
16. Remove the column, transfer line nut and ferrule from the column measuring tool, making sure not to move the septum from its location on the column.
17. Insert the column into the transfer line.

**Figure 35.** Inserting the Column into the Transfer Line



18. Tighten the transfer line nut until it is just secure enough so that you cannot move it.
19. Loosen the nut by turning it exactly 1 flat (60°) backward.
20. Position the column in the transfer line. Use the septum as a guide to measure the correct length you should insert the column. Be careful not to change the location of the septum on the column.

**Figure 36.** Positioning the Column in the Transfer Line



21. Tighten the nut 1 flat (60°) forward—back to where it is secure enough in the transfer line that you cannot move it.
22. Tighten the nut 1 additional quarter turn.
23. Remove the cut septum.

**Note** If you are using a SilTite ferrule, follow the instructions that come with SilTite ferrules. If you are using a graphite Vespel ferrule, they require conditioning to ensure a leak-tight seal. See the spare parts guide for information about ordering these ferrules.

24. Condition the graphite Vespel ferrule:
  - a. Close the front door of the GC.
  - b. Raise the oven temperature to the maximum temperature you will operate the GC.
  - c. Wait 10 minutes.
  - d. Lower the oven temperature to 40 °C (104 °F) and allow it to cool before continuing.



**WARNING BURN HAZARD:** The oven may be hot. Allow it to cool to room temperature before opening it. The injector will still be hot, so do not touch it.



**AVERTISSEMENT RISQUE DE BRÛLURE :** le four peut être chaud. Laissez-le refroidir à la température ambiante avant de l'ouvrir. L'injecteur sera toujours chaud, donc ne le touchez pas.

- e. Retighten the transfer line nut.
25. Restore working conditions.
  - a. Raise the oven temperature to the initial temperature that you will use.
  - b. Turn on vacuum compensation on the GC.
  - c. Power on the TSQ 9610 instrument.

Once the TSQ 9610 instrument is pumped down and able to scan, view air water spectra and look for evidence of leaks with a large  $m/z$  28 signal. If you observe a leak, stop scanning and gently tighten the nut in small increments until no leaks appear when scanning.

## Replacing a column on a TSQ 9610 system with a VPI and an ExtractaBrite ion source or a NeverVent AEI (NVAEI) ion source

If your TSQ 9610 system has a VPI and has an ExtractaBrite ion source or a NeverVent AEI (NVAEI) ion source installed, follow the instructions below to change the column.

- ❖ **To replace the column on a TSQ 9610 system with a VPI and an ExtractaBrite or NVAEI ion source installed**
  1. Cool the oven, transfer line and ion source:
    - a. On the GC, set the Oven to Off.

## 2 Changing the Column

### Replacing the Factory Installed Column

- b. On the TSQ 9610 Dashboard set the MS transfer line temp to 40 °C and the ion source temp to 175 °C (to avoid excessive oxidation of source parts or contamination from the V-lock source plug).
2. Using the source removal tool and vacuum interlock, remove the ion source cartridge. See the *TSQ 9610 Hardware Manual* for instructions to remove the ion source cartridge.

**Note** If you have a TRACE 1610 GC, you can access videos for removing the ion source cartridge and inserting the source block on the HMI touch screen. On the touchscreen, go to Maintenance | Videos.

3. Place the ion source cartridge on the source holder and set aside.
4. Place the V-lock source plug in the source plug holder.
5. Attach the source exchange tool to the V-lock source plug in the source plug holder.
6. Twist the plug until it aligns securely in the grooves in the source exchange tool and remove the plug from the holder. The V-lock source plug is securely attached to the source exchange tool when the alignment grooves on each piece match up.

**Figure 37.** Attaching the V-lock Source Plug to the Source Exchange Tool



**Note** Use compressed air to blow all the dust off the V-lock source plug before inserting it into the mass spectrometer.

7. Once the ion source temperature has dropped below 200 °C, insert the barrel end of the source exchange tool into the vacuum interlock and twist it clockwise to lock the source exchange tool into position. Be sure the black handle remains fully extended and locked.

**Note** If the ion source temperature is above 200 °C, parts of the ion source or the V-lock source plug could oxide and be damaged, causing leaks in the MS system.

8. Evacuate the VPI.
  - a. Confirm that the source removal tool is properly engaged in the VPI.
  - b. Press the blue **Evacuate** button on the front of the instrument.

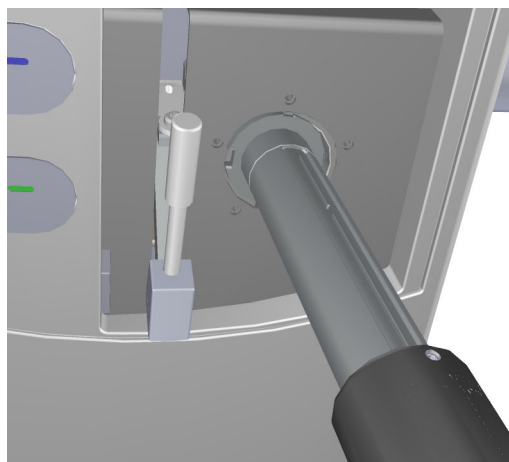


- c. The **Evacuate** light will begin to flash green, and should continue to flash green for approximately 20 seconds.
9. If the pressure has returned to an acceptable value after the 20-30 second wait, the evacuate light will turn off and the **Ready to Open** light will be solid green. At that point, the air has been evacuated from the instrument and it is safe to open the vacuum interlock valve.

**Note** If the vacuum light flashes amber, there is a leak in the system.

10. Pull the vacuum interlock handle up when the **Ready to Open** light is a solid green.
11. Twist the handle of the tool slightly to the left until it is lodged into the left-most track. See [Figure 38](#).

**Figure 38.** Inserting the V-lock Source Plug



12. Push the handle toward the instrument until the end of the handle aligns with the engraved line at the end of the barrel. When you reach this line, the tool is all the way in and the V-lock source plug is securely placed in the instrument. See [Figure 39](#).

**IMPORTANT** The V-lock source plug should remain attached to the source exchange tool. Do not rotate the source exchange tool handle to attempt to disengage the source plug.

## 2 Changing the Column

### Replacing the Factory Installed Column

**Figure 39.** V-lock Source Plug Inserted Correctly



13. Wait for oven and transfer line temperatures to drop below 50 °C to avoid burns before proceeding to touch the column and nut.

**IMPORTANT** Monitor the foreline pressure when removing the column and nut to confirm that the V-lock source plug is properly sealing the transfer line. If the pressure exceeds 1 Torr, the leak is excessive, and the source plug should be reseated or inspected for damage, especially the white o-ring on the end of the source plug. If the turbomolecular pump is forced off by the vacuum protection, the power might need to be reset to start the pumps.

14. Follow the steps here to remove the column in the instructions for replacing the column below. Remove the current column from the MS transfer line. To install the column in the GC inlet, follow the instructions in [“Installing the Column in the GC Inlet”](#) on [page 39](#).

**IMPORTANT** If a column will not be immediately added to the transfer line (such as when column conditioning or other GC maintenance is to be performed), then blank off the transfer line with a transfer line nut with a no-hole graphite Vespel ferrule. Once the transfer line is blanked off, the V-lock source plug can be removed until a column is ready to be installed into the transfer line.

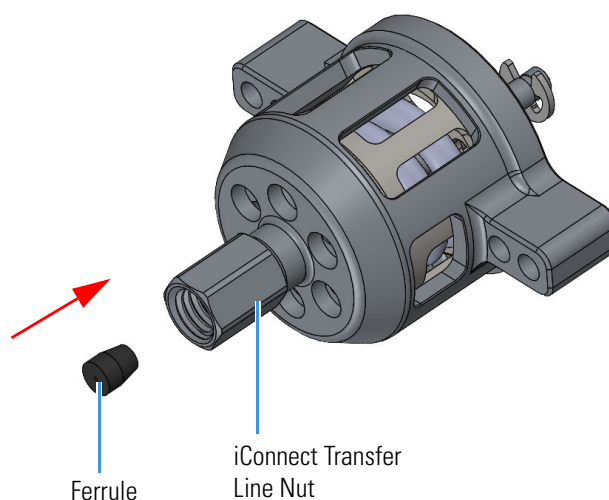
15. Unwind an appropriate column length to insert into the transfer line along the front of the instrument. Leaving about an inch gap between the column and the left side of the front panel will usually give you an appropriate length of column for installation.

**Note** Wear clean, lint- and powder-free gloves when you handle the column and transfer line ferrule.

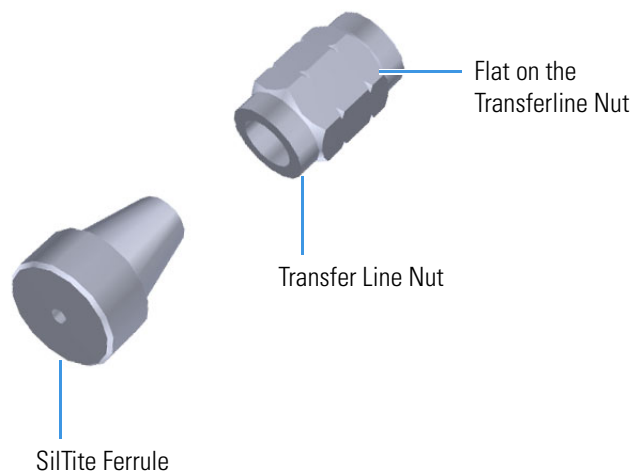
16. Wipe approximately 300 mm (12 in.) of the column with a tissue soaked in methanol.
17. Choose an appropriate ferrule for the outer diameter of your column.

18. Insert the column through the iConnect High Temperature Transfer Line Nut and ferrule, entering through the tapered end of the ferrule.
19. Wipe the column again with a tissue soaked in methanol.

**Figure 40.** iConnect High Temperature Transfer Line Nut and Graphite Vespel Ferrule Orientation



**Figure 41.** Transfer Line Nut and SiLTite Ferrule Orientation



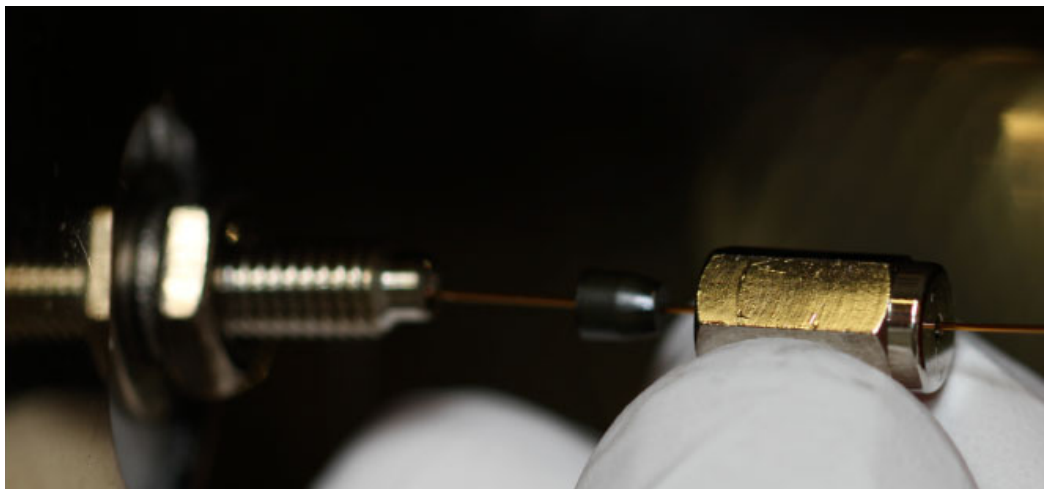
20. Insert the new column through the MS transfer line.
21. Carefully extend the column out the front to allow application of the nut and ferrule.
22. Insert the column through the nut and ferrule (flat side of the nut faces the MS).
23. Use a scoring wafer to score and then remove the last 10 mm of column to provide a clean, well-cut end.
24. Wipe the column with an alcohol soaked-wipe after inserting through the ferrule.

## 2 Changing the Column

### Replacing the Factory Installed Column

25. Carefully push the column back into the GC transfer line while keeping the nut and ferrule on the column.
26. Insert the column into the MS transfer line and tighten the nut until the column just resists sliding through the ferrule.

**Figure 42.** Installing the Column into the MS Transfer Line



27. Loosen the nut  $\frac{1}{4}$  turn and gently push the column into the MS transfer line until it just touches the V-lock source plug.
28. Pull the column  $\frac{1}{2}$  to 1 mm away from the V-lock source plug and tighten the nut  $\frac{1}{2}$  turn.

**Note** To avoid forcing the column into the V-lock source plug when tightening the nut, the column should be pulled back approximately 1 mm before tightening the nut.

29. Ensure the column and nut are correctly installed in the MS transfer line.
30. Remove the V-lock source plug with the insertion/removal tool.
31. Lower the handle to close the vacuum interlock.
32. Remove the source exchange tool.
33. Allow the V-lock source plug to cool.
34. Carefully remove the V-lock source plug from the insertion/removal tool using the source plug holder.

**Tip** To avoid collecting dust on the V-lock source plug, store it in a closed container when not in use.

35. Using the source holder, place the ion source on the insertion/removal tool and install the ion source using the vacuum interlock.

Once the TSQ 9610 instrument is pumped down and able to scan, view air water spectra and look for evidence of leaks with a large  $m/z$  28 signal. If you observe a leak, stop scanning and gently tighten the nut in small increments until no leaks appear when scanning.

## Installing the Column in the GC Inlet

1. Remove the current column as described in “Replacing a column in a TSQ 9610 system with no VPI or an Standard AEI ion source” on page 23 or “Replacing a column on a TSQ 9610 system with a VPI and an ExtractaBrite ion source or a NeverVent AEI (NVAEI) ion source” on page 33 depending on your MS and ion source type..



**WARNING BURN HAZARD:** The injector, oven, and transfer line may be hot. Allow them to cool to room temperature before touching them.



**AVERTISSEMENT RISQUE DE BRÛLURE :** l'injecteur, le four et la ligne de transfert peuvent être chauds. Laissez-les refroidir à la température ambiante avant de les toucher.

2. Connect the new column to the injector inside the GC.

**Note** Wear clean, lint- and powder-free gloves when you handle the column and injector ferrule.

- a. Unwind the column enough to easily connect its ends to the injector and detector.
- b. Wipe about 100 mm (4 in.) of the column with a tissue soaked in methanol.
- c. Insert the column through the injector retaining nut and ferrule (larger end up). If the M4 retaining nut is used, slide it on the column through the side cut. Wipe the column again with a tissue soaked in methanol.

**Tip** Slide a notched septum on the column before the injector retaining nut to make it easier to measure the proper distance between the nut and end of the column.

- d. Use a scoring wafer to score and break the column about 1 cm (0.4 in.) from the end. Use a magnifying glass to check for an even, flat cut. Repeat if necessary.
- e. Insert a notched septum on the column to hold the retaining nut at this position. Thread the retaining nut into the injector but do not tighten.
- f. Ensure that the end of the column is the proper distance (splitless = 5 mm, split = 10 mm, PTV and PTVBKF = 30 mm) from the back of the injector nut.
- g. Adjust the column position so that the septum contacts the bottom of the retaining nut. Use your fingers to tighten the retaining nut until it starts to grip the column.
- h. Tighten the column nut finger-tight until it starts to grip the column plus a quarter turn.

## 2 Changing the Column

### Replacing the Factory Installed Column

- i. Remove the notched septum from the column.
3. Set up the GC parameters:
  - a. Set the oven and injector temperature to 50 °C (122 °F).
  - b. Set the carrier gas flow to 1.0 mL/min.
  - c. Turn off vacuum compensation, which is located on the Carrier menu of the GC.
  - d. Use the column flowmeter connector to verify that there is flow through the column. If you do not have a flowmeter, dip the column outlet in a small vial of methanol. Bubbles indicate there is flow through the column. If there is no flow, check that the carrier gas is on, the GC inlet is pressurized, and the column is not plugged. If there is still no flow, consult the GC documentation or contact Technical Support.
  - e. Allow the column to purge for at least 10 minutes. If you used methanol to detect column flow, remove column from methanol during purge time.
  - f. Insert the column into the fitting of the column flowmeter connector that blocks the column flow.

4. Perform a column leak check:

- a. On the TRACE 1310, select the **Leak Check** icon in the **Maintenance** menu. Otherwise, perform the leak check through the Chromatography Data System. Refer to the *TRACE 1600 and TRACE 1610 Series GC User Guide* for instructions.
- b. Start the leak check.

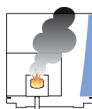
The split and purge valves of the selected channel are automatically closed, and the channel is pressurized with carrier gas to the leak check setpoint.

The system monitors the pressure for one minute. If the pressure does not drop more than the maximum allowed sensitivity value, then the leak check will pass. If the leak check does not pass, use the leak detector to find and fix any leaks.

**Tip** Leaks can be caused by not tightening the fitting on the column flowmeter connector. Check the fitting before looking for the leak elsewhere.



**CAUTION INSTRUMENT DAMAGE:** Do not allow the column flowmeter connector to exceed 80 °C (176 °F). Otherwise, it will melt and damage the instrument.

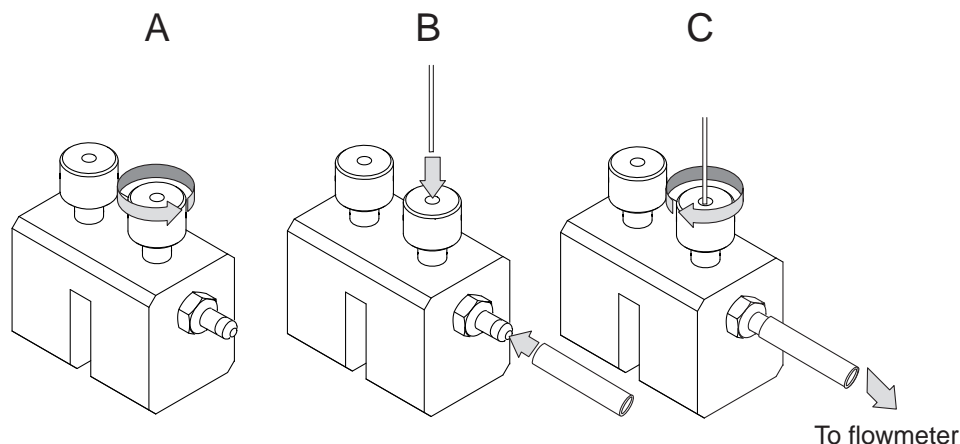


**ATTENTION DOMMAGES À L'INSTRUMENT :** ne laissez pas le connecteur du débitmètre de la colonne dépasser les 80 °C (176 °F). Dans le cas contraire, il va fondre et endommager l'instrument.

- c. Repeat the leak check until no leaks are indicated.
5. Calibrate the carrier gas flow (column evaluation):

- a. Carefully push the capillary column end into the flowmeter section of the column flowmeter connector.

**Figure 43.** Column Flowmeter Connector



- b. Connect the flowmeter to the dedicated fitting on the column flowmeter connector.
- c. If you have a TRACE 1310, select the **Back** or **Front Column** icon in the **Configuration** menu. Otherwise, perform the column evaluation through the Chromatography Data System. See the *TRACE 1600 and TRACE 1610 User Guide* for instructions.
- d. Select **Column** and input the column's physical characteristics.
- e. If a pre-/post column is present, set the length and nominal internal diameter of the pre-/post column in the same valid ranges for the column. The following two lines are added to the menu.

**Note** For the most reproducible results, you should conduct a more detailed column evaluation. However, the following steps, while recommended, are not required.

- f. Start the column evaluation. According to the physical characteristics of the column, the system calculates and displays the relevant column K-factor. At the end of the routine, a message will indicate that the evaluation was successful.
- g. Expect a K-factor of approximately 0.7 – 0.9 for a 15 m, 0.25 mm i.d. column (1.3 – 2.0 for a 30 m, 0.25 mm i.d. column). If the column does not report a K-factor within this range or within 0.1 units of the previous stored value, check for a leak or broken column using the leak detector. The K-factor is a measured resistance for the column. A K-factor that is too low may indicate a leak in the system, while a K-factor that is too high may indicate a blockage.

Fix any issues found and rerun column evaluation until an appropriate K-factor is achieved. e a leak in the system, while a K-factor that is too high might indicate a blockage.

6. Disconnect the column flowmeter:

## 2 Changing the Column

### Replacing the Factory Installed Column

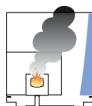
- a. Disconnect the column from the column flowmeter connector.
  - b. Remove the clear plastic component, including its fittings, from the oven and set them aside.
  - c. Close the GC door.
7. If necessary, condition the column before inserting it into the TSQ 9610 system. Column conditioning consists of passing a carrier gas flow through the column heated to a programmed temperature as described in the column manufacturer's instructions.

**IMPORTANT** Do not leave the source plug in the instrument for an extended amount of time. Add a no-hole ferrule to the column during conditioning. Then remove the source plug from the instrument. (You do not have to reinstall the ion source cartridge.) Reinstall the source plug into the VPI before removing the no-hole ferrule.

- a. If there are no conditioning instructions, perform the column conditioning by setting a final temperature 10 °C–20 °C below the column's recommended maximum temperature.



**CAUTION INSTRUMENT DAMAGE:** The material released from the column (column bleed) during conditioning may contaminate the ion source if the column is inserted into the transfer line during the high-temperature stage of conditioning.



**ATTENTION DOMMAGES À L'INSTRUMENT :** les matières rejetées par la colonne (ressuage de la colonne) lors du conditionnement peuvent contaminer la source d'ions si la colonne est insérée dans la ligne de transfert lors de la phase à haute température du conditionnement.



**WARNING FIRE HAZARD:** Do not use hydrogen as the carrier gas for conditioning your column. It could vent into the oven and present an explosion hazard.



**AVERTISSEMENT RISQUE D'INCENDIE :** n'utilisez pas d'hydrogène comme gaz vecteur pour le conditionnement de votre colonne. Il pourrait être ventilé à l'intérieur du four et présenter un risque d'explosion.

- b. Run the slow temperature program that is recommended by the manufacturer. A typical program would hold the column at 40 °C (104 °F) for 15 minutes, and then ramp at 10 °C/min (50 °F/min) up to 10–20 °C below the maximum allowed column temperature. Hold the column at this temperature for two hours.



**CAUTION INSTRUMENT DAMAGE:** Never exceed the column manufacturer's maximum operating temperature.





**ATTENTION DOMMAGES À L'INSTRUMENT** : ne dépassez jamais la température de fonctionnement maximum de la colonne indiquée par le fabricant.



# Tuning

Tuning will improve the performance of your TSQ 9610 system. For optimum stability, you must wait until the power, vacuum, and heaters lights on the front of the instrument are a solid green. These lights indicate that the instrument has reached vacuum and that it is at the last set temperature. If the system has been powered off for a period of time (that is, a cold system), the system components take up to 4 hours to thermally stabilize after reaching the temperature setpoint. If you did not vent the instrument (that is, the system is hot), the components take approximately 10 minutes to thermally stabilize after reaching the temperature setpoint. If you exchanged the ion source without venting, the source components take approximately 30 minutes to stabilize temperature.

## Contents

- [Accessing AutoTune](#)
- [Tune Types](#)
- [Tuning the Mass Spectrometer](#)

You can tune the TSQ 9610 system by using the TSQ Series Dashboard or the AutoTune in Chromeleon.

**IMPORTANT** Be sure to give the TSQ 9610 system enough time to stabilize. Otherwise, you may see mass drift, mass spectral changes, or changes in the fragmentation of your data.

**Note** If you are running samples with heavy matrix, running the samples before the source has had time to stabilize at high temperature will prematurely dirty the ion volume and optics.

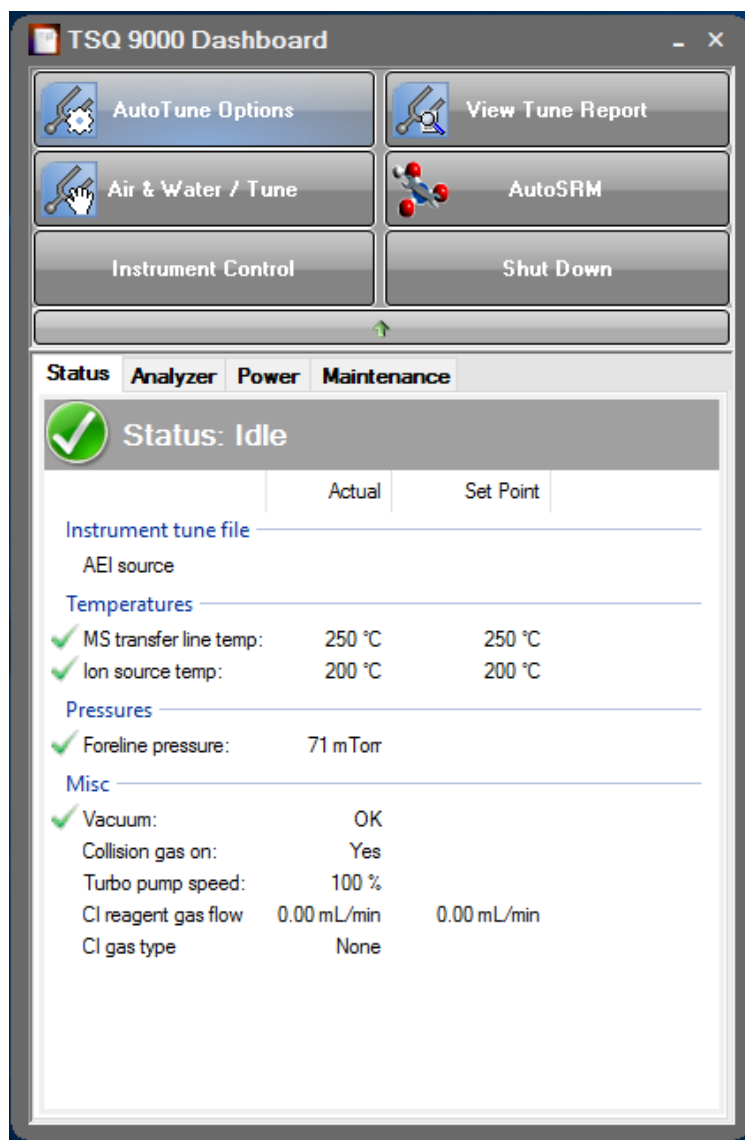
**Tip** For the simplest recommended tuning for the TSQ 9610 system, see [“To use the SmartTune application in Xcalibur software” on page 61](#) or [“To use the SmartTune application in Chromeleon Software” on page 66](#).

## Accessing AutoTune

### ❖ To access AutoTune in Xcalibur Software

1. Double-click the **TSQ Series Dashboard** shortcut on your desktop to open the TSQ Series Dashboard and then click **AutoTune Options**. See [Figure 44](#).

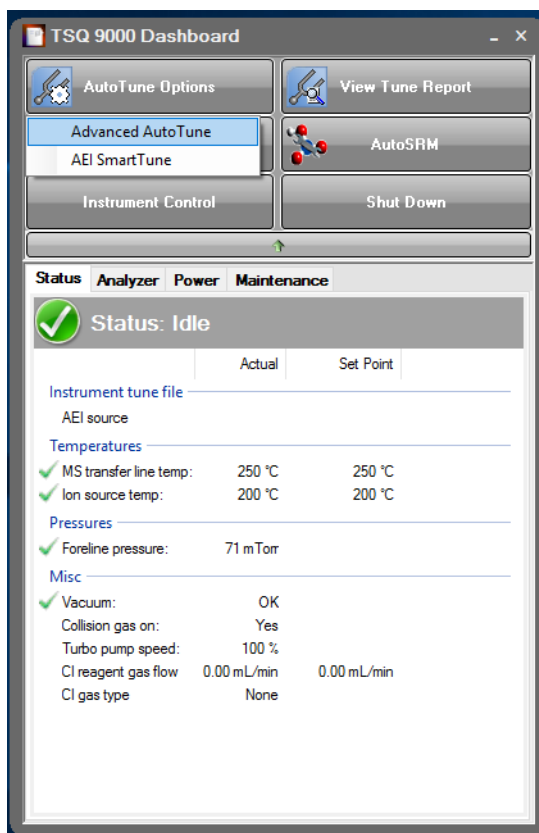
**Figure 44.** TSQ Series Dashboard



**Note** AutoTune button options can be configured in instrument configuration in the SmartTune tab. If only one link to AutoTune is configured, the button will be labeled with that tuning option (for example, AutoTune or EI SmartTune) and there will not be another selection when selecting the button. If you do not see the tuning option you want to use in the dashboard, please close any instrument applications and configure your instrument.

- If you have configured Advanced AutoTune or SmartTune for your EI or AEI ion source you may access those options by right-clicking on **AutoTune Options** and choosing from a drop-down menu. See [Figure 45](#).
- 

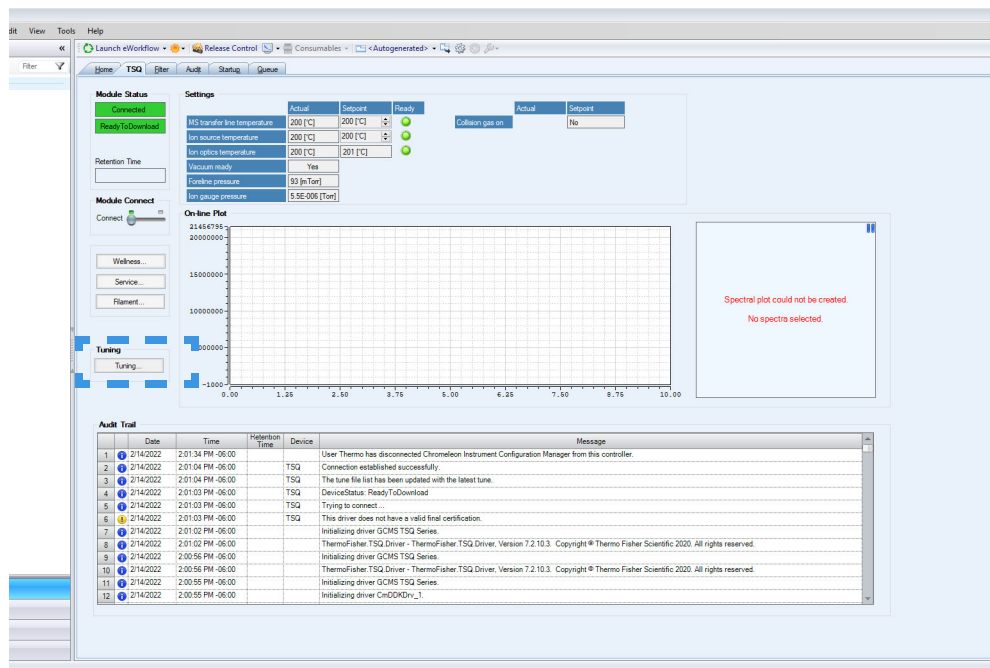
**Figure 45.** Selecting from AutoTune Options



❖ **To access TSQ 9610 Tuning in Chromeleon Software**

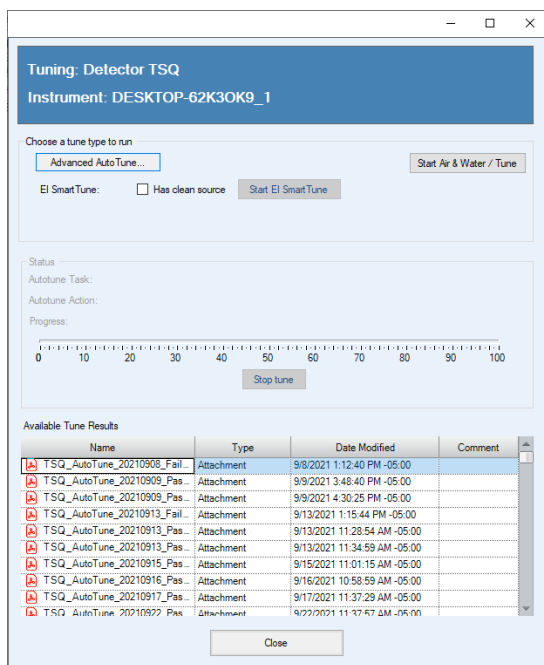
- Go to the **TSQ** tab on the Chromeleon Console and click **Tuning** to open the tuning window. See [Figure 46](#).

Figure 46. Accessing TSQ 9610 Tuning from the Chromeleon Console



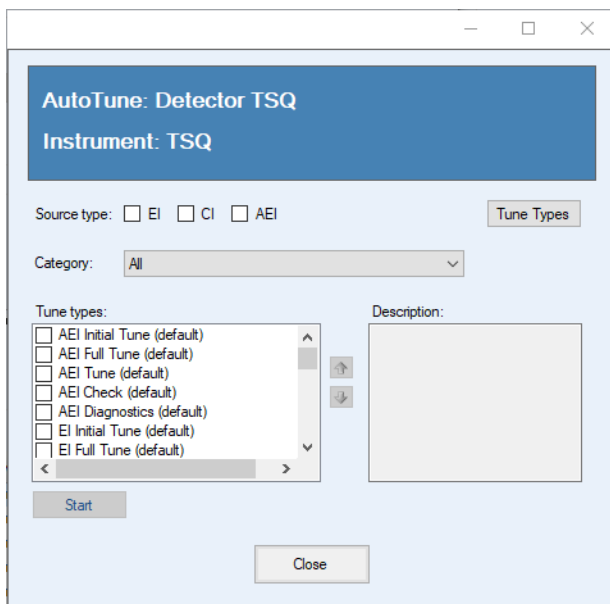
- If you have configured Advanced AutoTune or SmartTune for your EI or AEI ion source you may access those options in the by clicking **Advanced AutoTune** in the Tuning utility. See Figure 47.

Figure 47. Opening the Tuning Panel



- The AutoTune window with a list of available tune types opens. See Figure 48.

Figure 48. Opening the AutoTune Window



## Tune Types

This section describes the available tune types for the mass spectrometer.

- AEI Initial Tune
- AEI Full Tune
- AEI Tune
- AEI Check
- AEI Diagnostics
- Negative CI Tune
- Positive CI Tune
- AEI Full Tune
- AEI Tune
- AEI Check
- AEI Diagnostics

## EI Initial Tune

**EI Initial Tune (default)**—This tune is used to reset parameters that could be used as a starting point for all the other tunes after cleaning the ion source. As a result, use this tune only when the ion source is clean. This tune should also be used when changing from a legacy tune file generated with earlier instrument control software. The EI Initial tune starts with the tune file stored in the instrument at the factory, which must have correct frequency set points and close mass calibration for this tune to pass. During the tune, detector gain is calibrated to generate approximately 300,000 electrons for each ion that strikes the detector. The tune then performs a resolution and mass calibration, tunes the lenses and performs a leak check. The quadrupole offset and repeller voltages are set to low values to easily tune resolution, but may make this tune less sensitive than other tunes that maximize these voltages. Additionally, this tune generates spectra that are the closest in appearance to the factory tune and can be used by your service engineer to create a new factory tune file on the instrument.

**Note** If components of the mass analyzer have changed and the factory tune file no longer has the correct frequency or mass calibration, the factory file may be updated in TSQ 9610 Manual Tune, which you can access by selecting **Air & Water / Tune** on the TSQ 9610 Dashboard. The factory tune file may be loaded or saved by pressing the **Alt** key while selecting **Get from Instrument** or **Save to Instrument**. Please contact [www.unitylabservices.com/en/home.html](http://www.unitylabservices.com/en/home.html) for more details.

## EI Full Tune

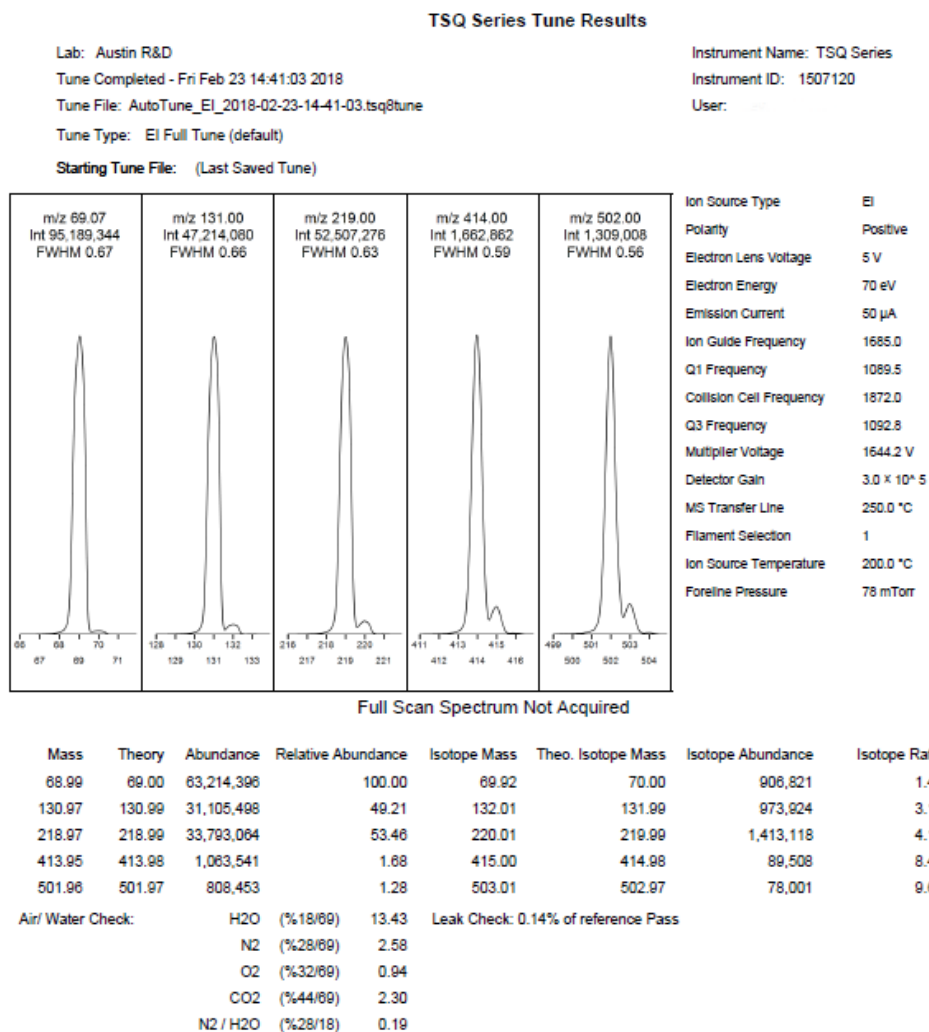
**EI Full Tune (default)**—This tune is used to completely retune the system. It takes the longest amount of time to run, but the advantage of using it is that it re-optimizes nearly all the parameters affecting the signal. This type of tune will perform a mass calibration, tune the lenses and resolution, and perform a leak check. The detector gain will be calibrated to generate 300,000 electrons for every ion that strikes the detector. You should run an EI full tune when the tune check is not adequate, when the electron multiplier is getting old (tuning to high electron multiplier voltages), or the first tune after you replace the electron multiplier. Unless your SOP requires it, this is not the best tune to use on a daily basis because of the length of time it takes to run it

Figure 49 shows a typical tune report for an EI Full Tune on a system using helium as a carrier gas.

**Note** A new detector or a detector that has been exposed to the atmosphere by venting the instrument should be conditioned for several minutes by scanning with the filament on until the signal stabilizes before running a tune of the detector gain.



Figure 49. Typical EI Full Tune Report



Typical results for an EI Full Tune are listed below.

- Peak Intensities:
  - Base Peak is  $m/z$  69 or 219
  - Base Peak  $\sim$  20,000,000
- Water Background:  $m/z$  18:69 < 240%
- Repeller Voltage:
  - Helium carrier gas = 3–8 V
  - Hydrogen carrier gas = 7–15 V
- Foreline Pressure: < 100 mTorr

- Ion Gauge Pressure:  $<5 \times 10^{-5}$  Torr

**Note** Foreline and ion gauge pressures are dependent on column flow rate.

- Leak Check: < 10%

Run the EI Full Tune if you suspect a system problem. The following conditions could indicate an issue:

- Increased detector gain—Detector gain is related to multiplier voltage, so if the detector gain is increased, multiplier voltage will also increase.
- Leak check change—Leak check results change over time base on instrument conditions. Recently vented systems exposed to air should be lower than 10% after one day of pumping down. Assuming the system is leak free, the instrument leak check should constantly decrease over time until stabilizing.

## EI Tune

**EI Tune (default)**—A shortened version of the EI Full Tune recommended for use when subsequent maintenance tuning is needed after an EI Full Tune. This tunes resolution, mass, lenses, and adjusts detector sensitivity, but does not tune detector gain. It requires a starting tune file saved to the instrument to give masses within 0.5 amu and widths less than 1 FWHM. It starts with the last saved tune and sets the detector sensitivity to generate an ion at  $m/z$  219 with an intensity of 20,000,000<sup>1</sup> counts.

## EI Check

**EI Check (default)**—Used to check how well your last tune is performing. The EI Check performs a leak check, makes sure the mass calibration is correct (that mass error is within 0.2 amu) and generates a report. If your SOP allows it, you can use this tune to rapidly verify that the previous tune is still generating good spectra.

## EI Diagnostics

**EI Diagnostics (default)**—Runs a complete set of diagnostics, including a leak check, and generates a report. No tuning is performed. Uses the parameters from the last saved tune.

---

<sup>1</sup> This number is different when this tune type is run in EI SmartTune.

## Negative CI Tune

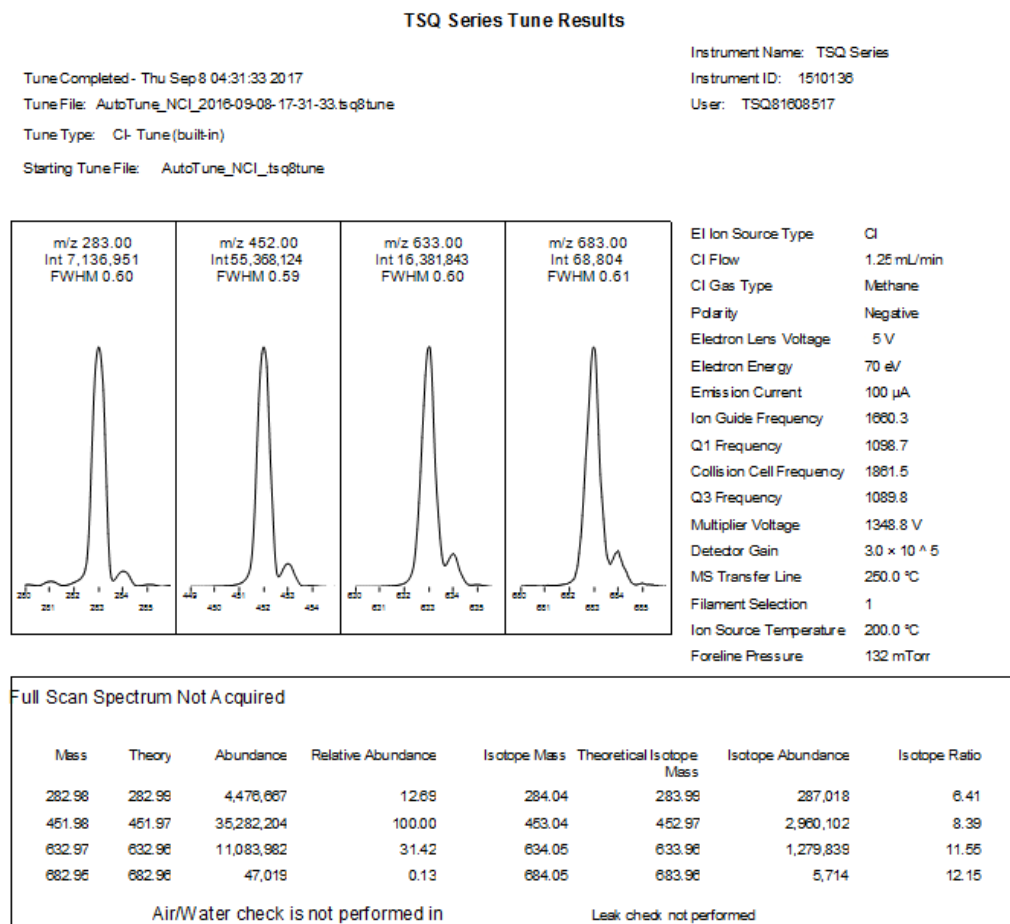
**CI- Tune**—Used to analyze samples with negative CI. The standard NCI tune performs a mass calibration, then tunes the lenses and sets the resolution. This type of tune assumes you are using methane as the CI reagent gas and tunes the system with a 1.25 mL/min flow. This tune does not set the detector gain. The built-in CI- tune will start with the most recent AutoTune\_NCI tune file, so have an appropriate tune file saved on the instrument's PC.

**Note** Chemical ionization tunes are very different from the electron ionization tunes. Do not use a CI tune unless your instrument has a CI ion volume and CI reagent gas installed.

**Note** If the instrument was last used in EI mode and tuned with a high repeller voltage before switching to a clean CI ion Source, a tune file with a low repeller voltage (*i.e.*—0.5 V) should be loaded in manual tune and saved to the instrument before tuning in CI mode.

Figure 50 shows a typical CI- Tune report where methane is the CI reagent gas.

**Figure 50.** Typical CI- Tune Report with Methane as a CI Reagent Gas



Typical results for a CI- Tune using methane as the reagent gas are listed below.

- Peak Intensities:
  - Base Peak: 452 or 633
  - Base Peak  $\geq 6,000,000$
- CI Gas Flow: 1.0–4.0 mL/min Methane
- Emission Current: 50–100  $\mu\text{A}$

**Note** Emission current may be set in the instrument method, and the value entered in the method should match the value set in the tune.

- Multiplier Voltage
  - Normal Performance:  $< 2200\text{ V}$
  - Replace Multiplier:  $\geq 2200\text{ V}$
- Foreline Pressure:  $< 400\text{ mTorr}$
- Ion Gauge Pressure:  $< 1 \times 10^{-5}\text{ Torr}$

**Note** Foreline pressure fluctuates with CI reagent gas flow rate. As the CI reagent gas flow rate increases, the foreline pressure also increases. Ion gauge pressure also increases if an ion gauge is installed on the system.

- Isotope Ratios:
  - $m/z\ 453:452 = 5.8\text{--}11.8\%$

**Tip** If the reagent gas flow fluctuates, confirm the supply pressure is  $< 35\text{ psi}$ . Due to inaccuracy and poor precision of some gas regulators, lower supply pressure (10–15 psi) is recommended.

## Positive CI Tune

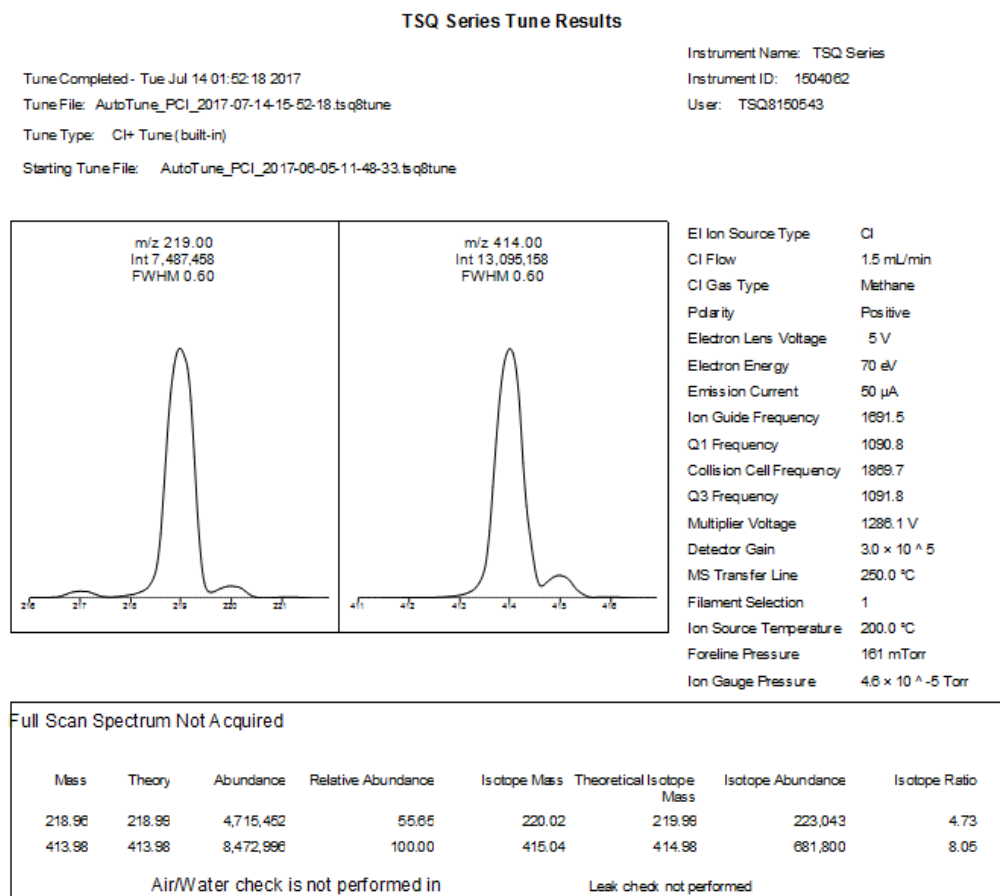
**CI+ Tune**—Used to analyze samples with positive CI. The standard PCI tune performs a mass calibration, then tunes the lenses and sets the resolution. This type of tune assumes you are using methane as the CI reagent gas and tunes the system with a 1.5 mL/min flow. This tune does not set the detector gain. The built-in CI+ tune will start with the most recent AutoTune\_PCI tune file, so have an appropriate tune file saved on the instrument's PC.

**Note** Chemical ionization tunes are very different from the electron ionization tunes. Do not use a CI tune unless your instrument has a CI ion volume and CI reagent gas installed.

**Note** If the instrument was last used in EI mode and tuned with a high repeller voltage before switching to a clean CI ion Source, a tune file with a low repeller voltage should be loaded in manual tune and saved to the instrument before tuning in CI mode.

Figure 51 shows a typical CI+ Tune report where methane is the CI reagent gas.

**Figure 51.** Typical CI+ Tune Report with Methane as a CI Reagent Gas



**Tip** If you intend to use ammonia reagent gas, attach methane to one CI reagent gas port and ammonia to the other port. Tune the instrument using methane, then switch to the ammonia port. Allow plenty of time for the new reagent gas to purge the CI tubing before starting your analysis. Please note that the instrument is locked for approximately two minutes to evacuate the volume between gas valves when switching between gases. During this time the instrument will not respond to new commands. This is normal behavior.

Typical results for a CI+ Tune using methane as the reagent gas are listed below.

- Peak Intensities:
  - Base Peak: 414
  - Base Peak  $\geq 1,000,000$
- CI Gas Flow: 1.5–4.0 mL/min Methane

- Emission Current: 25–50  $\mu\text{A}$

**Note** Emission current is an input value, and it should match the value set in the tune.

- Multiplier Voltage
  - Normal Performance: < 2200 V at  $3 \times 10^5$  detector gain
  - Replace Multiplier:  $\geq 2500$  V at  $2.1 \times 10^6$  detector gain
- Foreline Pressure: < 400 mTorr
- Ion Gauge Pressure: <  $1e-4$  Torr

**Note** Foreline pressure fluctuates with CI reagent gas flow rate. As the CI reagent gas flow rate increases, the foreline pressure also increases. Ion gauge pressure also increases if an ion gauge is installed on the system.

- Isotope Ratios:
  - $m/z$  415:414 = 5.8–11.8%

**Note** To add a tune type to the list, see [Modifying an Automatic Tune](#).

## AEI Full Tune

**AEI Full Tune (default)**—(To be used only with the AEI or NeverVent AEI ion sources.) Provides full AEI tuning and is used to completely retune the system. It takes the longest amount of time to run, but it has the advantage of reoptimizing nearly all the parameters affecting the signal. It runs and sets detector gain to  $3 \times 10^5$ . It requires a starting tune file saved to the instrument that gives masses within 0.5 amu and widths less than 1 FWHM. This type of tune performs a mass calibration, tunes the lenses and resolution, and performs a leak check. Unless your SOP requires it, this is not the best tune to use on a daily basis because of the length of time required to run it.

## AEI Tune

**AEI Tune (default)**—(To be used only with the AEI or NeverVent AEI ion sources.) A shortened version of the AEI Full Tune recommended for use when subsequent maintenance tuning is needed after an AEI Full Tune. This tunes resolution, mass, lenses, and adjusts detector sensitivity, but does not tune detector gain. It requires a starting tune file for the AEI ion source saved to the instrument that gives masses within 0.5 amu and widths less than 1 FWHM. It starts with the last saved tune and sets the detector sensitivity to generate an ion at  $m/z$  219 with an intensity of 200,000,000<sup>2</sup> counts.

---

<sup>2</sup> This number may be modified when using AEI SmartTune.

## AEI Check

**AEI Check (default)**—(To be used only with the AEI or NeverVent AEI ion sources.) Used to check how well your last tune is performing. The AEI check performs a leak check, makes sure the mass calibration is correct (that mass error is within 0.2 amu), and generates a report. If your SOP allows it, you can use this tune to rapidly verify that the previous tune is still generating good spectra.

## AEI Diagnostics

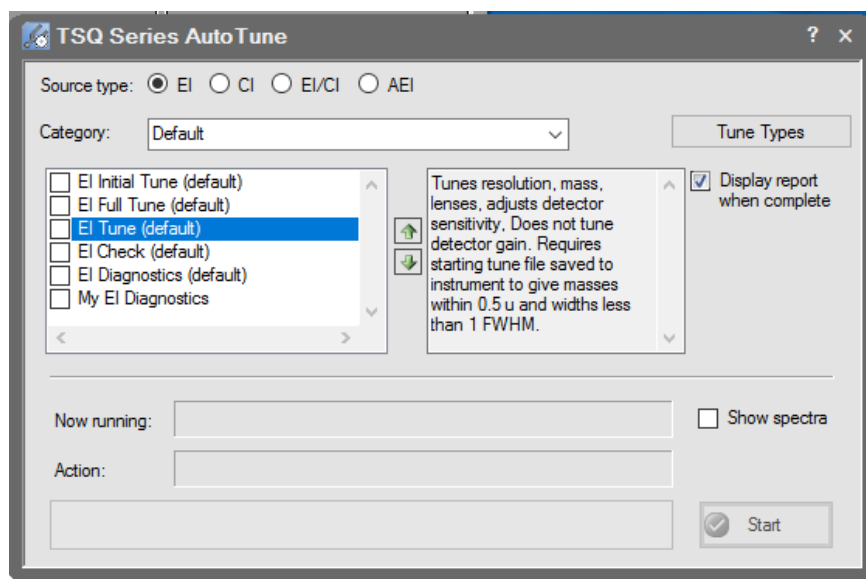
**AEI Diagnostics (default)**—(To be used only with the AEI or NeverVent AEI ion sources.) Runs a complete set of diagnostics, including a leak check, and generates a report. No tuning is performed. Uses the parameters from the last saved tune.

## Tuning the Mass Spectrometer

### ❖ To tune your mass spectrometer in Xcalibur

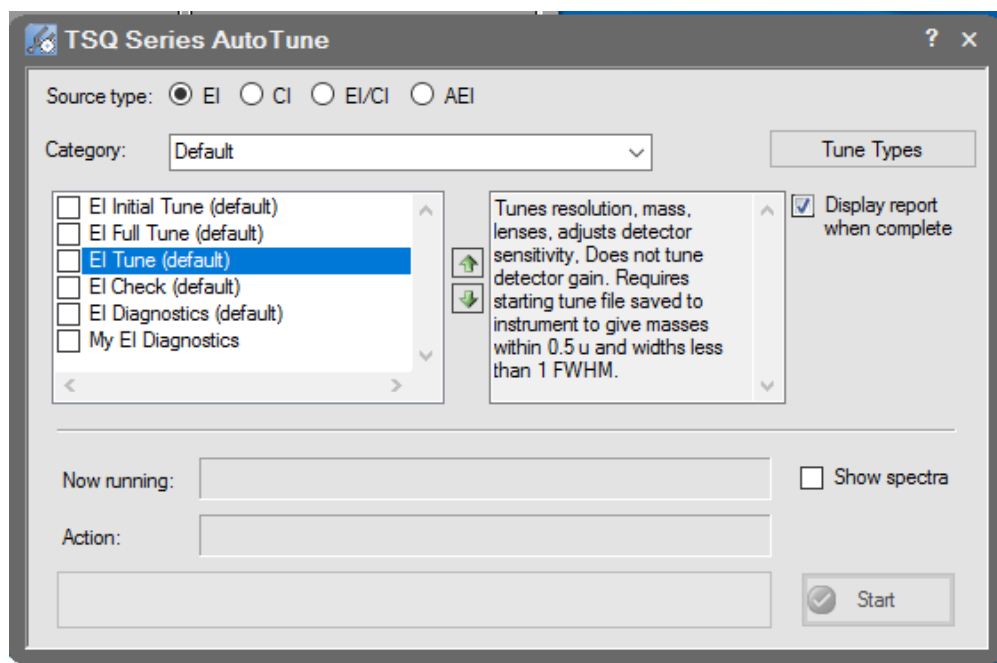
1. In the Tune Types field, select EI, CI, or AEI, depending upon which ionization mode you are using. Select a tuning category and tune type. See [Figure 52](#).

**Figure 52.** Tune Types



2. Select the **Display Report When Complete** check box so that you can view the tune report after running the tune.

Figure 53. Displaying a Report



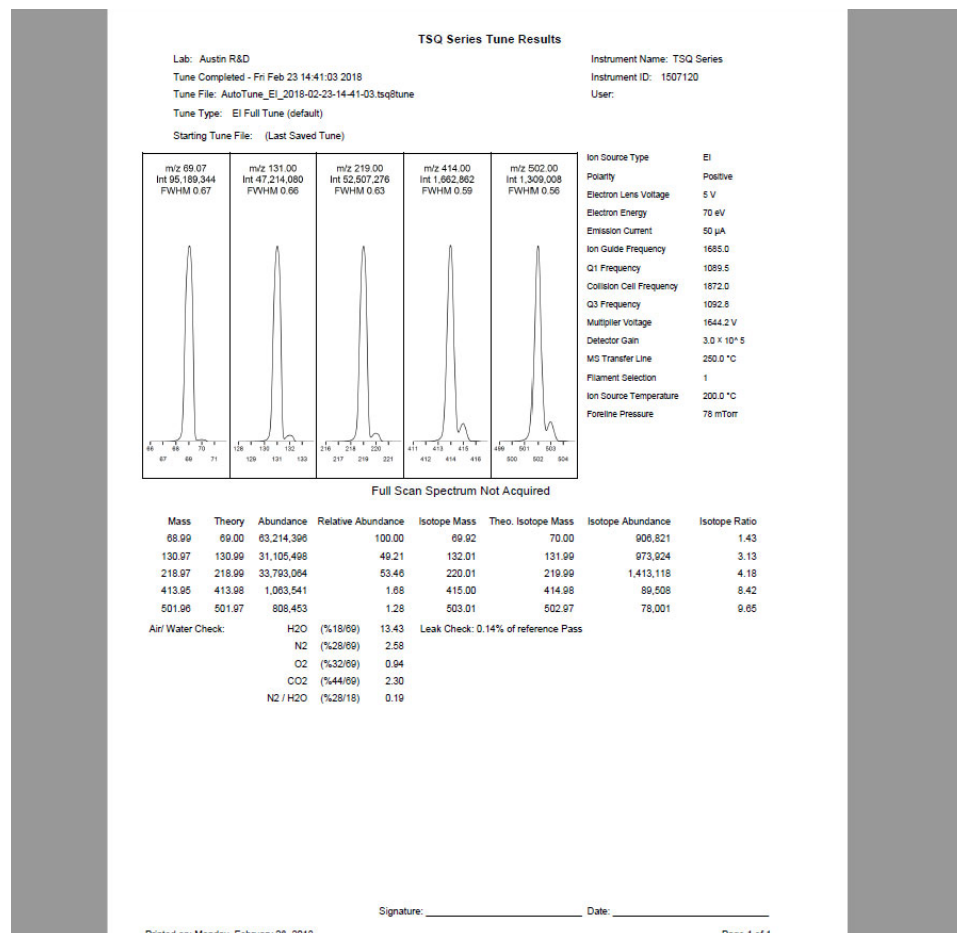
3. Select the **Show Spectra** check box to show the spectra while the system is tuning.
4. Click the **Start** button to begin tuning.

**Note** Make sure the power options on your computer are not set to go into Standby mode while you are acquiring data for your tune. Select High Performance to prevent network adapters, disk drives, and other needed devices from powering off. Otherwise, it will interrupt your tune.

Once the tune completes, your tune report opens in the *Tune Results Viewer*. If you did not select the **Display Report When Complete** check box, you can click **View Tune Report** on the dashboard and view the report.

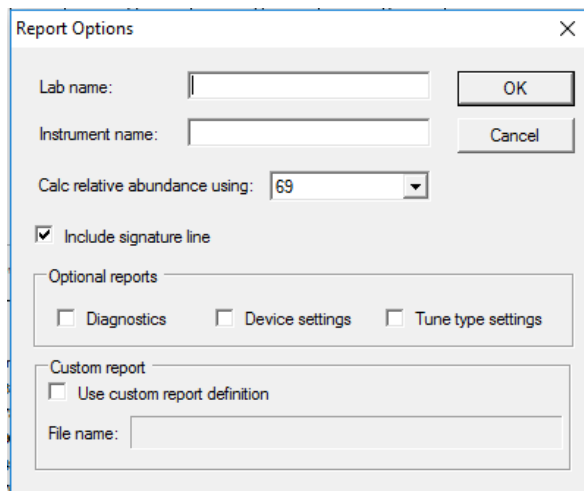


Figure 54. Sample Tune Report



5. Click **Report Options**. In the dialog box, select the charts and reports you want to display and change the name of your instrument.
6. Select a mass for **Calculate Relative Abundance Using**. The default is mass 69, which will reference all masses to mass 69. Some masses may have over 100% abundance. If you do not wish to have a relative abundance above 100%, select Base Peak. This option will select the reference mass as the highest abundance mass in the tune.
7. Click **OK**.

Figure 55. Tune Report Options



- To print your tune report, click **Print Report** to open a print dialog box and print your report.

**Note** Only tune the system as often as your application requires. Repeated tuning on an otherwise functioning system can cause abnormalities as each tune reoptimizes all parameters affecting the signal.

Figure 56. Printing a Tune Report

**TSQ Series Tune Results**

Tune Completed - Tue May 20 08:54:11 2014  
Tune File: AutoTune\_EI\_2014-05-20-08-54-11.tsq.tune  
Tune Type: EI Standard Tune  
Starting Tune File: (Last Saved Tune)

m/z	Int	m/z	Int	m/z	Int	m/z	Int	m/z	Int
69.07	85,102,896	131.00	42,896,724	219.07	38,226,292	414.00	1,030,205	502.00	713,177
	FWHM 0.67		FWHM 0.67		FWHM 0.65		FWHM 0.55		FWHM 0.50

Parameter	Value
EI Ion Source Type	EI
Polarity	Positive
Electron Lens Voltage	15V
Electron Energy	70 eV
Emission Current	50 µA
Ion Guide Frequency	1600.1
Q1 Frequency	1099.8
Collision Cell Frequency	1841.4
Q3 Frequency	1102.9
Multipole Voltage	1667.5 V
Detector Gain	3.0 × 10 <sup>-5</sup>
MS Transfer Line	310.0 °C
Flament Selection	1
Ion Source Temperature	349.9 °C
Foreline Pressure	90 mTorr
Ion Gauge Pressure	5.5 × 10 <sup>-6</sup> Torr

Mass	Theory	Abundance	Relative Abundance	Isotope Mass	Theoretical Mass	Isotope Abundance	Isotope Ratio
69.98	69.00	55,541,124	100.00	69.93	70.00	828,044	1.46
130.98	130.99	28,201,154	49.88	132.02	131.99	891,177	3.16
218.98	218.99	25,180,058	44.55	220.01	219.99	1,033,241	4.10
413.98	413.98	633,459	1.12	415.02	414.98	53,188	8.40
501.98	501.97	390,114	0.69	503.01	502.97	36,600	9.49

Air/Water Check: H<sub>2</sub>O (%18.69) 1.68, N<sub>2</sub> (%28.69) 4.05, O<sub>2</sub> (%32.69) 2.80, CO<sub>2</sub> (%44.69) 1.40, N<sub>2</sub>/H<sub>2</sub>O (%28.78) 2.41

Leak Check: 0.05% of reference Pass

Printed on: Wednesday, May 28, 2014

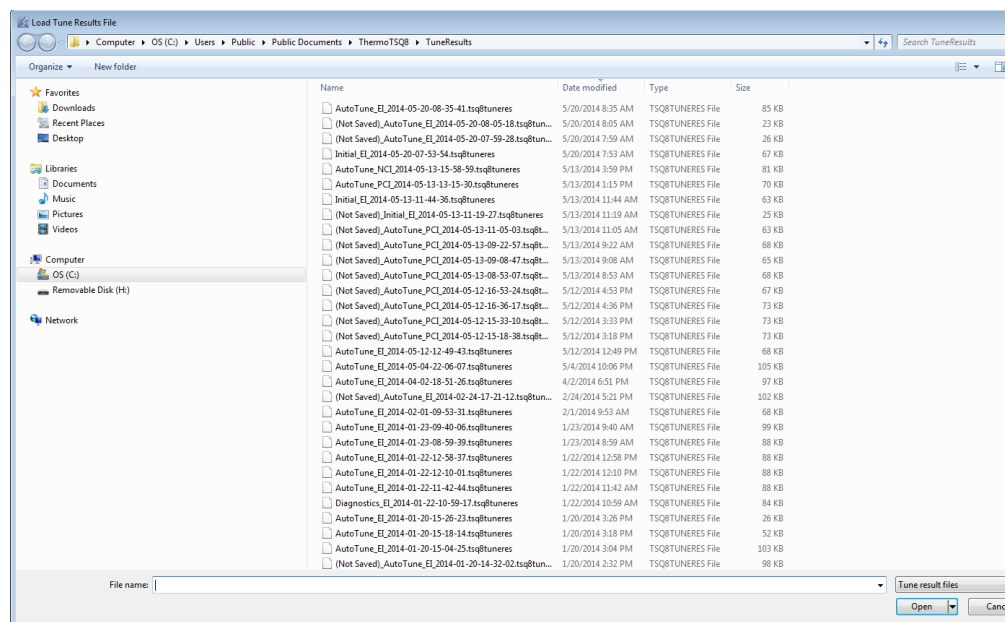
In the Tune Results window, you can open tune results, print reports, or change the way you view the report.

- To save the report in a format that can be read by computers without the instrument control software installed, click **Save Report to PDF**.

You may find it useful to compare this tune with a previous tune report of the same tune type. Some changes in peak height are normal, but if the difference is significant, see [Troubleshooting](#).

- To browse to another tune report on your computer, click **Open Tune Results** in the top of the window.
- Click **Open** to open a previously saved tune report.

**Figure 57.** Loading Tune Results



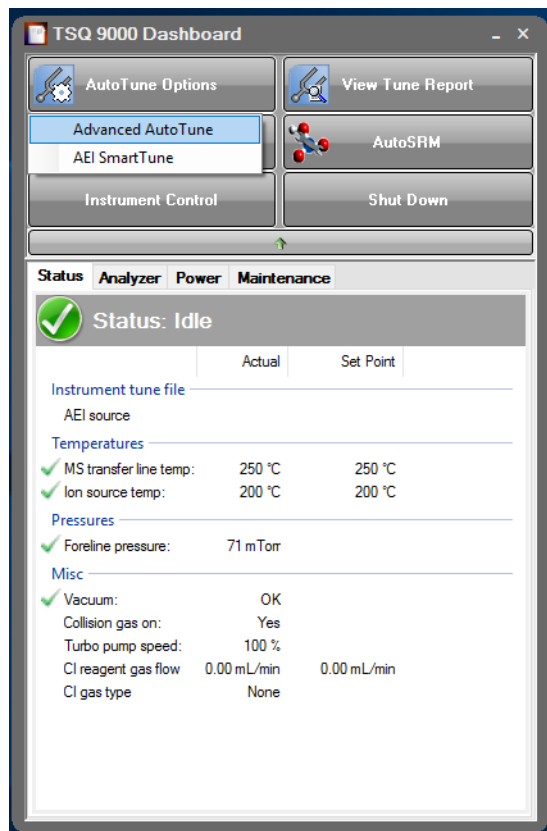
If the sensitivity and resolution are adequate for running your samples, you are ready to develop or run a method.

If you configured the TSQ Series software to use the **EI SmartTune** or **AEI SmartTune** application, follow the instructions below to use the application.

❖ **To use the SmartTune application in Xcalibur software**

- Right-click **AutoTune Options** on the TSQ Series Dashboard and choose **AEI SmartTune** or **EI SmartTune** depending on which ion source is installed on your instrument. See [Figure 58](#).

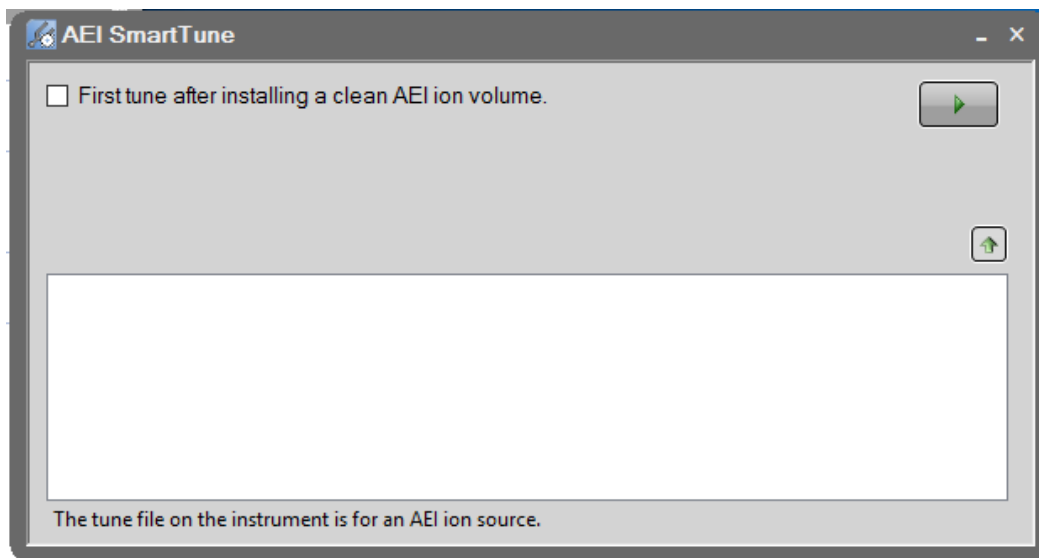
Figure 58. Opening the SmartTune Application



**Note** Dashboard buttons will change depending on instrument configuration. In the SmartTune tab of instrument configuration you can configure the dashboard to only show the SmartTune for the ion source installed. In this case, you may see a SmartTune button instead of an AutoTune Options button.

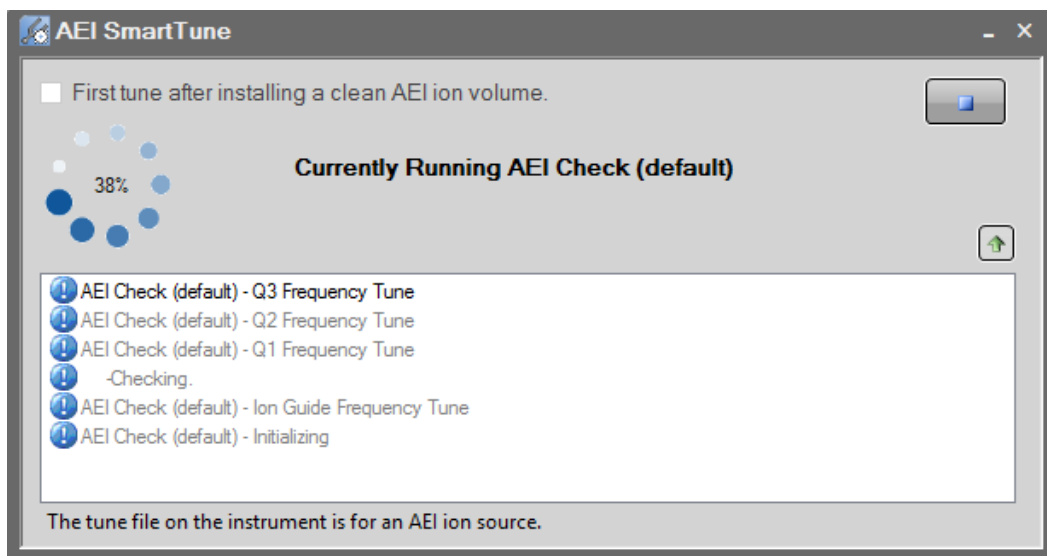
2. The SmartTune application opens. See [Figure 59](#).

**Figure 59.** Viewing the SmartTune Application



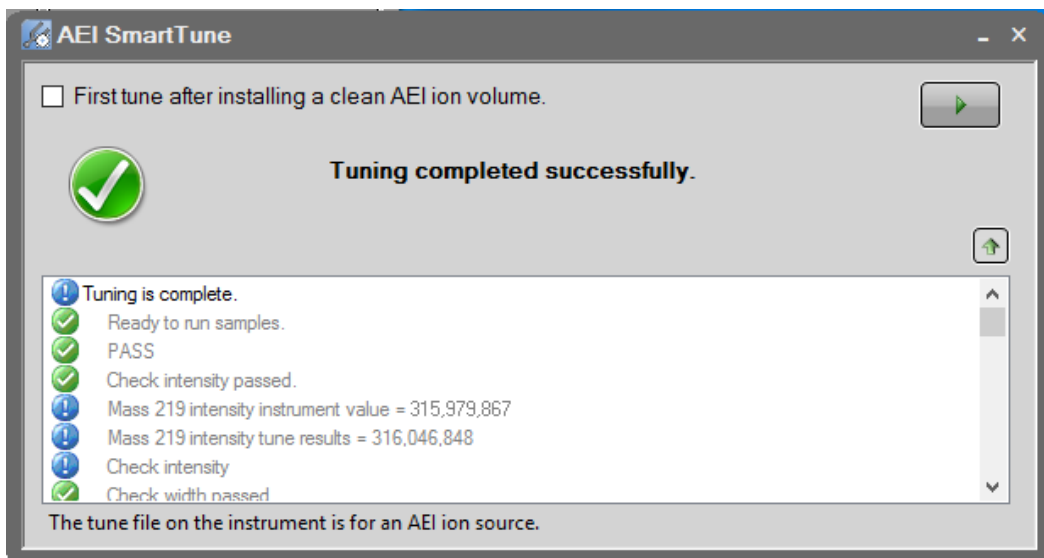
3. If this is the first tune after installing a clean ion source, check the box indicating that. Click the green arrow on the right side of the panel to start the SmartTune application.
4. The SmartTune application assess the state of your instrument and chooses the proper tunes for the system. The tunes run or running and the percent complete appear in the window while SmartTune is in progress. See [Figure 60](#).

**Figure 60.** SmartTune in Progress



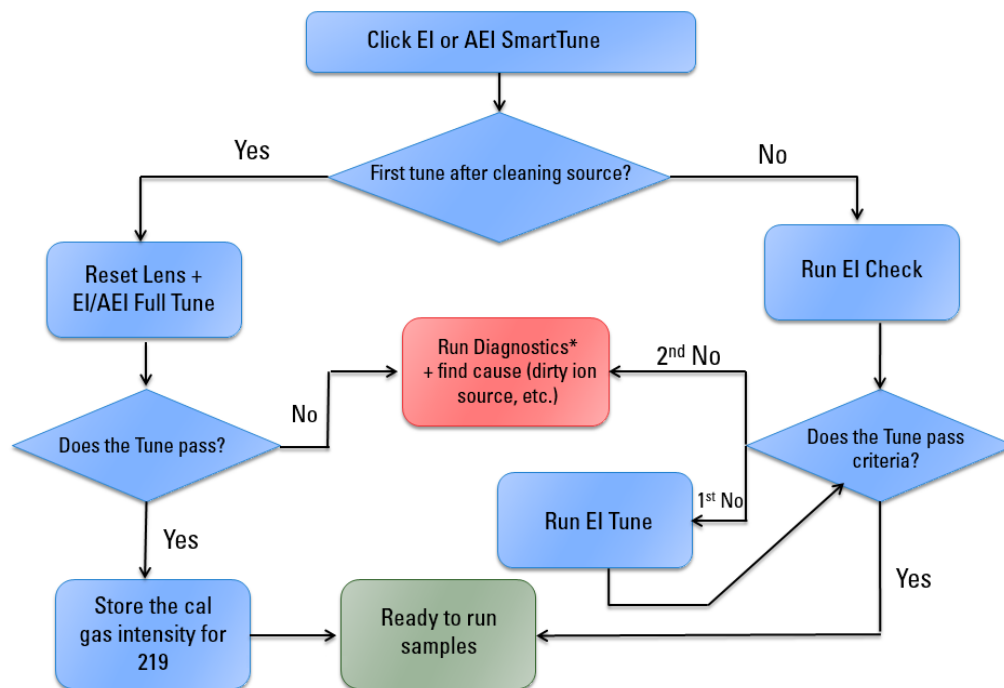
5. Once SmartTune has successfully completed tuning your instrument, you will see a green check in the SmartTune window and a brief summary of the results. See [Figure 61](#).

Figure 61. SmartTune Completed



6. View the tune report to see all the results of the SmartTune.
7. See Figure 62 below for the SmartTune workflow.

Figure 62. SmartTune Workflow

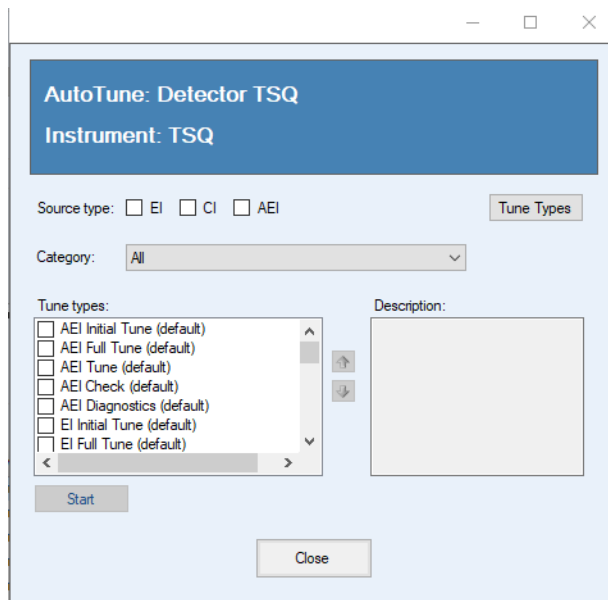


\*SmartTune does not run diagnostics when there is a tune failure due to high leak check or electron multiplier voltage.

❖ **To Tune the TSQ 9610 MS Using Chromeleon Software**

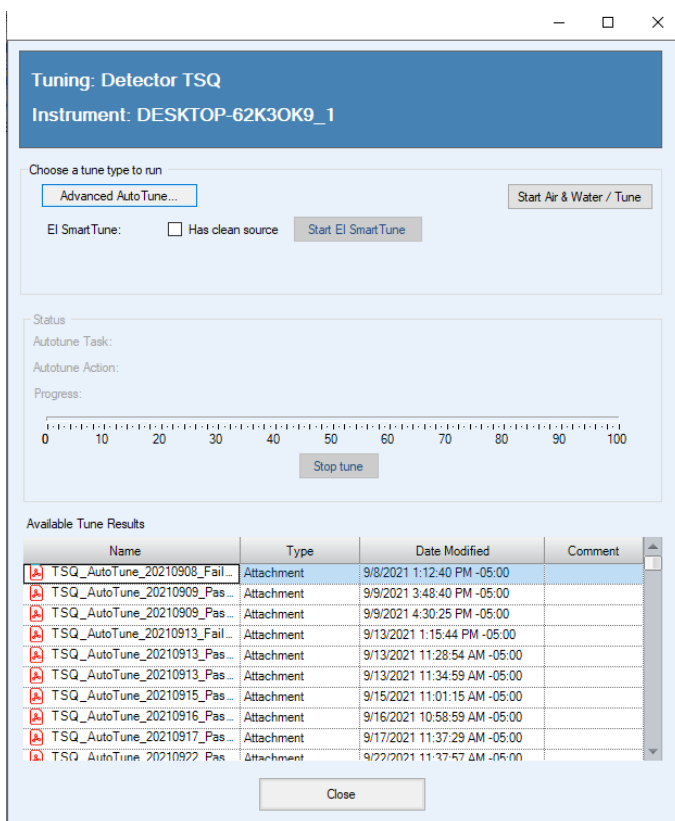
1. Choose a tune from AutoTune window. Click **Start**. See [Figure 63](#).

**Figure 63.** Tuning the TSQ 9610 Using Chromeleon Software



2. View the tuning status in the audit trail under the TSQ tab on the Chromeleon Console.
3. To open a tune report, go to the **Available Tune Results** on the **Tuning** panel. See [Figure 64](#).

Figure 64. Locating TSQ 9610 Tune Reports in Chromeleon Software



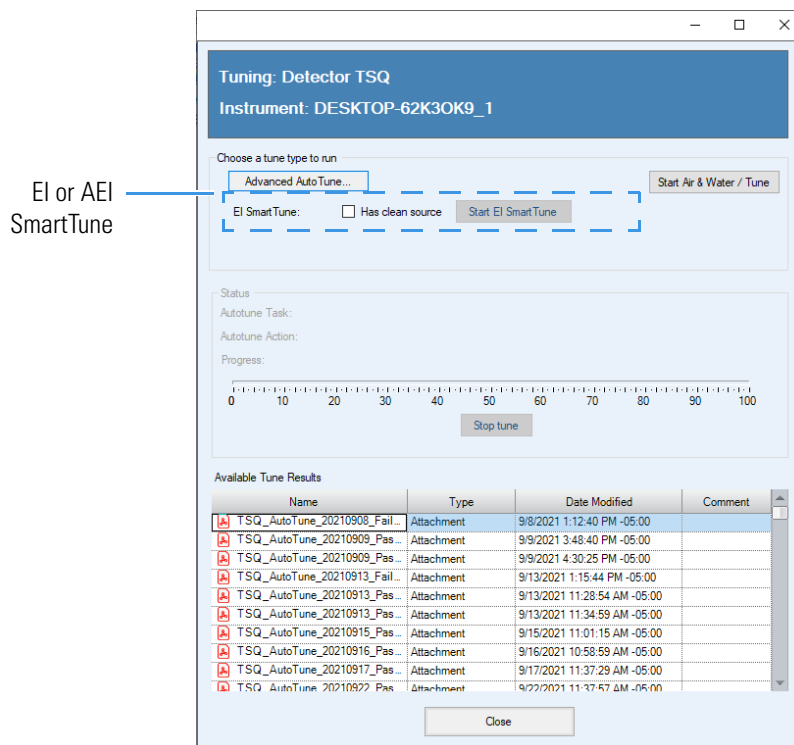
❖ **To use the SmartTune application in Chromeleon Software**

**Note** The MS configuration settings determine whether or not Advanced AutoTune and/or the EI or AEI SmartTune options are shown on this page. If they are missing, please check your configuration.

1. EI and AEI SmartTune are accessed in the **Tuning** window. Depending on which ion source is installed, the software displays **AEI SmartTune** or **EI SmartTune**. See [Figure 65](#).

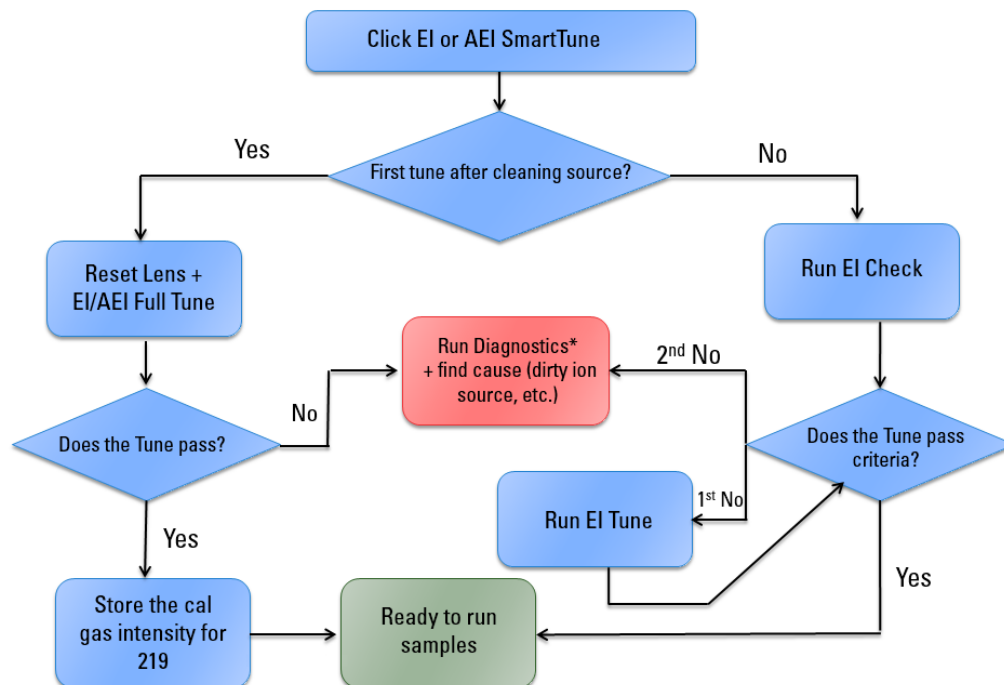


**Figure 65.** Accessing EI or AEI SmartTune in Chromeleon Software



2. If this is the first smart tune to be run after installing a clean ion source, check the **Has Clean Source** box.
3. Click Start **EI SmartTune** or Start **AEI SmartTune** depending on which ion source is installed on the system.
4. View the tune report to see all the results of the SmartTune.
5. See [Figure 66](#) below for the SmartTune workflow.

Figure 66. SmartTune Workflow



\*SmartTune does not run diagnostics when there is a tune failure due to high leak check or electron multiplier voltage.

## Creating a Method

Once you have tuned the TSQ 9610 system, you can create a method for each of its components. Use these methods to indicate to the GC/MS system how to collect your data.

### Contents

- [Accessing the Method Editor](#)
- [Creating a GC-MS Method in Xcalibur Software](#)
- [Creating a GC-MS Method in Chromeleon Software](#)
- [Validating and Troubleshooting Methods](#)

## Accessing the Method Editor

To create a method for the TSQ 9610 mass spectrometer, the GC, and your autosampler, use the Method Editor. The Method Editor is accessed differently on systems running Xcalibur software and those running Chromeleon software. This section provides instructions for accessing the Method Editor on both systems.

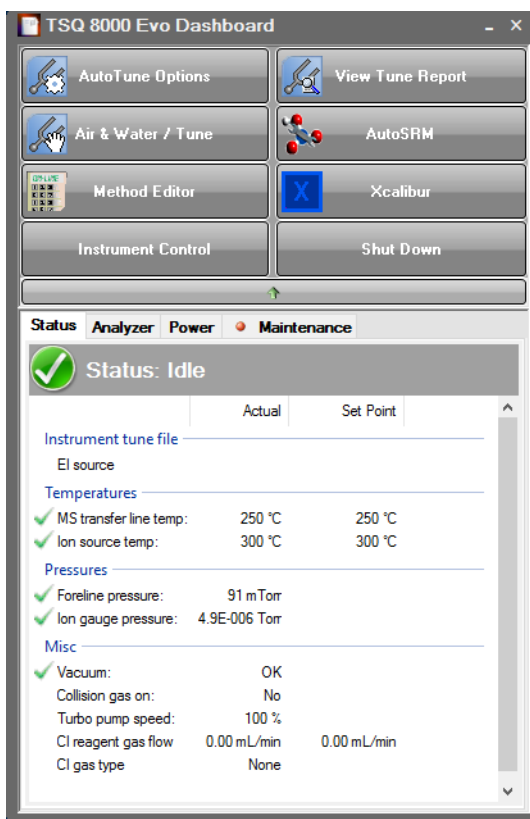
**Note** For information about creating a method for other instruments and software, refer to the appropriate documentation.

**Note** All of the configured instruments are shown in the left pane of the Instrument Setup window. If your instruments are not shown, you must configure them. See [“Configuring Your Instrument”](#) for instructions.

### ❖ To access the method editor using Xcalibur software

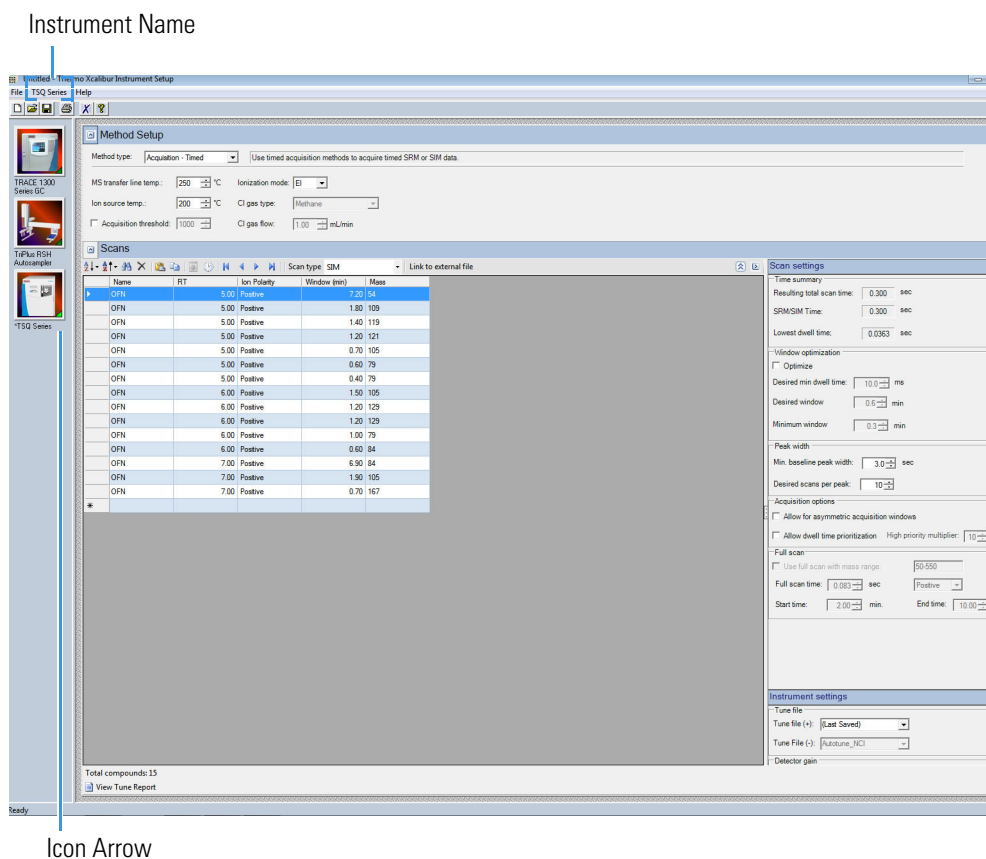
1. Click **Method Editor** on the TSQ Series Dashboard. See [Figure 67](#).

Figure 67. Accessing the Method Editor from the TSQ Series Dashboard



2. The Method Editor window opens. See Figure 68. Icons of all connected instruments appear in the left pane. You may only configure one instrument at a time. The bright green arrow on the lower right corner of the instrument icon indicates the active instrument. The current instrument name also appears in the main menu.

Figure 68. Method Editor Window



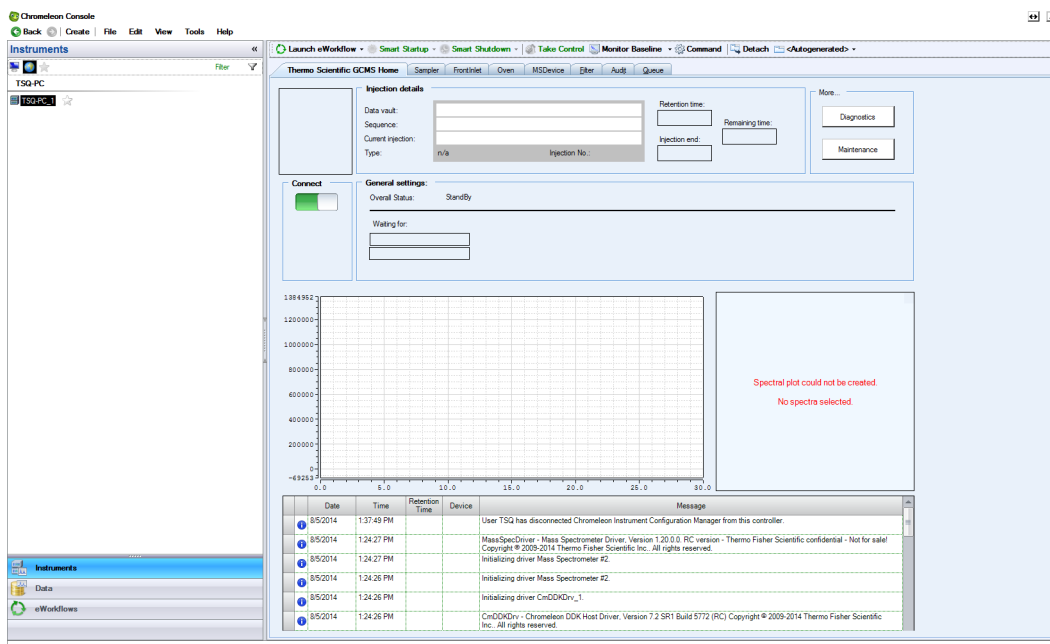
❖ To access the Method Editor using Chromeleon software

To access the Method Editor for the TSQ 9610 mass spectrometer, the GC, and your autosampler, go to **Start > Thermo Chromeleon > Chromeleon 7** and open the Chromeleon software application. The **Chromeleon Console** opens to the **Thermo Scientific GCMS Home Page**. See Figure 69.

## 4 Creating a Method

Creating a GC-MS Method in Xcalibur Software

**Figure 69.** Chromeleon Console: Thermo Scientific GCMS Home Page



**Note** All of the configured instruments are shown in the left pane of the Chromeleon Console window under **Instruments > TSQPCNAME**. If your instruments are not shown, you must configure them. See [“Configuring Your Instrument”](#) for instructions.

## Creating a GC-MS Method in Xcalibur Software

If your system is running Xcalibur software, follow the instructions in this section to create a method for the autosampler, GC, and TSQ 9610 mass spectrometer.

## Creating an Autosampler Method in Xcalibur Software

Use the method editor to create a method for the autosampler if you have one.

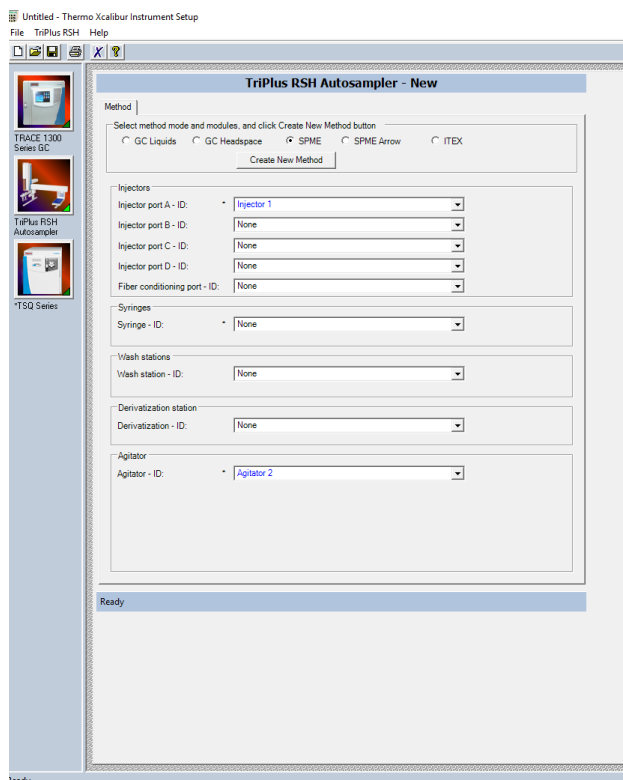
**Note** Instructions for setting the most common parameters for the TriPlus RSH Sampling System follow. Refer to your autosampler documentation for more detailed information about settings.

### ❖ To create a method for the autosampler

1. In the left pane, select the icon for the autosampler.

The method view opens. See [Figure 70](#).

**Figure 70.** Autosampler Method



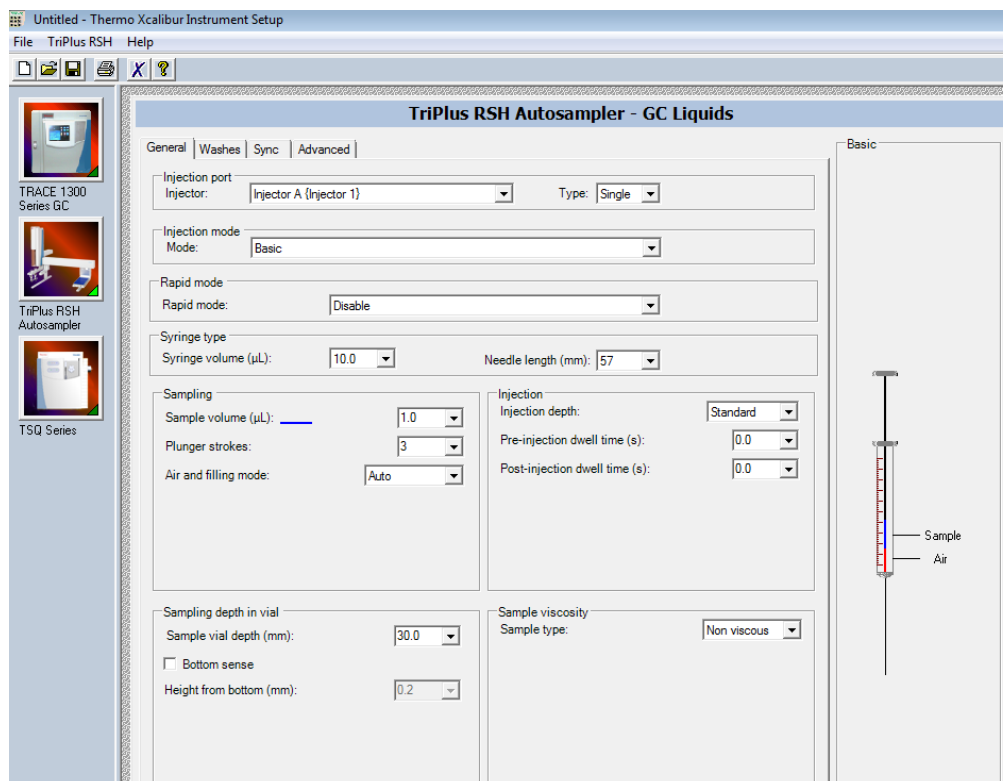
2. Choose one of these three options: **GC Liquids**, **GC Headspace**, **SPME**, **SPME Arrow**, or **ITEX**.
3. Enter the ID information for your samples. You must fill in any field with an asterisk (\*)
  - a. Injectors—Enter the injection ID into the corresponding injector port.
  - b. Syringes—Enter the syringe ID information.
  - c. Wash Station—Enter the wash station ID information.
  - d. (Optional) Internal Standard/Solvent Stations—Enter ID information for your solvent station or interval standard station.

## 4 Creating a Method

Creating a GC-MS Method in Xcalibur Software

- e. (Optional) Cooled/Heated Trays—Enter ID information for your primary and, if used, secondary trays.
4. Click **Create New Method**.
5. Use these instructions to configure the GC Liquids general method settings (see [Figure 71](#)):

**Figure 71.** General GC Liquids Settings on the TriPlus RSH Sampling System

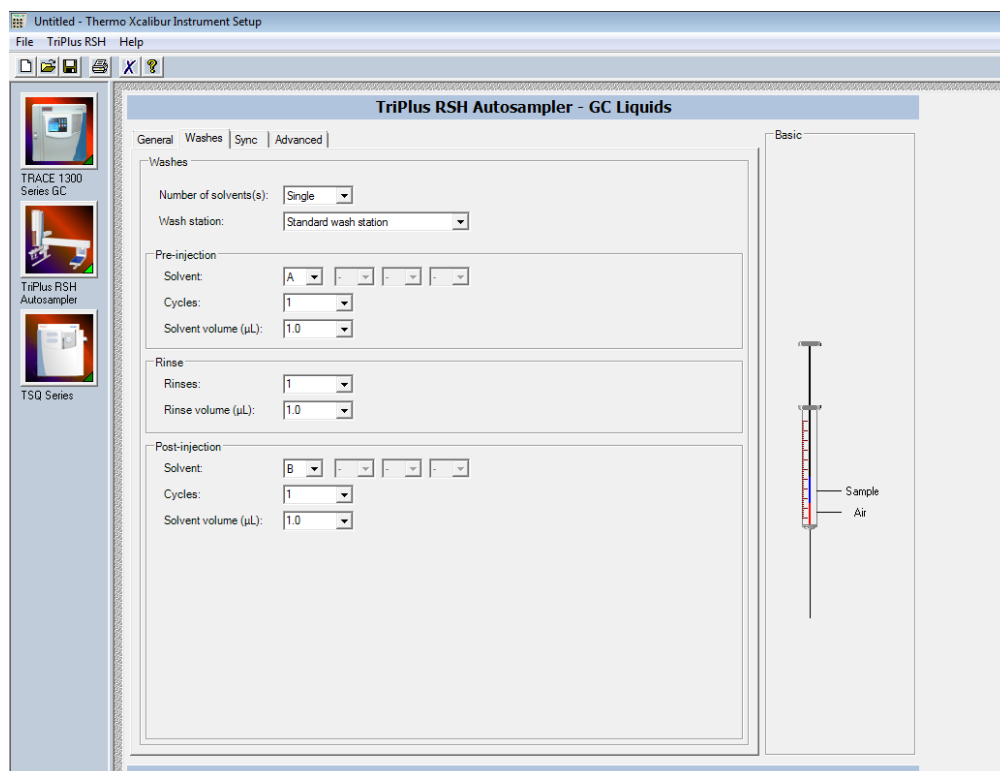


- a. Injector Type—Choose Single or Double for each injector.
- b. Injection Mode—Choose Basic, Enrichment, Enrichment Needle Solvent Option, Internal Standard Double, Internal Standard Post, Needle Solvent Wash, Solvent Flush Double, or Solvent Flush Post.
- c. Rapid Mode—Choose Disable, After Sample Rinse, After Bubble Elimination, or After Sample Asp. in Home.
- d. Syringe Type—Enter your syringe volume in  $\mu\text{L}$ . Enter the syringe needle length in mm.
- e. Sample Volume—Enter the sample volume to be injected into the GC. Typical values are between 0.5 and 5  $\mu\text{L}$ .
- f. Plunger Strokes—Select the number of plunger strokes to use when drawing up the sample. Air bubbles in the syringe change the amount of sample injected, which can cause signal variation in different runs. To prevent this from occurring, increase the



- number of plunger strokes to reduce the chance of an air pocket in your syringe. Typical values are between 3 and 10.
- g. Air and filling mode—Choose Auto to use the default or Custom to change the parameters.
  - h. Sample Viscosity—Select Viscous if your sample is viscous or Non Viscous if your sample is non-viscous. With a viscous sample, the syringe is filled more slowly than if it was non-viscous. Since the amount of time saved is so small, setting this option to Yes might be easier.
  - i. Sampling Depth in Vial—Select the Bottom Sense check box and enter the height from the bottom of the vial (in mm) at which the tip of the syringe needle will be placed in the sample vial when it is being filled.
  - j. Injection Depth—Select Standard or Minimum to indicate how the sample is introduced into the GC. If you select Standard, the autosampler inserts the needle all the way into the injection port. If you select Minimum, the autosampler barely enters the injection port.
  - k. Pre-inj Dwell Time(s)—Use this field to enter the time (in seconds) that the needle will be in the injection port before the plunger injects the sample.
  - l. Post-inj Dwell Time(s)—Use this field to enter the time (in seconds) that the needle will be in the injection port after the plunger injects the sample.
6. Configure the settings under the Washes tab (see [Figure 72](#)):

**Figure 72.** GC Liquids Washes Settings



## 4 Creating a Method

### Creating a GC-MS Method in Xcalibur Software

- a. Number of Solvents—Choose Single or Multiple depending on the number of solvents you will use for your method. You may choose up to four solvents: A, B, C, or D.
- b. Wash Station—Choose Standard Wash Station or Large Wash Station. Refer to the autosampler documentation for more information about the wash stations.
- c. Pre-injection—Use the Solvent and Cycles fields to set the number of solvent purges that will occur before the autosampler touches your sample. Always include some sample rinses, either before or after injection, to make sure you do not have sample carryover from one injection to the next. Configure the settings so that the syringe is purged with the same solvent that was used in location A, B, C, or D or with solvents A and B or C and D. Typically, there is 0 or 1 cycles of pre-injection purges.
- d. Rinse—Use the Rinses list to select the number of times the syringe is rinsed with your sample before each injection. Rinses help ensure the sample being injected is not diluted by the residual rinse solvents. By purging the syringe with your sample before injection, the dilution is minimal. The standard setting is between 1 and 3 rinses. If you have a very limited amount of sample, however, you may want to set this field to 0 to conserve the sample.
- e. Post-injection—Use the Solvent and Cycles fields to set the number of solvent purges that will occur after the autosampler touches your sample. You should always have some sample rinses, either before or after injection, to make sure you do not have sample carryover from one injection to the next. You can have the syringe purged with the same solvent that was used in location A, B, C, or D or with solvents A and B or C and D. Typically, there are 1 to 5 cycles of post-injection purges.

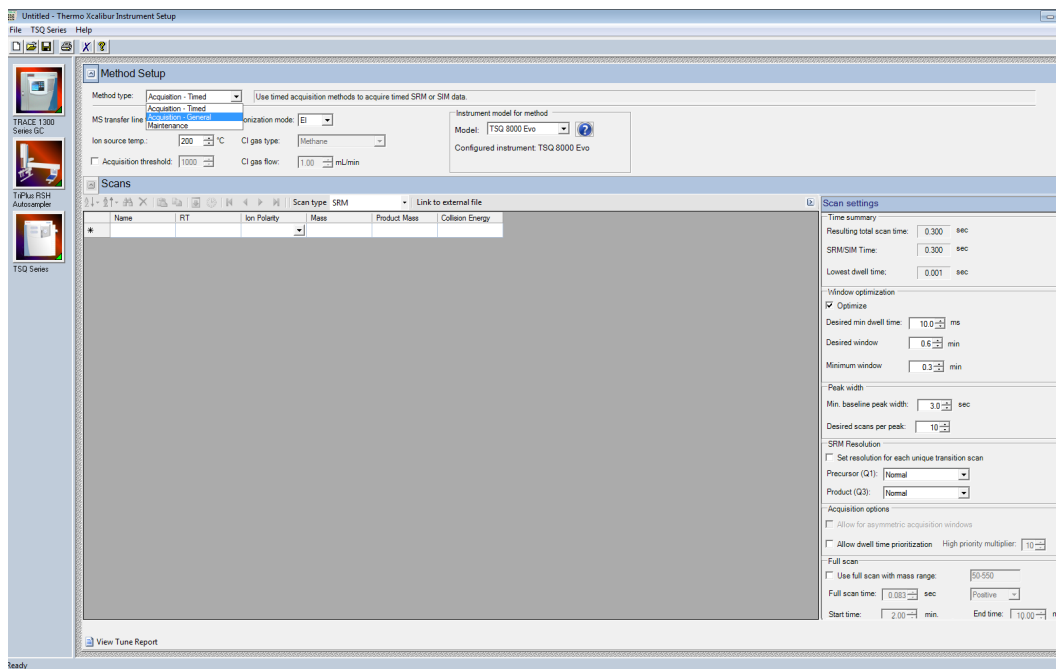
## Creating a MS Instrument Method in Xcalibur Software

Use the Method Editor to create an acquisition or maintenance method for the TSQ 9610 mass spectrometer using Xcalibur software.

### ❖ To create a method for the TSQ 9610 mass spectrometer

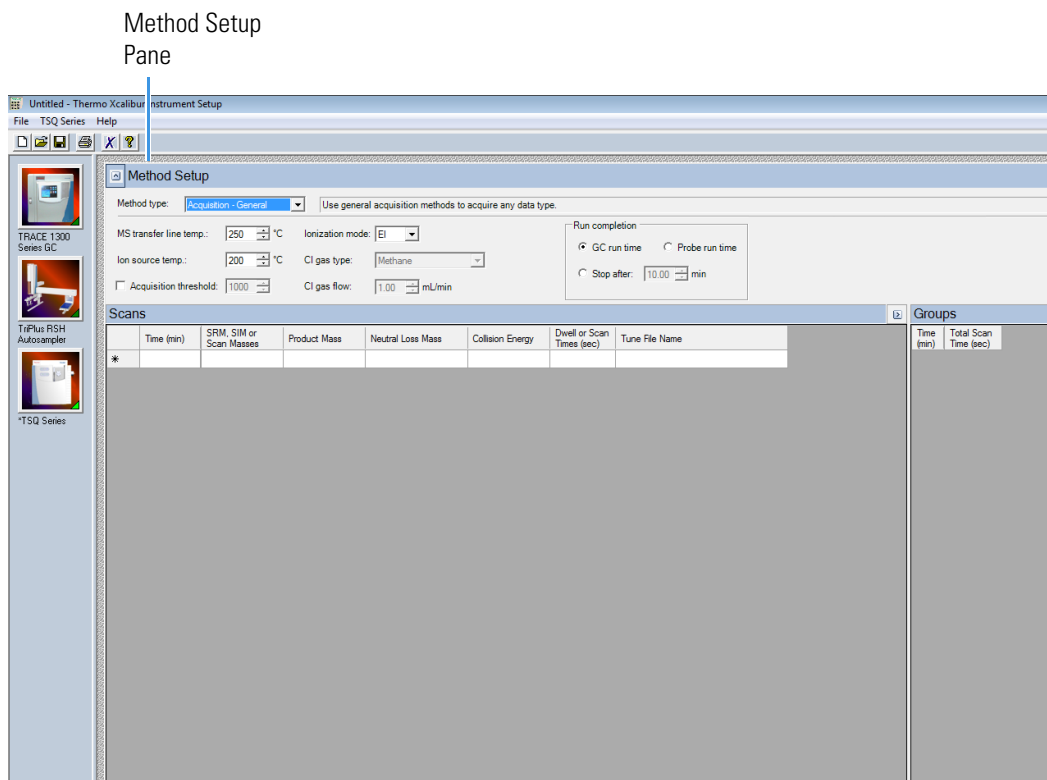
1. Click the **TSQ Series** icon in the left pane to open the method view for this instrument.
2. From the Method Type list, select **General Mode** or **Timed Mode**. See [Figure 73](#). An Acquisition method is used to collect data.

**Figure 73.** TSQ Series Method Type Setup



**Note** The **Maintenance** method is used to bake out or cool down the instrument during a sequence. This can be useful if you know you want to perform these tasks and you want to do them in an automated way as part of your sequence.

- Use the **Method Setup** pane to set the temperatures and acquisition threshold in General Acquisition mode. See [Figure 74](#) on [page 78](#).

**Figure 74.** General Acquisition: Setting Temperatures and Acquisition Threshold

- a. Set the **MS Transfer Line Temperature**. This field represents the temperature of the transfer line, which is the tube that contains the column as it leaves the GC oven and enters the TSQ 9610 system. The maximum allowable temperature is 400 °C.

**Note** The maximum transferline temperature of or the rate at which higher transfer line set temperatures may be reached can depend upon the ion source temperature and the GC oven temperature.



**CAUTION** You will damage the column and contaminate the TSQ 9610 instrument if you set the transfer line temperature above the maximum allowed temperature for the column. For most polyimide-coated columns, damage begins to occur when the column is held at a constant temperature above 280 °C.



**ATTENTION** Si vous configurez la température de la ligne de transfert au-dessus de la température maximum autorisée pour la colonne, vous endommagerez la colonne et contaminerez l'instrument TSQ 9610. Pour la plupart des colonnes à revêtement polyimide, les dommages commencent à se produire lorsque la colonne est maintenue à une température constante au-dessus de 280 °C.

- b. Set the **Ion Source Temperature**. You can enter a value between 0 and 350 °C. The optimal temperature depends on the analyte. Higher temperatures will keep the ion source cleaner, but will lead to increased fragmentation, which may reduce sensitivity.
- c. (Optional) Select the **Acquisition Threshold** check box and enter a value for the minimum peak height for the data file, if needed. If your peak has an intensity that is below this threshold, it will not be stored. This setting may help reduce noise, but it may also alter the reported isotope ratios because the smaller isotope signals might be preferentially lost.
- d. Select **EI** or **CI** from the **Ionization Mode** pull-down menu.

**Note** Only use CI if you have installed a CI ion volume in the MS and connected CI reagent gas to your system. If you have CI, select a CI Gas Type from the pull-down menu and set the CI Gas Flow. Typical values for Methane CI for NCI are 1.0–1.5 mL/min. For Methane CI for PCI, the gas flows are typically 1.5–2.0 mL/min. Click the **Apply to All Groups Button** at the top of the method editor. The single value at the top of the method is sent when initializing the MS with the method. See [Figure 76](#).

- e. To assign gases to the CI gas ports, open the TSQ 9610 Dashboard and click **Instrument Control**.
- f. Set CI Gas Port A or CI Gas Port B to the appropriate CI gas attached to that port. You may only use one CI Gas Port per method.

**Figure 75.** Setting the CI Gas Ports

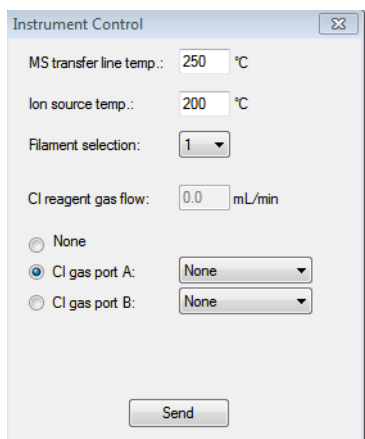
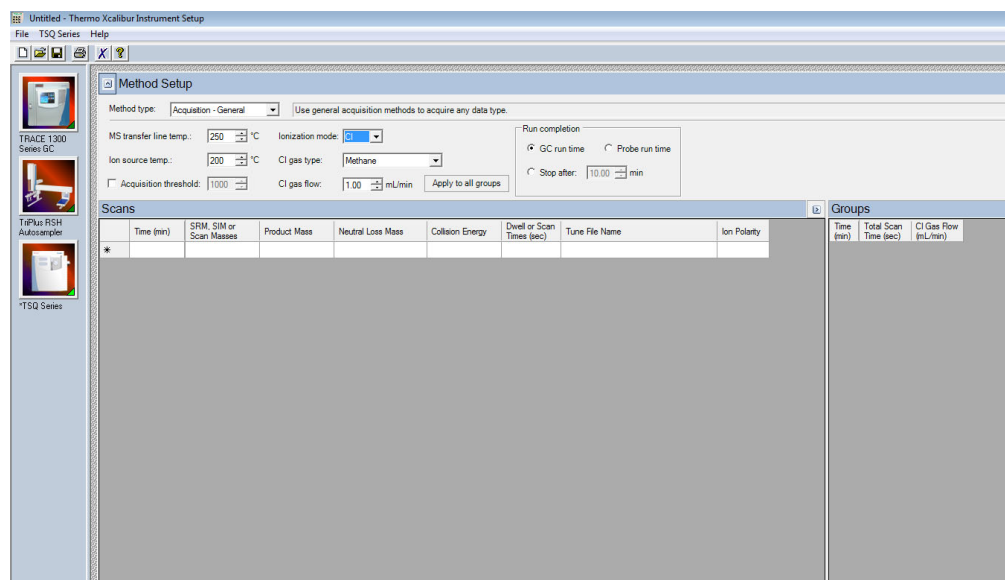


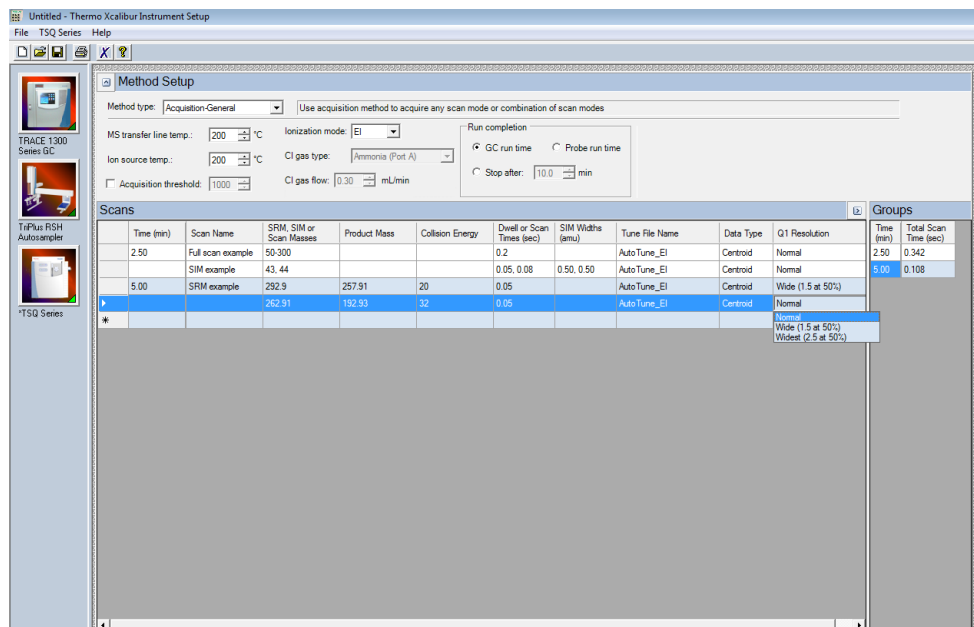
Figure 76. General Mode CI Settings



**Note** The following parameters apply only to the **General Mode** method type only. **General Mode** is the recommend setting for full-scan only MS methods, or simple SIM or SRM methods. If you need to develop a complex SIM or SRM method with a large compound list or overlapping retention times, refer to the instructions for **Timed Mode**.

4. For General Mode methods only, do the following:
  - a. In the **Run Completion** group, select the condition under which the run will end.
    - **GC Run Time**—Select this option if you want the MS run to end when the GC run is complete.
    - **Probe Run Time**—Select this option if you have a probe controller installed and you want the MS run to end with the probe run is complete.
    - **Stop After**—Select this option to set the number of minutes you want the MS to run. The end of the run can be between 0 and 1000 minutes. With this option you can stop the acquisition when all the compounds of interest have eluted, but the GC is still at an elevated temperature to keep the column clean. Thermo Fisher Scientific recommends that you select this option to save burn time on the filament.
  - b. In the Scans pane, click a scan row to enter scan information under each column. See [Figure 77](#).

**Figure 77.** Setting General Mode Scan Information



**Note** If some of the following columns are not shown in the Scan pane, you can right-click and display them. You can also reorganize the columns by clicking the heading of a column and dragging it to the left or right.

- i. Use the **Time (min)** column to set the time that the MS begins to acquire the scan group. Set the time for the first group late enough to allow the solvent to move through the system, and early enough to ensure the first analyte will be captured in the segment. Set subsequent segment times so that the start time will occur between compounds of interest. You may set up different types of scans in a single group. The scans will occur in descending order.

Your method may allow sequential full scans and SIM scans of a compound. As an example, in this method, the mass range of 50–300 will be scanned in 0.2 seconds. Immediately after the full scan finishes, the SIM scans begin. The SIM scans occur sequentially. Two different SIM masses, at 43 and 44, will be looked at for 0.05 and 0.08 seconds, sequentially. These simultaneous full scan and SIM scans will begin 2.5 minutes into the GC run. You will get a complete set of scans every 0.342 seconds. At 5 minutes into the GC run, the scans change to a set of SRM scans. The first SRM transition is 292.9 to 257.91 with a collision energy of 20 eV. The second SRM transition is 262.91 to 192.93 with a collision energy of 32 eV. Both SRM scans have a dwell time of 0.05 seconds. You will get a complete set of scans every 0.108 seconds.

**Note** The faster the MS scans, the more data points across a peak it will acquire. However, the precision of individual scans may be reduced.

## 4 Creating a Method

### Creating a GC-MS Method in Xcalibur Software

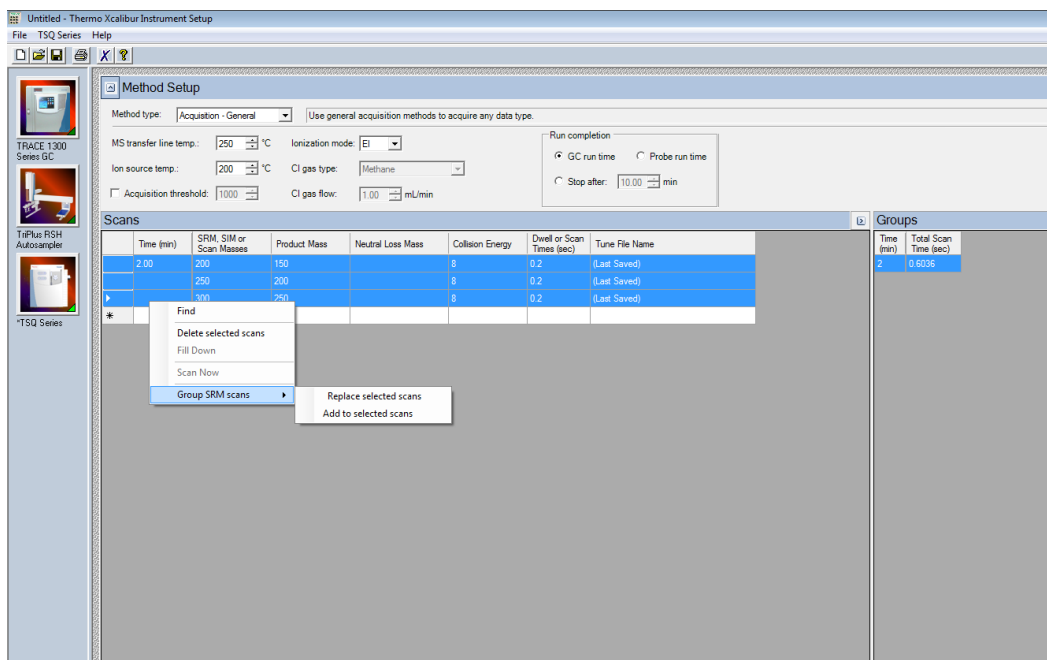
All of these scans use the most recent AutoTune\_EI file. You can also use a specific tune file for each of the scans.

- ii. Use the **SRM, SIM, or Scan Masses** column to tell the MS which masses to scan.
  - In full-scan mode, enter the start and end mass separated by a dash. You must put each full-scan range on a separate line.
  - For SRM methods, enter precursor masses, product masses, and collision energies of the ions you wish to monitor. Separate scan filters will be created for each SRM transition during acquisition.

**Note** Each line in a scan must only contain a full-scan range, individual SIM masses, or an SRM transition. Scan types cannot be mixed in a single line. Set up simultaneous scans by giving them the same time in the **Time (min)** column.

- If you would like to combine multiple SRM transitions in a single scan filter, highlight the rows you want to combine and then right-click and select **Group SRM Scans | Replace Selected Scans**. See [Figure 78](#). You can also use this function to ungroup a group of SRM scans into individual rows.

**Figure 78.** Grouping SRM Scans



- iii. Enter the product ion mass (for SRM methods) in the **Product Mass** column. The product ion mass is the result of fragmenting the precursor ion with collision gas. If you want to perform a precursor ion scan, enter the mass of the target precursor ion into this column.

**Note** Entering a product ion mass changes a scan to SRM.



- iv. Use the **Neutral Loss Mass** column when you want to perform a neutral loss scan. Enter the mass of the target precursor ion in this column. The scan mass range must be at least 2.5 amu wide and must begin at 1 + the precursor ion mass.
- v. In the **Collision Energy** column, enter the collision energy (for SRM methods) in eV. The collision of a precursor ion with the collision gas at a particular energy fragments the precursor ions into product ions. By varying the collision energy, a single precursor ion can be fragmented into several product ions. An SRM transition is defined by a precursor ion being fragmented into a particular product ion mass using a certain collision energy. The Collision Energy column is unusable unless you define a precursor and product ion mass.

**Note** The system controls the collision gas so it will be ready when an MS/MS scan is requested.

- vi. In SIM or SRM mode, use the **Dwell or Scan Times** column to define the amount of time (in seconds) that the MS will look at your SIM ion mass or your SRM product ion mass. If you are in full-scan mode, the **Dwell or Scan Times** column determines the amount of time to scan across the designated range. Set this value to have 5–20 scans across your GC peak. If you have too few scans, the GC peak area is inaccurate. If you have too many scans, the MS signal becomes less precise. This column must be set to a value between 0.0005 and 5 s for SRM and SIM methods. The default is 0.2 s. For full scan methods, the minimum scan time depends on the mass range so that the scan rate does not exceed 13,000 amu/s.
- vii. Use the **Tune File Name** to select a tune file to be used for this scan. Select the AutoTune file you created in [Chapter 3, “Tuning,”](#) . If you wish to use the same tune file for multiple scans, you can fill down this column by right-clicking on a tune file name.

**Note** Selecting a tune file to open without a date-time stamp opens the most recent tune of the tune type selected. To use a specific tune file, select a tune file of that prefix with the date-time stamp that you want.

**Tip** Use a tune file without the date-time stamp to create your method.

- viii. (Optional) Use the **Scan Name** column to enter a description of the scan. You may use the name as a label to indicate the compound used with the scan.

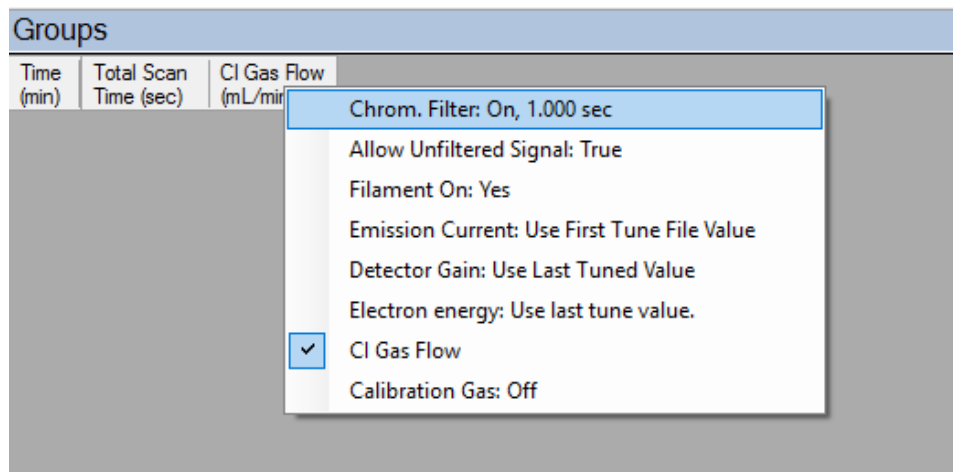
**Note** Scan Name, SIM Widths, Data Type, and Q1 Resolution columns are not shown by default. To view them, right-click one of the column headers to pull up the menu to display the hidden columns

- ix. Use the **SIM Widths** column to set the width range of the SIM window. The range of values can be between 0.01 and 10. The default is 1 amu, which means the MS will collect all the ions from your SIM mass  $\pm 0.5$  amu.

- x. Use the **Ion Polarity** column if you are using CI mode to tell the instrument to generate positive or negative ions. Only use this column if you are using CI mode. In EI mode, this column should always be set to **Positive**.
- xi. Use the **Data Type** column to select whether you want to collect **Profile**, **Centroid**, or **Nominal** mass spectra. Centroided mass spectra are the most common because they are used by most of the libraries and provide the smallest data files. Profile mass spectra provide detailed mass spectral peaks, which result in large data files. Profile mass spectra are not available for SRM scans. when you want to perform fast scanning (up to 20,000 amu/s), select **Nominal** from the drop-down list under **Data Type**.
- xii. Use the **Precursor (Q1) Resolution** column to open the peak width of the precursor mass for SRM scans. The options are **Normal**, **Wide (1.5 at 50%)**, **Widest (2.5 at 50%)**, or **Custom**. The default setting is Normal, which uses the tuned resolution values from the tune file specified in the **Tune File Name** column. Selecting Wide or Widest increases the precursor peak width to 1.5 and 2.5 amu (at 50%) respectively. Opening the precursor peak width will increase the ion signal into the collision cell and may improve the sensitivity of your method; however, it may also increase the background noise level. Set Custom width in the tune types. If using the default tune types, Custom width is 1.2 FWHM.
- xiii. Use the **Product (Q3) Resolution** column to open the peak width of the product mass for SRM scans. The options are **Normal**, **Wide (1.5 at 50%)**, **Widest (2.5 at 50%)**, or **Custom**. The default setting is Normal, which uses the tuned resolution values from the tune file specified in the **Tune File Name** column. Selecting Wide or Widest increases the precursor peak width to 1.5 and 2.5 amu (at 50%) respectively. Set Custom width in the tune types. If using the default tune types, Custom width is 1.2 FWHM.
- c. In the **Groups** pane on the right, review the information in each row. See [Figure 79](#). As you create scans in the Scans pane, information in the groups pane is automatically displayed.

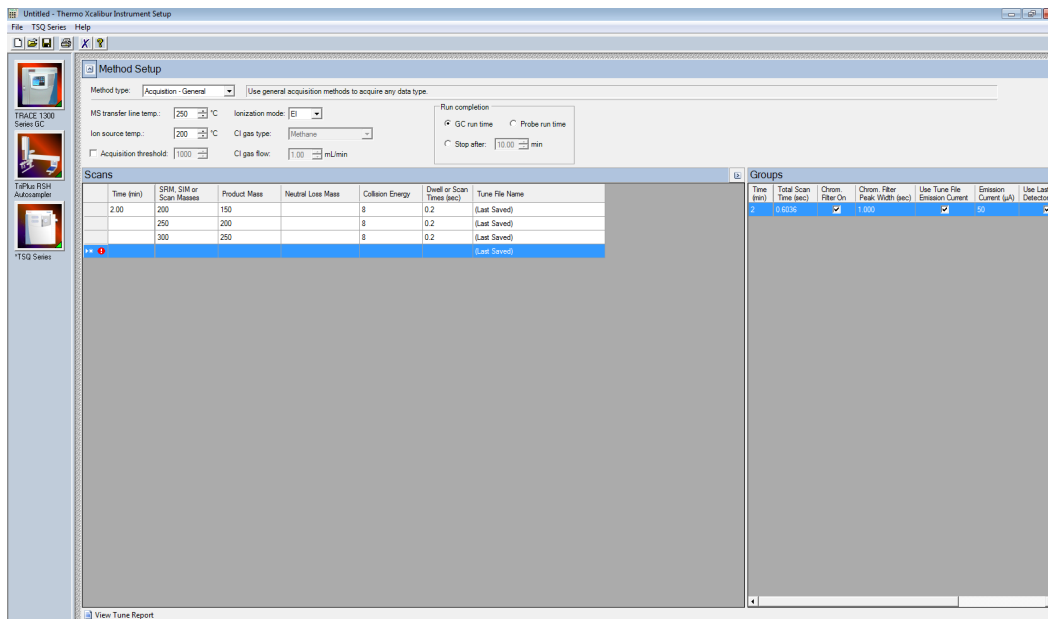
**Note** By default not all columns are displayed in the Groups pane. Right-click a heading to display them. You can also reorganize the columns by clicking the heading of a column and dragging it to the left or right.

**Figure 79.** Accessing the Groups Pane



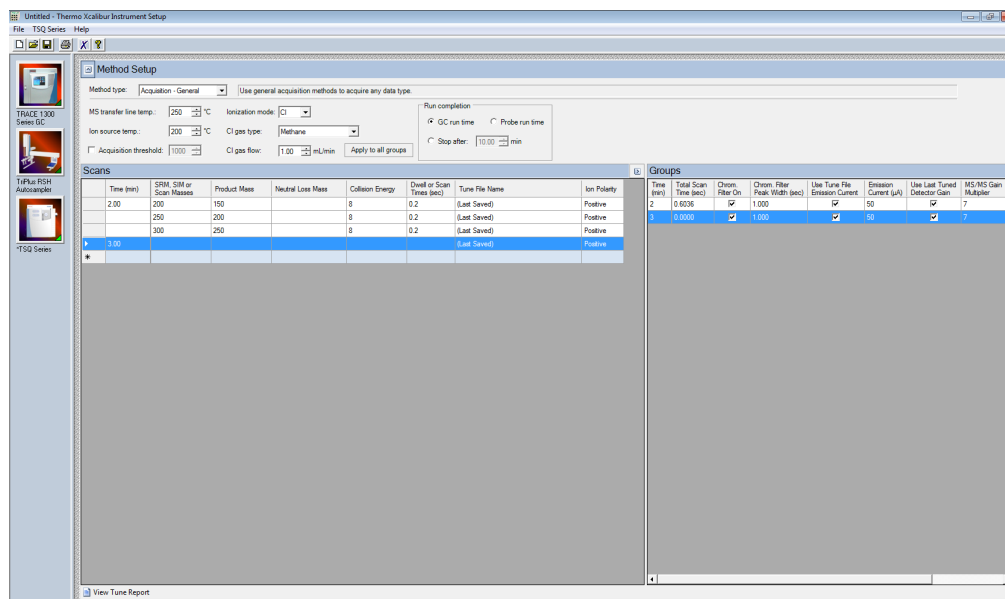
- i. The **Time (min)** column indicates the time that the MS begins to acquire data after the GC starts for that group. It is typical to have enough of a time delay for the start of the first group to allow the solvent to get through the column before starting acquisition. The Time column in the group pane cannot be modified. If necessary, modify the scan time in the Scans pane.
- ii. The **Total Scan Time (sec)** column indicates the sum of all the scans in each segment. See [Figure 80](#). The total scan time also contains the stabilization time that occurs between each scan. This method, beginning 2.5 minutes into the GC run, gives you a complete set of scans every 0.342 seconds. At 5 minutes into the GC run, the scanning completely changes. Now the scans will repeat every 0.108 seconds until the GC run is complete. As the total scan time is a calculated value, it is not editable.

**Figure 80.** Determining Groups Total Scan Time



- iii. Use the **Chrom Filter On** column to enable the chromatographic filter. This filter smooths spectral data as it is acquired, which may increase the signal-to-noise ratio by a factor of two or more. The chromatographic filter is most useful when at least four full scans are acquired across a GC peak. This setting is typically left on.
- iv. Use the **Chrom Filter Peak Width** column to set the peak width to match the width of the GC peak (in seconds). If the peak width is set too large, signal intensity may be reduced. The default value is 1 s.
- v. Use the **Allow Unfiltered Signal** column for most methods. To improve integration of congeners, the box must be checked. Leaving the box unchecked helps improve the signal-to-noise ratio for resolved chromatographic peaks. This feature is not checked by default in General Acquisition mode.
- vi. Use the **Filament On** column to turn the filament on and off in the selected segment. Turning off the filament increases the lifetime of the filament and keeps the ion source clean longer. However, no data is collected. Use this column if you had analytes eluting before the solvent peak. You can create a segment to turn off the filament during the solvent peak to preserve the filament.
- vii. Use the **Emission Current** column to set the emission current used during the acquisition. For optimal analytical performance and stability, use the emission current at which the system was tuned. However, if you want to use a different emission current, clear the **Use Tune File Emission Current** check box and enter a value in the **Emission Current ( $\mu\text{A}$ )** column. A high emission current will lead to the production of more ions, but the interaction of too many ions in the source can cause a degradation in the resolution and signal. The margin of error is  $\pm 0.5 \mu\text{A}$ .
- viii. Use the **Use Last Tuned Detector Gain** column to indicate that you want to use the detector gain set in Auto Tune. If you do not need to use the gain set in Auto Tune or saved to the instrument in Manual Tune, then you can set the gain manually. Higher gains give larger signals, but may shorten the lifetime of the detector when concentrated samples are detected.
- ix. Use the **CI Gas Flow** column to set the flow rate of your reagent gas. Click the **Apply to All Groups Button** at the top of the method editor. The single value at the top of the method is sent when initializing the MS with the method.

Figure 81. General Mode CI Settings



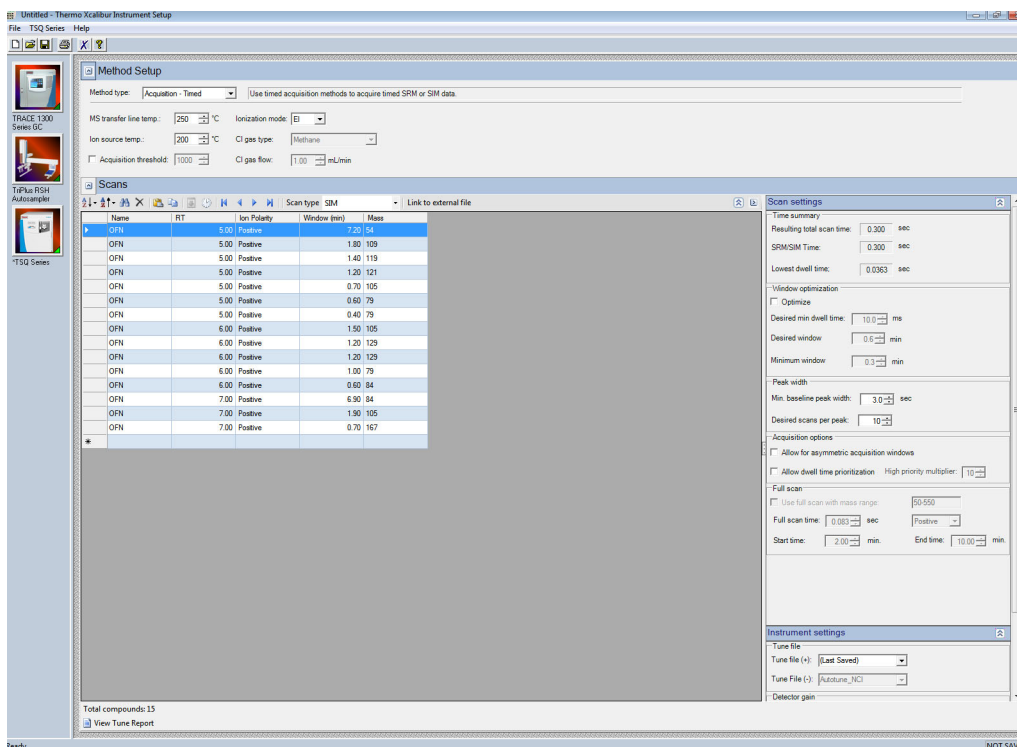
- x. The **MS/MS Gain Multiplier** column only applies to groups with MS/MS events. The MS/MS gain multiplier only applies if the **Use Last Tuned Detector Gain** column is selected. The default MS/MS Gain Multiplier is 7 and is intended to give similar signal levels as a SIM scan on the precursor ion. If you enter a specific gain, the MS will use that gain for the SRM scan without the multiplier.

- 5. The following settings apply to **Timed Mode** methods only.

## 4 Creating a Method

Creating a GC-MS Method in Xcalibur Software

Figure 82. Timed Mode Method Settings

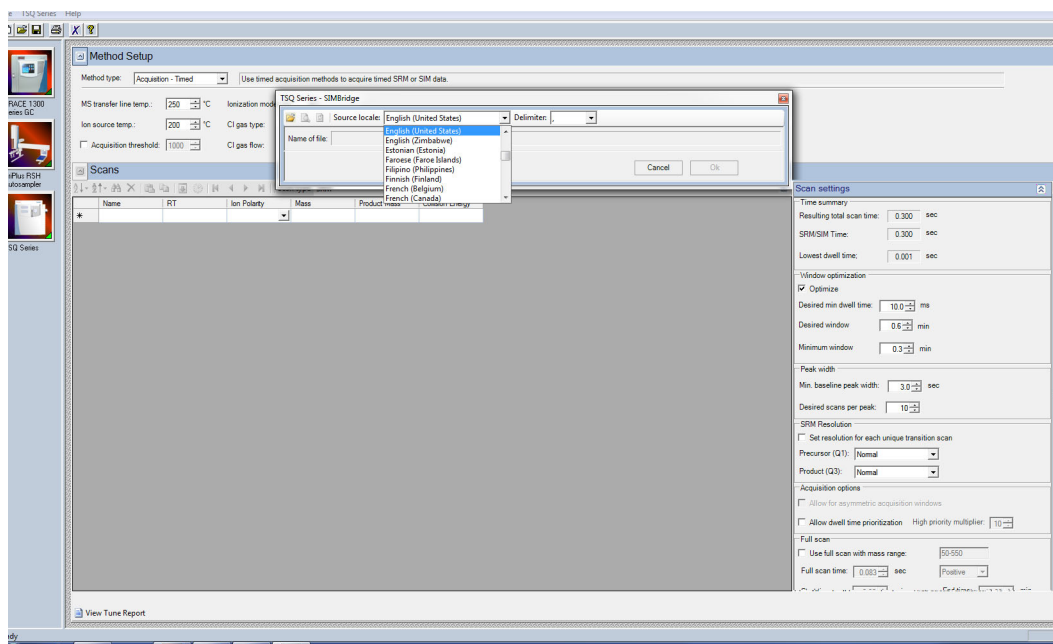


- In the **Scans** pane above list of scans, select **SIM** or **SRM** from the **Scan Type** list. If you want to link to an external method, click **Link to External File**. You may link to a .csv or .xml method file.

**Note** In order to edit the scans within the TSQ Series method editor, clear the **Link to External File**.

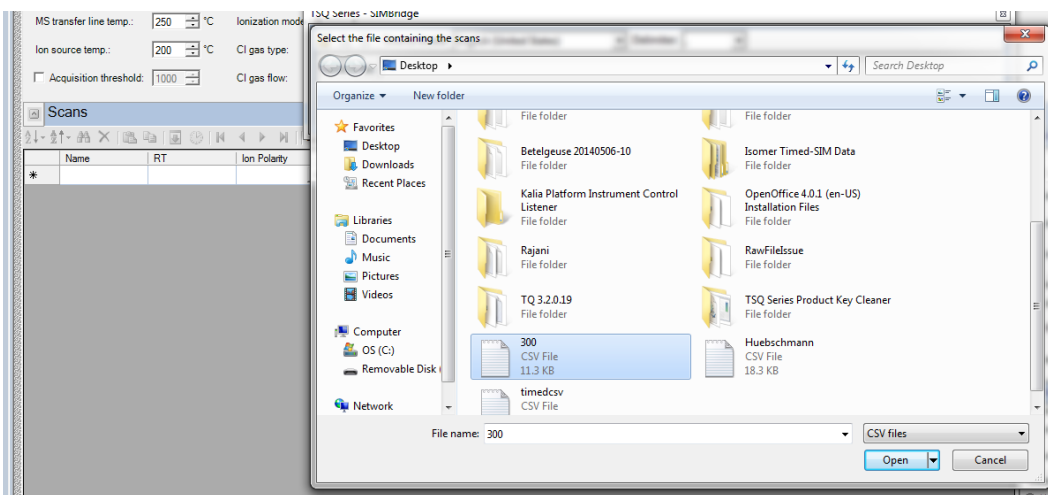
- After clicking **Link to External File**, the **SIMBridge** dialog box opens. Choose the language of your method file from the **Source Locale** drop-down menu. See [Figure 83](#).

**Figure 83.** Setting the Source Language of Method Files using SIMBridge



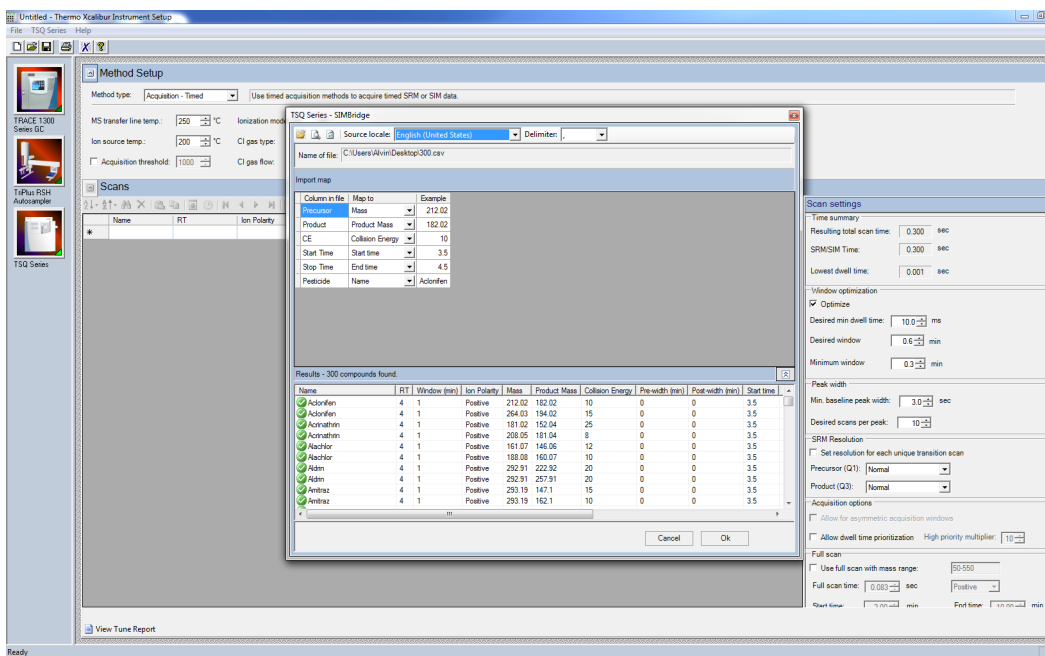
c. Browse to your file. See [Figure 84](#).

**Figure 84.** Linking to an External File using SIM Bridge



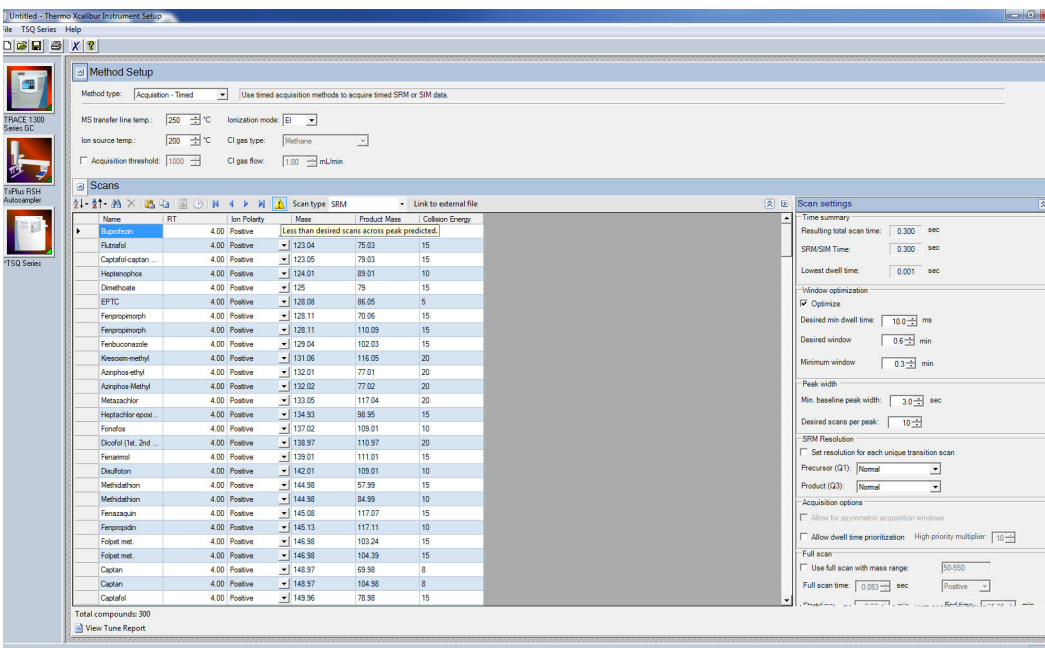
- d. Click **Open** to open the method in SIMBridge.
- e. If necessary, change the method headings in your original file to match those in the method editor. A green check mark appears when your method is validated. See [Figure 85](#).

Figure 85. Changing Method Headings in SIMBridge



f. Click **Open** and the external method will be opened in the method editor. See Figure 86.

Figure 86. Viewing a Linked File in the Method Editor

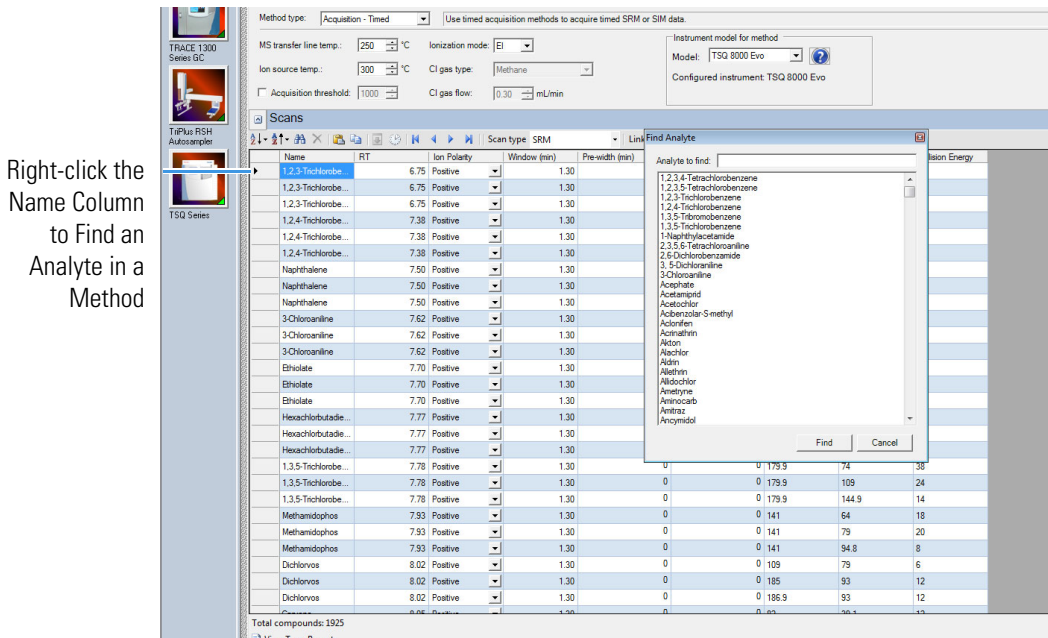


g. If you open an older model TSQ 8000, TSQ 8000 Evo, TSQ Duo, or a TSQ 9610 (if you have a TSQ 8000 Evo system) method, the **Instrument Model for Method** box appears.



- h. Select your model from the drop-down menu in **Instrument Model for Method** in order to make the imported method compatible with your model.
- i. In the **Name** column, enter the analyte name. If you have linked to an external file, the analyte name located in the first column of your linked file will appear in the first cell in the Name column. Right-click this window to search for an analyte within your method. See [Figure 87](#). This function is useful if you need to edit an analyte in a complex method.

**Figure 87.** Finding an Analyte in a Method



- j. In the **RT** column, enter retention times for SRM methods. The retention time is the time it takes an analyte to pass from the column inlet to the detector.
- k. In the **Window (min)** column, set the acquisition times. Smaller acquisition windows increase sensitivity but can cause you to miss your peak if set too small. Changing the window size only affects sensitivity if it reduces the number of compounds analyzed in a segment. If the windows do not overlap, you will not notice an improvement by reducing the acquisition window.

**Note** The Window (min) column does not appear by default. The Method Editor displays it only when the window optimizer is not active.

- l. In the **Mass** column, enter the precursor ion mass for SRM methods. For SIM methods, enter the mass of the ion you wish to monitor.
- m. In the **Product Mass** column, enter the product ion mass (for SRM methods). The product ion mass is the result of fragmenting the precursor ion with collision gas.
- n. In the **Collision Energy** column, enter the collision energy (for SRM methods) in eV. The collision of a precursor ion with the collision gas at a particular energy fragments the precursor ions into product ions. By varying the collision energy, a

## 4 Creating a Method

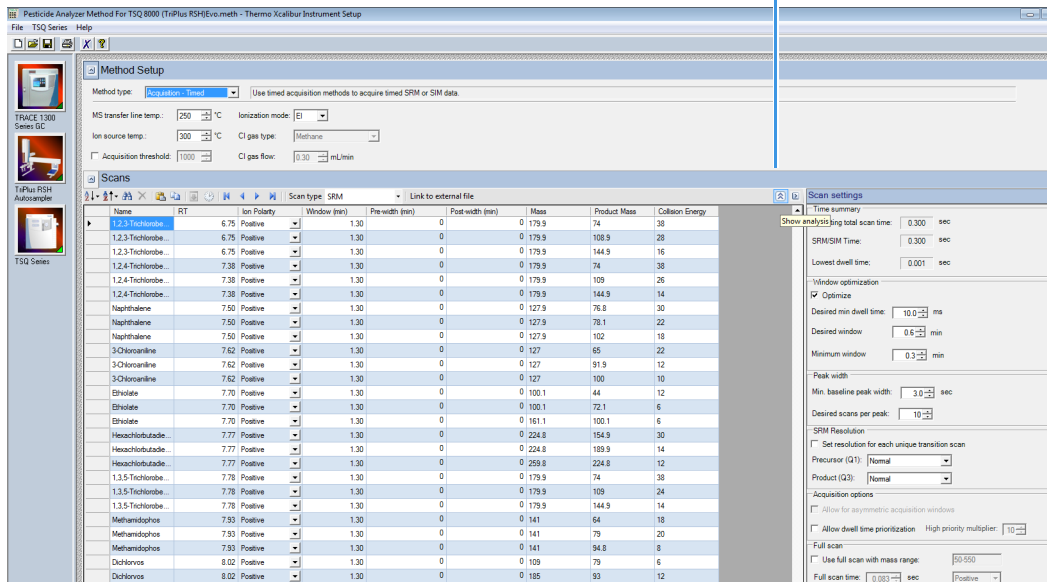
Creating a GC-MS Method in Xcalibur Software

single precursor ion can be fragmented into several product ions. An SRM transition is defined by a precursor ion being fragmented into a particular product ion mass using a certain collision energy.

- o. Use the **Ion Polarity** column if you are using CI mode to tell the instrument to generate positive or negative ions. Only use this column if you are using CI mode. In EI mode, this column should always be set to **Positive**.
- p. Click the **Show Analysis** arrow (see [Figure 88](#)) to validate your method. A chart appears with all your analytes by name and in order of their retention times. See [Figure 89](#).

**Figure 88.** Accessing the Show Analysis Feature

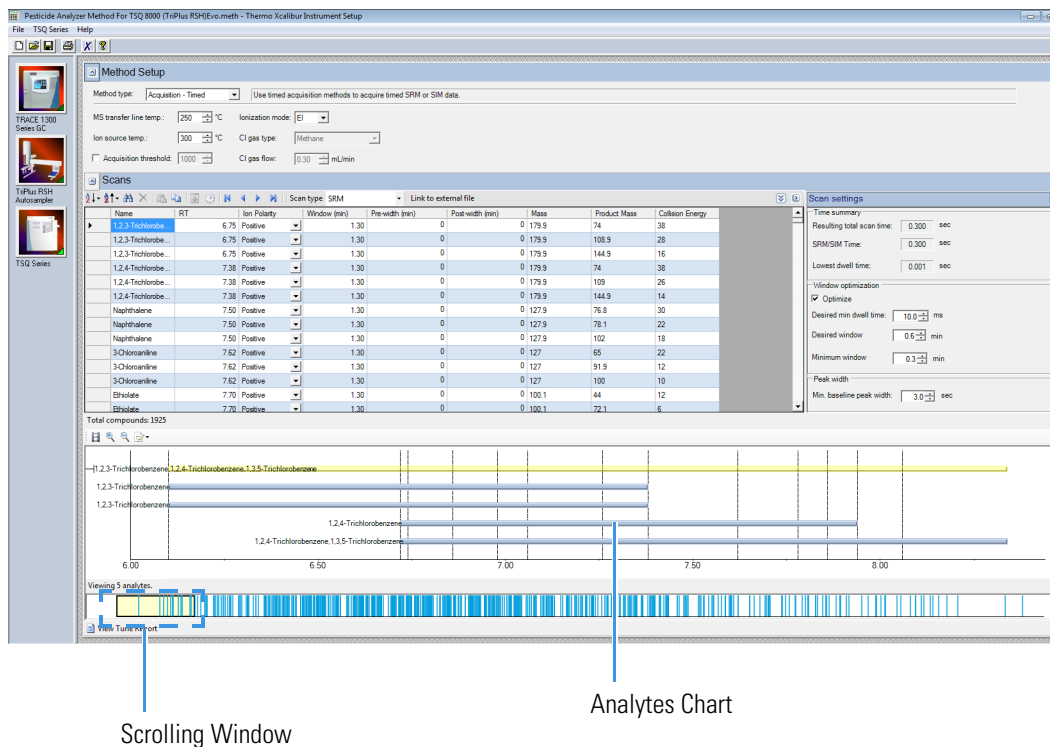
Show Analysis  
Button



The screenshot displays the 'Method Setup' window in Xcalibur software. The 'Scans' table is the central focus, listing various analytes with their retention times, ion polarities, and SRM parameters. A 'Show Analysis' button is highlighted in the top right corner of the Scans table.

Name	RT	Ion Polarity	Window (m)	Pre-width (min)	Post-width (min)	Mass	Product Mass	Collision Energy
None	6.75	Positive	1.30	0	0	179.9	74	38
1,2,3-Trichlorob...	6.75	Positive	1.30	0	0	179.9	108.9	28
1,2,3-Trichlorob...	6.75	Positive	1.30	0	0	179.9	144.9	16
1,2,4-Trichlorob...	7.38	Positive	1.30	0	0	179.9	74	38
1,2,4-Trichlorob...	7.38	Positive	1.30	0	0	179.9	109	26
1,2,4-Trichlorob...	7.38	Positive	1.30	0	0	179.9	144.9	14
Naphthalene	7.50	Positive	1.30	0	0	127.9	76.8	30
Naphthalene	7.50	Positive	1.30	0	0	127.9	78.1	22
Naphthalene	7.50	Positive	1.30	0	0	127.9	102	18
3-Chloroaniline	7.62	Positive	1.30	0	0	127	65	22
3-Chloroaniline	7.62	Positive	1.30	0	0	127	91.9	12
3-Chloroaniline	7.62	Positive	1.30	0	0	127	100	10
Etholate	7.70	Positive	1.30	0	0	100.1	44	12
Etholate	7.70	Positive	1.30	0	0	100.1	72.1	6
Etholate	7.70	Positive	1.30	0	0	161.1	100.1	6
Hezochlorozada...	7.77	Positive	1.30	0	0	224.8	154.9	30
Hezochlorozada...	7.77	Positive	1.30	0	0	224.8	189.9	14
Hezochlorozada...	7.77	Positive	1.30	0	0	259.8	224.8	12
1,3,5-Trichlorob...	7.78	Positive	1.30	0	0	179.9	74	38
1,3,5-Trichlorob...	7.78	Positive	1.30	0	0	179.9	109	24
1,3,5-Trichlorob...	7.78	Positive	1.30	0	0	179.9	144.9	14
Methamidophos	7.93	Positive	1.30	0	0	141	64	18
Methamidophos	7.93	Positive	1.30	0	0	141	79	20
Methamidophos	7.93	Positive	1.30	0	0	141	94.8	6
Dichlorvos	8.02	Positive	1.30	0	0	109	79	6
Dichlorvos	8.02	Positive	1.30	0	0	185	93	12

Figure 89. Validating a Method



- q. Use the scrolling window at the bottom of the screen to view all your analytes' expected retention times. Resize the window to view more analytes by dragging one side of the window out. As the scrolling window is decreased in size, fewer analytes are shown in the analytes chart. Increasing the size of the scrolling window allows you to view more analytes in your method. If the number of analytes retention times being viewed exceeds 50, an evenly spaced sample of the analytes shows through the window.

You may also click the ladder icon walk your analytes: have the software automatically run through your list of analytes. Click the ladder icon again to stop the process at any time.

- r. Open the options menu to select the information you want made available in the analytes window.

Figure 90. Choosing Display Options for Analytes

The screenshot shows the Xcalibur software interface. On the left, there are icons for the TRACE 1300 Series GC, TriPlus RSH Autosampler, and TSQ Series. The main panel displays the 'Scans' table with columns for Name, RT, Ion Polarity, Window (min), and Pre-width (min). Below the table, a context menu is open, showing options: 'Show segment lines' (checked), 'Show segment numbers', 'Show compound names' (checked), and 'Reset zoom to default'. The chromatogram below the menu shows peaks for 1,2,3-Trichlorobenzene, 1,2,4-Trichlorobenzene, and 1,2,4-Trichlorobenzene, 1,3,5-Trichlorobenzene. A label 'Analytes Display Options' points to the context menu.

Name	RT	Ion Polarity	Window (min)	Pre-width (min)
1,2,3-Trichlorobe...	6.75	Positive	1.30	0
1,2,3-Trichlorobe...	6.75	Positive	1.30	0
1,2,3-Trichlorobe...	6.75	Positive	1.30	0
1,2,4-Trichlorobe...	7.38	Positive	1.30	0
1,2,4-Trichlorobe...	7.38	Positive	1.30	0
1,2,4-Trichlorobe...	7.38	Positive	1.30	0
Naphthalene	7.50	Positive	1.30	0
Naphthalene	7.50	Positive	1.30	0
Naphthalene	7.50	Positive	1.30	0
3-Chloroaniline	7.62	Positive	1.30	0
3-Chloroaniline	7.62	Positive	1.30	0
3-Chloroaniline	7.62	Positive	1.30	0
Ethiolate	7.70	Positive	1.30	0
Ethiolate	7.70	Positive	1.30	0

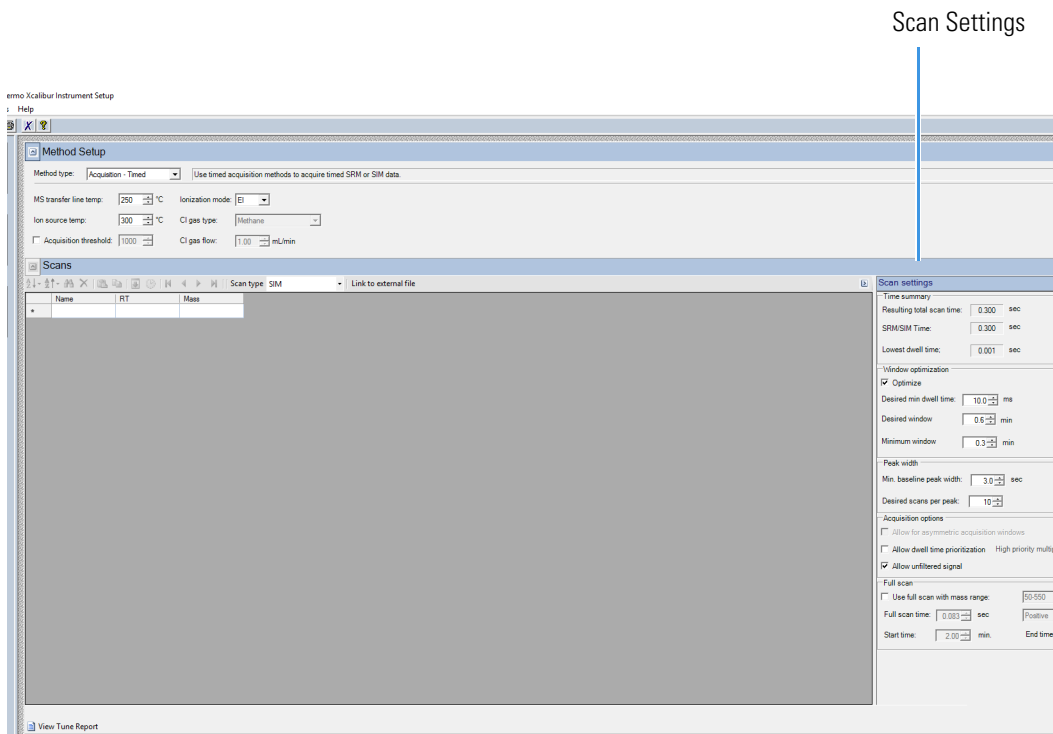
Total compounds: 1925

Viewing 5 analytes.

**Tip** If your SRM or SIM windows are too congested to achieve the total scan time at the minimum dwell time, the event will be highlighted in orange or red. The orange warning indicates that you might get fewer scans across the peak than you want. The red error indicates that the instrument cannot complete the scans in the time allotted in your method. To correct this, reduce the desired scans across the peak, reduce the acquisition windows, or reduce the minimum dwell time to correct.

6. Use the right-side panel in **Timed Mode** mode to make the following adjustments to your method.
  - a. Use the **Scan Settings** panel to adjust the following settings. See [Figure 91](#) on [page 95](#).

Figure 91. Timed Mode Scan Settings



- i. The **Window Optimization** pane allows access to the window optimizer settings. When the optimize button is checked, acquisition windows will be set automatically based on the acquisition window and dwell time targets set in this pane. For complex SRM or SIM methods, such as a method containing more than three hundred SRM transitions, this option will help ensure a method is created that can achieve the requested scans per peak.

Algorithm Details: If the **Optimize** checkbox is checked, the SRM acquisition windows in the method are set to the **Desired Window** unless the **Desired Min Dwell Time** cannot be met with the number of **Requested Scans Per Peak**. If this occurs, then the acquisition windows are reduced until either the **Desired Min Dwell Time** is met, or the **Minimum Window** is reached. If the **Minimum Window** is reached first, the **Minimum Dwell Time** is reduced until the **Requested Scans Per Peak** is achievable. If the absolute minimum dwell time on the instrument, which is 0.5 ms, is reached before the requested points across the peak are achieved, the **Minimum Window** is lowered until the **Desired Scans Per Peak** criteria are met or until the absolute allowed minimum window on the instrument is reached, which is 0.24 min. In this very rare case you must reduce the number of **Desired Scans Per Peak**, increase the **Min Baseline Peak Width**, or reduce the number of transitions contained in your method before you will be allowed to save your method (see [Chapter 8, “Troubleshooting.”](#)).

Settings: **Optimize** is checked by default. When Optimize is checked, you can adjust the settings in the pane to optimize your method. See [Figure 91](#) on [page 95](#). Remove the check from the box if you want to manually input your acquisition windows. The default values for the window optimizer should give reasonable results for normal methods. The default values are:

Desired Min Dwell Time—10 ms

Desired Window—0.6 min

Minimum Window—0.3 min

- Change the minimum dwell time using the **Desired Min Dwell Time** combo box. If your method has many transitions, you may want to reduce the desired minimum dwell time. Note that the wider the acquisition windows in your method, the shorter the average dwell time will be.
- Change the desired acquisition window in the **Desired Window** combo box. The desired window is the amount of time to scan for a transition around a given retention time to ensure that compound will be observed. The desired window can be set from 0.24–5 min. Set the window wide enough so that a retention time shift will not cause you to miss any compounds. Include extra time in this window if there is any uncertainty in compound retention times in the method. Note that the longer the dwell time for your compounds, the narrower your acquisition windows will be.
- Change the minimum acquisition window in the **Minimum Window** combo box. The minimum window can be set from 0.24–5 min. This is the smallest amount of time that should be scanned for a transition around a given retention time so that you are confident the compound will be observed. Set the minimum window to the lowest safe value to prevent compound retention times from drifting outside the acquisition window.

**Note** If the dwell time limit is reached and the minimum acceptable window is forced below the 0.24 min limit, the method will fail, and a smaller list must be used.

- ii. The **Time Summary** section reports the resulting total scan time, the SRM/SIM time, and lowest dwell time for you method. These values are for information only and not editable.
  - The **Resulting Total Scan Time** is the baseline peak width divided by the number of points desired across the peak. These values should be updated if your method requirements are different from the defaults.
  - The **SIM/SRM** time is the total length of all SIM or SRM scans for each compound in your list. This will match the total scan time unless the method also has a full scan event.

- The **Lowest Dwell Time** is the actual lowest dwell time achieved by the method settings. When the **Optimize** check box is selected, if the actual lowest dwell time is considerably lower than the requested dwell time, then the minimum window has been reached, and if the actual lowest dwell time is considerably higher than the requested dwell time, then the requested window has been reached.
- iii. Under **Peak Width**, you can change the minimum baseline peak width and desired scans per peak. These values are used to calculate the SRM/SIM Time. The minimum baseline peak width should be set roughly to the shortest chromatographic peak time in your analysis.
- iv. Under **SRM Resolution**, check the **Set Resolution for Each Unique Transition Scan** checkbox if you want to adjust the Precursor (Q1) Resolution or Product (Q3) Resolution for individual analytes. If this box is not checked, the settings apply to all compounds in the method.
  - Use the **Precursor (Q1) Resolution** column to set the full width at 50% (FWHM) of the precursor mass for SRM scans. The combo-box options are **Normal**, **Wide (1.5 FWHM)**, **Widest (2.5 FWHM)**, or **Custom**. for each scan after a precursor mass has been entered. The default setting is Normal, which uses the tuned resolution values from the tune file specified in the **Tune File Name** column. Opening the precursor peak width increases the ion signal into the collision cell, which might improve the sensitivity of your method; however, it may also increase the background noise level. Set Custom width in the tune types. If using the default tune types, Custom width is 1.2 FWHM.
  - Use the **Product (Q3) Resolution** column to set the full width at 50% (FWHM) of the product mass for SRM scans. The combo box options are **Normal**, **Wide (1.5 FWHM)**, **Widest (2.5 FWHM)**, or **Custom** for each scan after a product mass has been entered. If the product mass is removed from a scan to run a SIM or FS scan event, the Product (Q3) Resolution column returns to the default value of Normal, which uses the tuned peak width at 10% or 50% as specified in the Tune File Name column. Selecting Wide (1.5 FWHM) or Widest (2.5 FWHM) increases the product ion peak width to 1.5 and 2.5 amu FWHM respectively, resulting in an increase of ions reaching the detector. The increase in ions at the detector may improve the sensitivity of your method; however, it may also increase the background noise level, as well as introduce isotopic interference from +/- 1 amu ions. Set Custom width in the tune types. If using the default tune types, Custom width is 1.2 FWHM.

**Note** To achieve the highest transition speeds capable on the instrument, the resolution of all transitions must be set to Wide or Widest for both Q1 and Q3 resolution.

**Note** When the window optimizer is activated the **Window**, **Pre-width**, and **Post-width** columns are no longer available in the compound list editor. If your method is linked to a file or imported from a file with values in these columns, the values are stored in memory and can be recovered by deactivating the window optimizer.

- v. Under **Acquisition Options**, select the **Allow for Asymmetric Acquisitions** check box to add extra time to the beginning or end of an acquisition window without affecting other timing in your scan. When you select this option, **Pre-width and Post-width** columns are added to your method. Enter the extra times in these columns.

**Note** This option is only available when the method optimizer is not active.

Select the **Allow Dwell Time Prioritization** check box to increase the dwell times for selected scans. The choices for each scan are **Normal** or **High**. Giving a scan high priority increases its dwell time by the value you set in the **High Priority Multiplier** box.

Select **Allow Unfiltered Signal** for most methods. To improve integration of congeners, the box must be checked. Leaving the box unchecked helps improve the signal-to-noise ratio for resolved chromatographic peaks.

- vi. Under **Full Scan**, you indicate if a Full Scan is to be run along with SIM and SRM. The Mass Range, Scan Time, Start and End Time can be set after the **Use Full Scan** box is checked. The full scan time will reduce the SRM/SIM time without increasing the total scan time. If you only want to use full scan for part of your method, you can enter full-scan start and end times.

**Tip** Click the arrow at the top right of the **Scan Settings** panel to collapse or expand the panel.

- b. Use the options in the **Instrument Settings** panel to further adjust your method.
  - i. Use **Tune File** to select a tune file or files to be used for this scan. If you are using EI, only the **Tune File(+)** pull-down menu is available. If you are using negative CI, select a tune file from the **Tune File(-)** pull-down menu. Choose **AutoTune\_NCI** to use the most recent negative CI automatic tune file you created in [Chapter 3, "Tuning."](#) If you are using positive CI, select a tune file from the **Tune File(+)** pull-down menu. Choose **AutoTune\_PCI** to use the most recent positive CI automatic tune file you created in [Chapter 3, "Tuning."](#) The software defaults to the most recent **AutoTune\_NCI** or **AutoTune\_PCI** tune file you created.
  - ii. In the **Detector Gain** area, set the detector gain. Select the **Use Last Tuned Detector Gain** option to indicate that you want to use the detector gain set in Auto Tune. If you do not need to use the gain set in Auto Tune, then you can set the gain manually. Higher gains give larger signals, but may shorten the lifetime of the detector when concentrated samples are detected. To manually set the

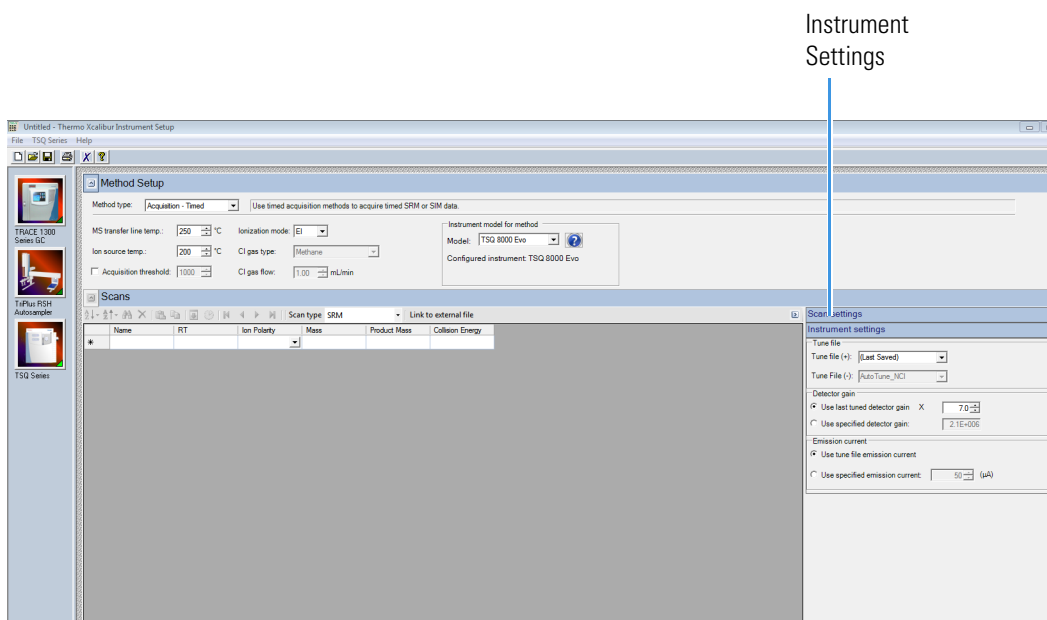


detector gain, select the **Use Specified Detector Gain** radio button and enter the desired value in the Detector gain box.

- iii. Use the **Emission Current** box to set the emission current used during the acquisition. For optimal analytical performance and stability, use the emission current at which the system was tuned. However, if you want to use a different emission current, select the **Use Specified Emission Current** radio button and enter a value in the **Emission Current ( $\mu\text{A}$ )** box. A high emission current will lead to the production of more ions, but the interaction of too many ions in the source can cause a degradation in the resolution and signal. The margin of error is  $\pm 0.5 \mu\text{A}$ .

**Tip** Click the arrow at the top right of the **Instrument Settings** panel to collapse or expand the panel.

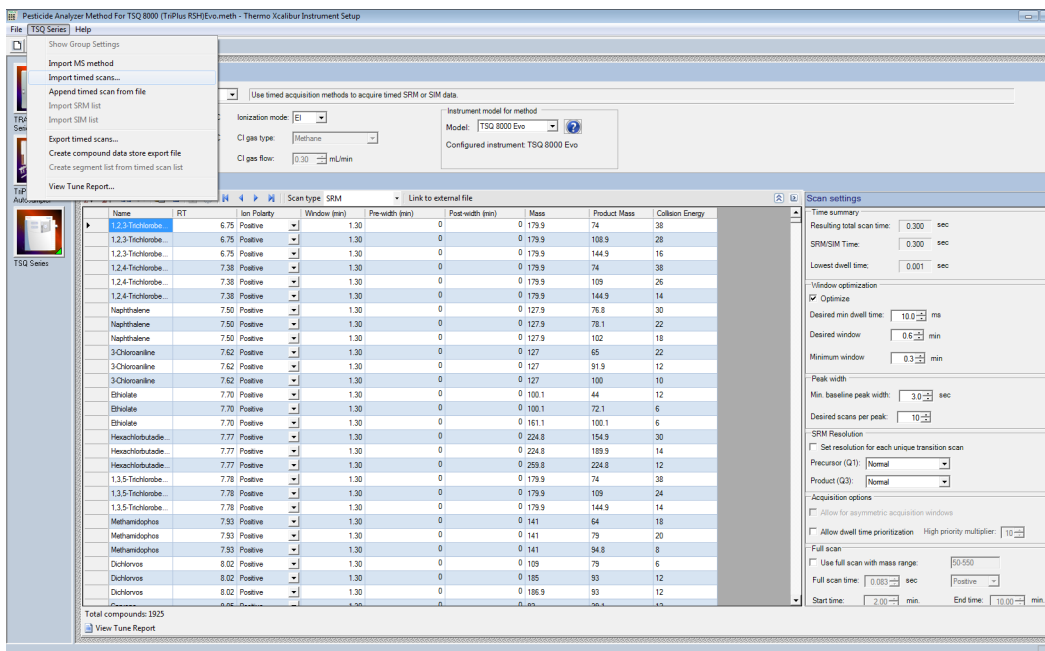
**Figure 92.** Timed Mode Instrument Settings



7. To import a Thermo Scientific™ ISQ™ Series or TSQ Quantum™ Series MS method, choose **TSQ Series | Import MS Method**. See [Figure 93](#).

**Note** This will only import the MS part of the method. You must set the GC and autosampler parameters.

**Figure 93.** Importing Methods

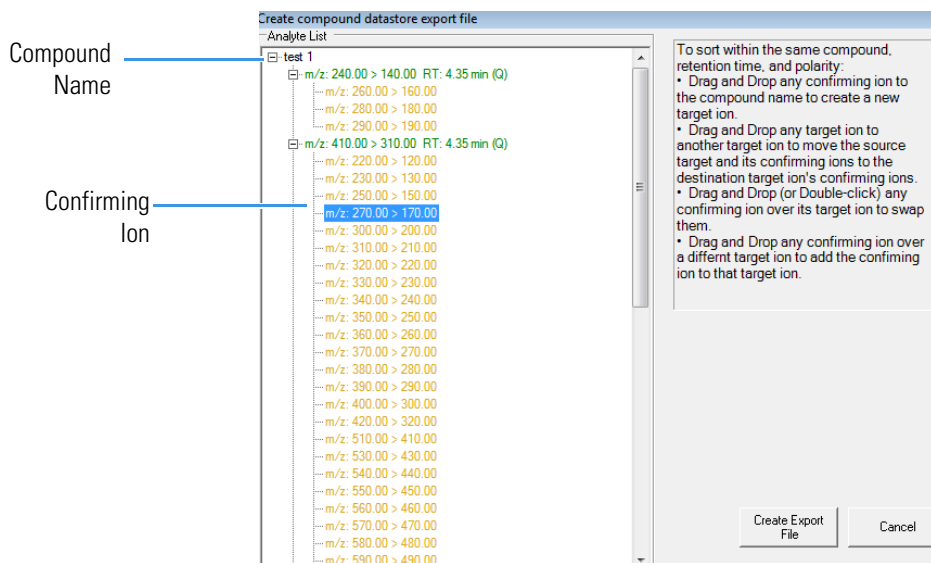


8. Choose **TSQ Series | Import Timed Scans** to import .csv or .xml files of previous methods or from AutoSRM. The software will only load files in valid formats.

**Tip** Export a timed scan list to see an example of a valid format.

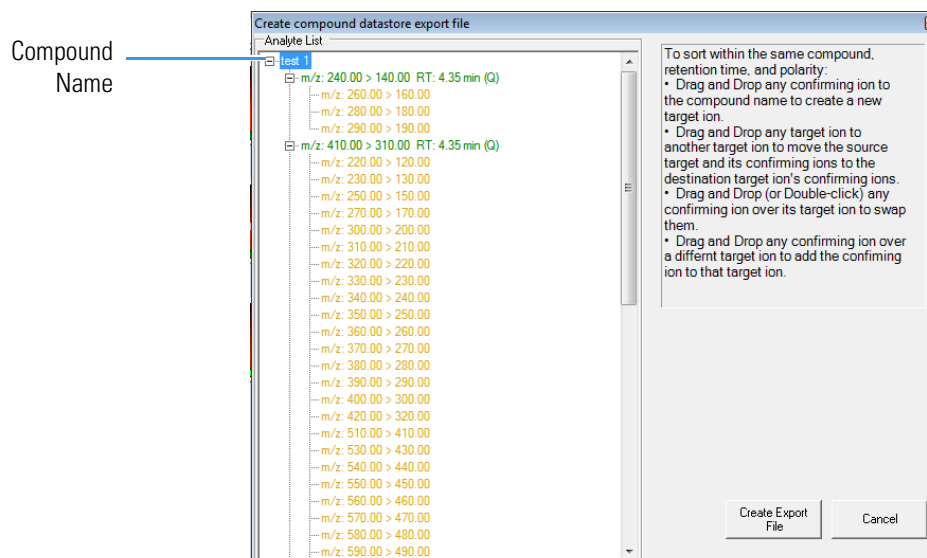
9. Choose **TSQ Series | Append Timed Scan from File** to add scans from previous methods to the end of your open scan list. As above, you may import .csv or .xml files.
10. Choose **TSQ Series | Export Timed Scans** to export your method as a .csv file. If you prefer editing your methods in spreadsheet applications, you may want to use this option.
11. Choose **TSQ Series | Create Compound Data Store Export File** to prepare your file for the compound database in the TraceFinder application.
  - a. To create a new target ion from the list of confirming ions with identical retention times for a compound, select the confirming ion of interest.

**Figure 94.** Creating a New Target Ion



- b. Drag the confirming ion to the compound name at the top of the list.

**Figure 95.** Moving the Confirming Ion to the Compound Name

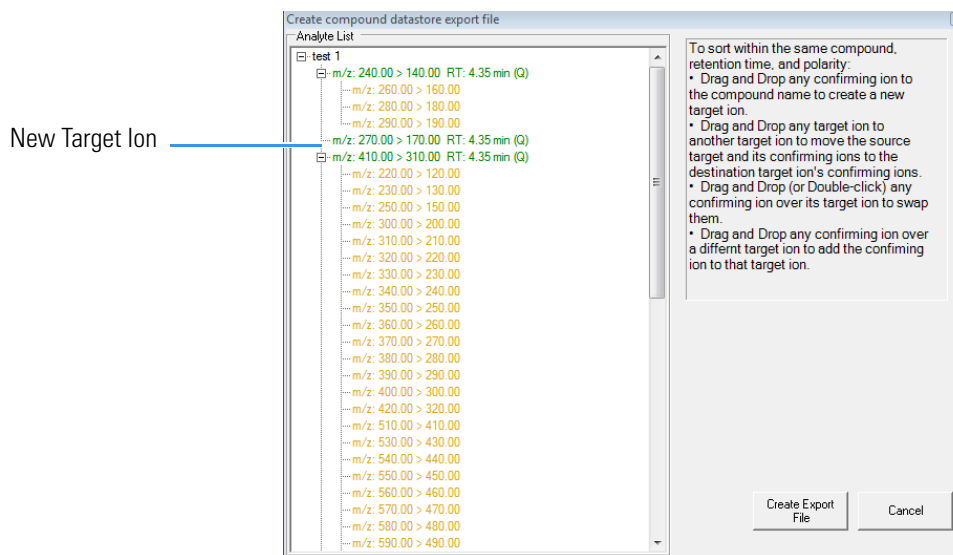


- c. The confirming ion now appears in the list as a target ion. See [Figure 96](#).

## 4 Creating a Method

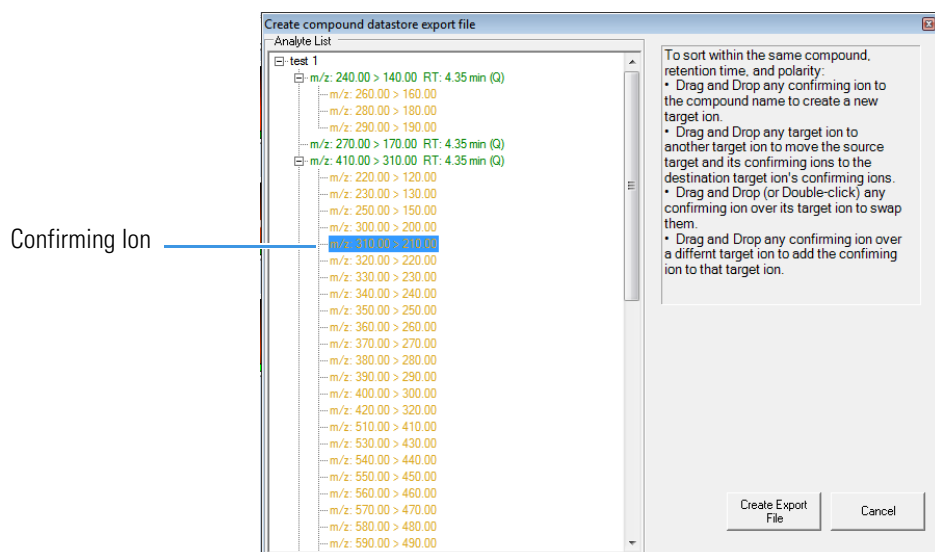
Creating a GC-MS Method in Xcalibur Software

**Figure 96.** Locating the New Target Ion



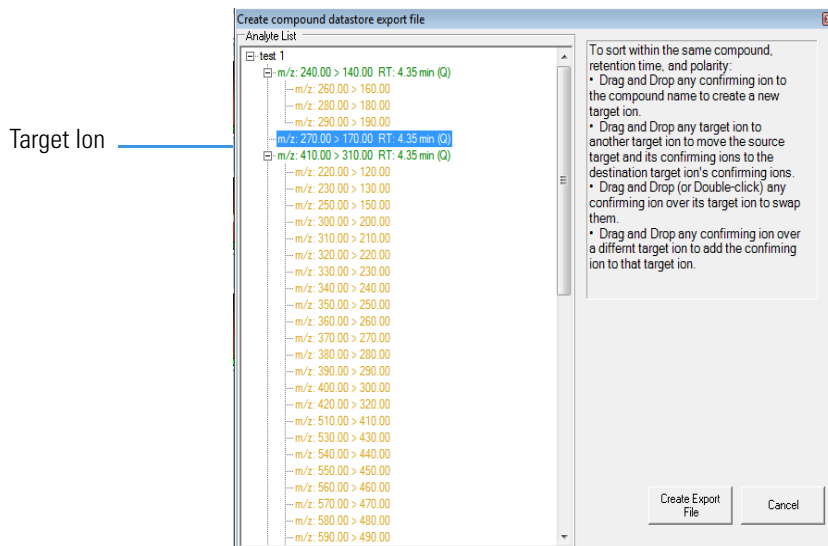
- d. To add a new confirming ion to a target ion in the list, select the confirming ion of interest. See [Figure 97](#).

**Figure 97.** Adding a New Confirming Ion to a Target Ion



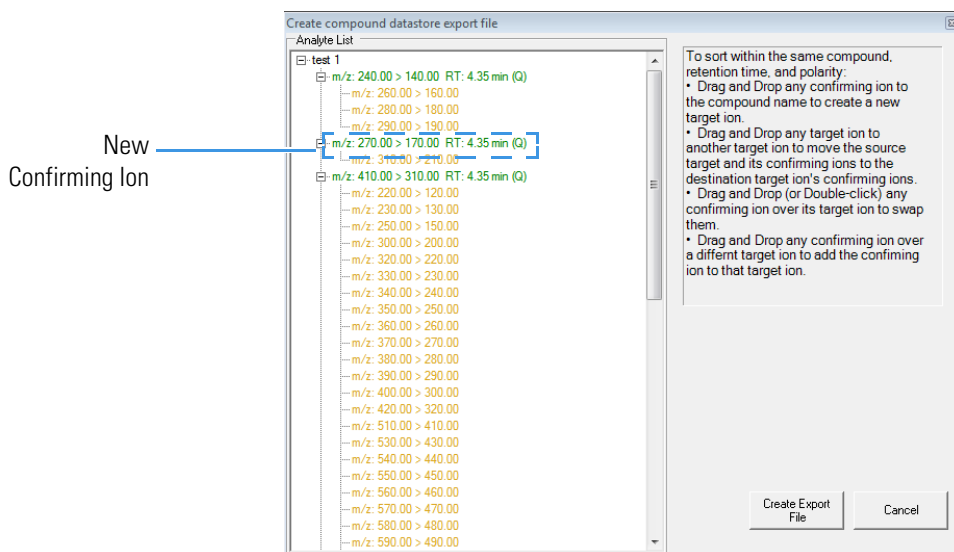
- e. Drag the confirming ion under the target ion of interest. See [Figure 98](#).

**Figure 98.** Moving the Confirming Ion to the Target Ion of Interest



f. The confirming ion appears in the list under the selected target ion. See [Figure 99](#).

**Figure 99.** Locating the New Confirming Ion



g. Click **Create Export File** when you are through creating your ion list to export the list to the TraceFinder software compound database.

12. Choose **TSQ Series | Create Segment List From Timed Scan List** to import a general acquisition method.
13. Choose **TSQ Series | View Tune Report** to view the latest tune report the method will use. Choose **Report Options** to open the Report Options dialog box (see [Figure 100](#)) and add identifying information to the tune report.

## 4 Creating a Method

Creating a GC-MS Method in Xcalibur Software

**Figure 100.** Configuring the Tune Report Options

The screenshot shows the Xcalibur software interface. At the top, it displays tune information: "Tune Completed - Fri Jan 6 15:21:29 2012", "Tune File: Leak\_EI\_2012-01-06-15-21-29.tsq@Tune", "Tune Type: Leak Check", and "Starting Tune File: (Last Saved Tune)". On the right, it shows "Instrument ID: 1011152" and "User: Alvin".

The main area contains a mass spectrum plot on the left and a table of mass data on the right. The mass data table is as follows:

m/z	Int.	FWHM
69.07	21,951,688	0.69
131.07	27,109,123	0.69
219.00	27,358,390	0.67
414.00	1,286,150	0.56
502.00	1,205,737	0.50

Below the mass data table is an "Air/Water Check" section with the following data:

	(%32/69)	
O2	4.22	
CO2	0.54	
N2 / H2O	2.40	

On the right side of the interface, there is a list of instrument parameters:

- Electron Lens Voltage: 15 V
- Electron Energy: 70 eV
- Emission Current: 50  $\mu$ A
- Ion Guide Frequency: 1593.6
- Q1 Frequency: 1095.3
- 1888.9
- 1088.9
- 1390.7 V
- $1.5 \times 10^{-5}$
- 250.0 °C
- 1
- 200.0 °C
- 76 mTorr
- $1.0 \times 10^{-5}$  Torr

The "Report Options" dialog box is open in the center. It contains the following fields and options:

- Lab name: [Text Field]
- Instrument name: [Text Field]
- Calc relative abundance using: [69] (dropdown menu)
- Include signature line
- Optional reports:  Diagnostics,  Device settings
- Custom report:  Use custom report definition
- File name: [Text Field]

Buttons for "OK" and "Cancel" are visible. At the bottom of the dialog, there are fields for "Signature:" and "Date:".

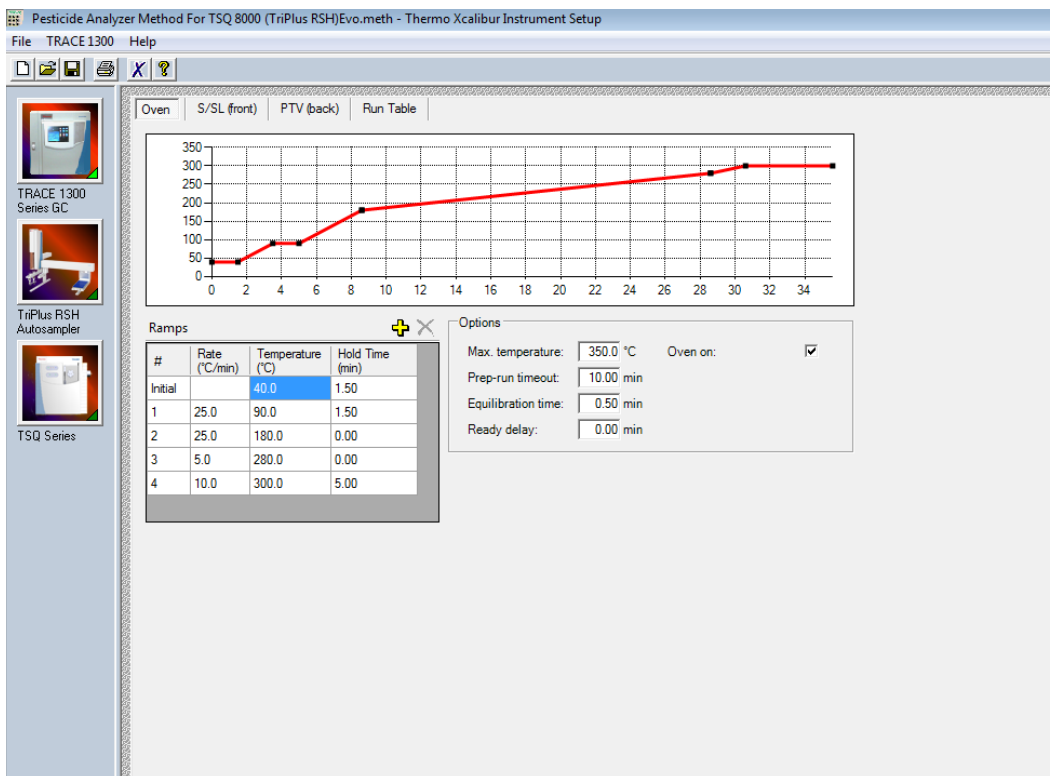
## Creating a GC Method in Xcalibur Software

You can create a method for the TRACE 1600/1610 Series GC from the Method Editor window.

### ❖ To create a method for the TRACE 1600/1610 Series GC

1. Click the GC icon in the left pane.
2. Click the **Oven** tab to set the oven temperatures. See [Figure 101](#). There is always at least one temperature and time in any GC temperature program. In the Initial row, enter the initial temperature, which must be 4 °C (7 °F) above room temperature and less than the maximum operating temperature of your GC column. If you set the initial temperature to a value below this limit, the GC will not reach the initial temperature. If you set the temperature above the limit, the GC column will be damaged. You can set the initial hold time to a value between 0 and 999.99 minutes. The typical initial temperature is at least 10 °C (18 °F) above the boiling point of your sample solvent, and the initial time is usually long enough for the solvent to move through the column.

Figure 101. GC Oven Settings



3. Select a maximum of 32 temperature ramps, each with its own ramp rate, final temperature, and hold time. Each temperature ramp begins at the previous ramp's temperature after the hold time has expired. A typical program has one or two ramps. The GC temperature profile is the primary method for separating your analytes from each other, the solvent, and the matrix. Your temperature profile must be optimized for your analysis needs.
4. You can also select the maximum allowed oven temperature, which should be set to the maximum temperature allowed by your method, *not* the maximum allowed by your column. The maximum temperature allowed by the GC is 450 °C.
5. Select the prep-run timeout. The prep-run timeout is the maximum amount of time that the GC will wait before it gives up on an injection. As an example, with the default value of 10 minutes, if the GC is ready to receive an injection, but does not receive it after ten minutes, the GC will stop waiting. This usually occurs in case of an error.
6. Set the equilibration time. The equilibration time is a delay between when the GC is at temperature and when the GC reports as being ready. The equilibration time is typically set to 0.5 minutes.



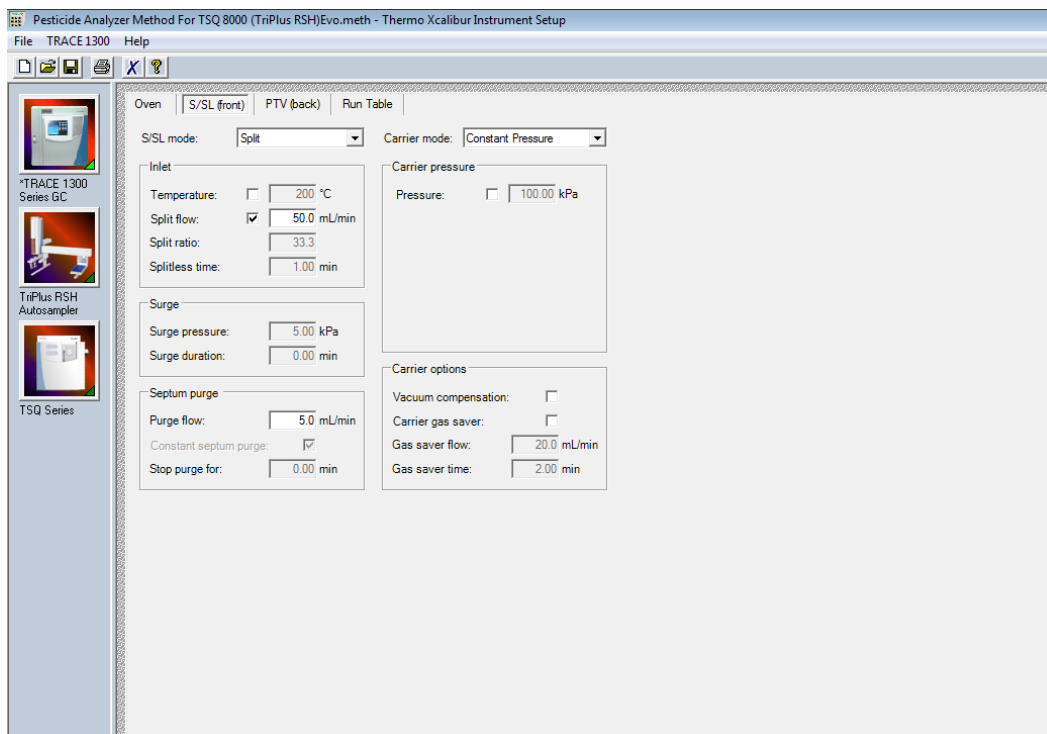
**CAUTION INSTRUMENT DAMAGE.** Be sure not to overheat the GC column or it may contaminate the instrument.



**ATTENTION DOMMAGES À L'INSTRUMENT.** Assurez-vous de ne pas surchauffer la colonne CG ou elle pourrait contaminer l'instrument.

7. (Optional) Enable the cryogenic option to cool the oven. If this option is selected, then the minimum allowed temperature in a temperature ramp will fall from 0 to -99 °C (32 to -146 °F). The GC also allows the use of a post-run column cleaning. This is not typically used because the material that is purged from the column in this step would go into the TSQ 9610 MS, which can lead to contamination. If you want to use this feature, set the GC oven temperature, as well as the amount of time to remain at that temperature after the analytical run is complete. You can also set the amount of pressure used to push the carrier gas through the column. Refer to the *TRACE 1600/1610 Series GC User Guide* for more information.
8. If you have a split/splitless inlet (SSL) injector, click the **S/SL-Front** or **S/SL-Back** tab to configure the injector port settings. In the inlet area, do the following:
  - a. Select the **Temperature** check box and set the temperature to at least 10 °C (18 °F) lower than the boiling point of your least volatile analyte for a splitless injection. The material should be injected into the port to vaporize and move into the GC column quickly. Higher temperatures can lead to thermal decomposition of some analytes, so you must optimize the injector temperature for your analysis. The SSL temperature can be set up to 400 °C (752 °F). A typical value would be 250 °C (F).

**Figure 102.** Configuring the Injector Port Settings on the GC





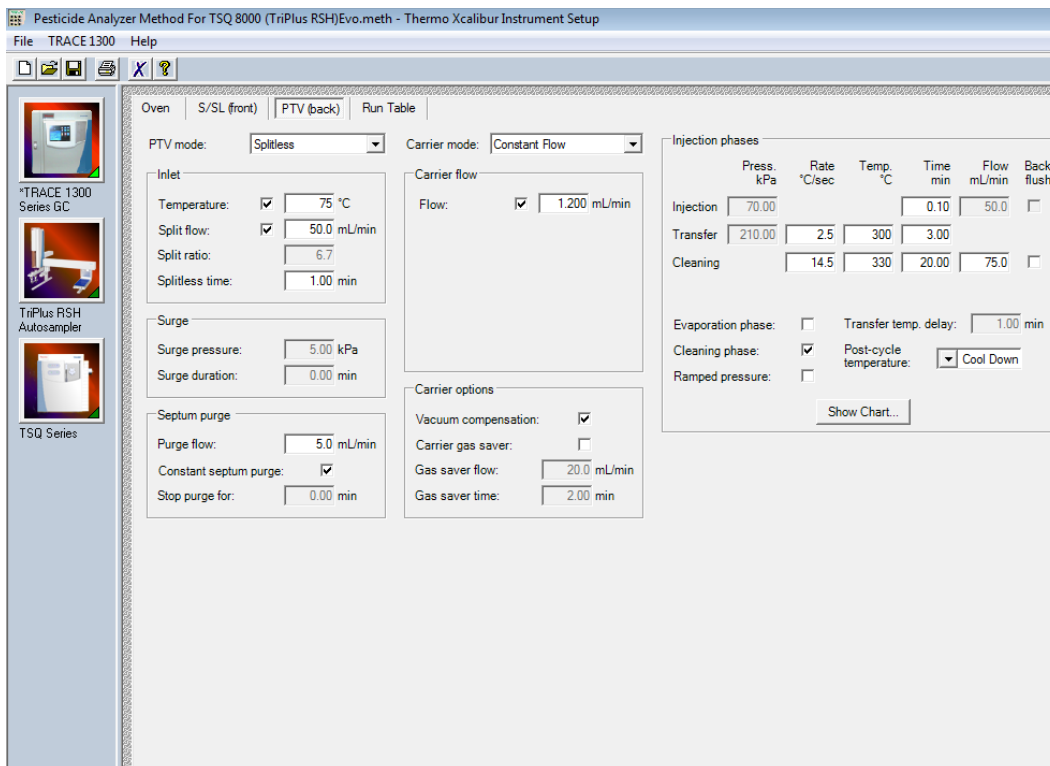
- b. Select the **Split Flow** check box to dilute high concentrations of sample. The split flow is the amount of gas that is swept through the injector to the exhaust port. Higher values will give more dilution. The split flow reduces the amount of contamination that builds up in your system. The split flow ratio is the ratio of the split flow to the carrier gas flow. It is effectively the dilution ratio of the sample. This setting is typically turned on and set to a flow of 50 mL/min. However, more carrier gas is used, so for your analysis, lower split flows may be more acceptable. If you set the split ratio, the software calculates the correct split flow. The reverse is true also.
- c. For best results, use the septum purge, which means additional carrier gas will go through the injector. The default purge flow value is 5 mL/min. This reduces the buildup of contaminants in the injector, on the column, and in the TSQ 9610 instrument. If you perform a splitless injection, even if the split flow is set, the split flow turns off for the splitless time. The septum purge turns off for the stop purge time. After these times, the split flow and septum purge are reactivated.
- d. Set the carrier mode to **Constant Flow, Constant Pressure, Programmed Flow, or Programmed Pressure**. The gas flow and the oven temperature work together to determine how well the analytes are separated and how long the analysis will take. If you use constant pressure, as the column is heated in the oven, the flow rate will fall as the viscosity of the carrier gas increases. If you use constant flow, the carrier gas pressure will increase as the column temperature increases to keep the flow constant. Constant flow is more common. Typical flow rates are 1-3 mL/min. The pressure depends on the column length and internal dimensions, so there is not a typical value. Because the outlet of the column is in the TSQ 9610 instrument, which is under vacuum, be sure the vacuum compensation is on to ensure accurate flow rates. It is recommended to use the same carrier gas flow in the method that is used during tuning of the mass spectrometer.
- e. (Optional) Under Carrier Pressure, select the check box to use programmed flow or programmed pressure modes. In these modes, you may have up to three flow rates or pressures to use during an analytical run. This feature is not commonly used, but may be necessary if you have a particularly challenging separation.
- f. In an effort to reduce the amount of carrier gas used, select the **Carrier Gas Saver** option under Carrier Gas Options. When used, the split flow is reduced to the gas saver flow after the gas saver time. It is not recommended to use a flow of less than 20 mL/min because contaminants can build up in the injector, column, and TSQ 9610 instrument, which can affect the system performance.
- g. Finally, if your analysis requires a higher flow to quickly sweep the analytes into the column, which may be needed with high temperature injectors and thermally labile compounds, use the surge pressure to increase the column flow for the surge duration time.

## 4 Creating a Method

Creating a GC-MS Method in Xcalibur Software

9. If you have a Programmable Temperature Vaporizer (PTV), click the **PTV-Front** or **PTV-Back** tab to configure it. See [Figure 103](#). The PTV is a low thermal mass injector that allows the instrument to rapidly heat or cool the inlet. You can use the PTV page to program the temperature of the injector. Refer to the GC documentation for details about the PTV or other types of injectors.

**Figure 103.** PTV Settings



The screenshot displays the Xcalibur software interface for configuring a PTV. The main window is titled "Pesticide Analyzer Method For TSQ 8000 (TriPlus RSH)Evo.meth - Thermo Xcalibur Instrument Setup". The "PTV (back)" tab is selected, showing the following settings:

- PTV mode:** Splitless
- Carrier mode:** Constant Flow
- Inlet:** Temperature: 75 °C, Split flow: 50.0 mL/min, Split ratio: 6.7, Splitless time: 1.00 min
- Carrier flow:** Flow: 1.200 mL/min
- Surge:** Surge pressure: 5.00 kPa, Surge duration: 0.00 min
- Septum purge:** Purge flow: 5.0 mL/min, Constant septum purge: checked, Stop purge for: 0.00 min
- Carrier options:** Vacuum compensation: checked, Carrier gas saver: unchecked, Gas saver flow: 20.0 mL/min, Gas saver time: 2.00 min

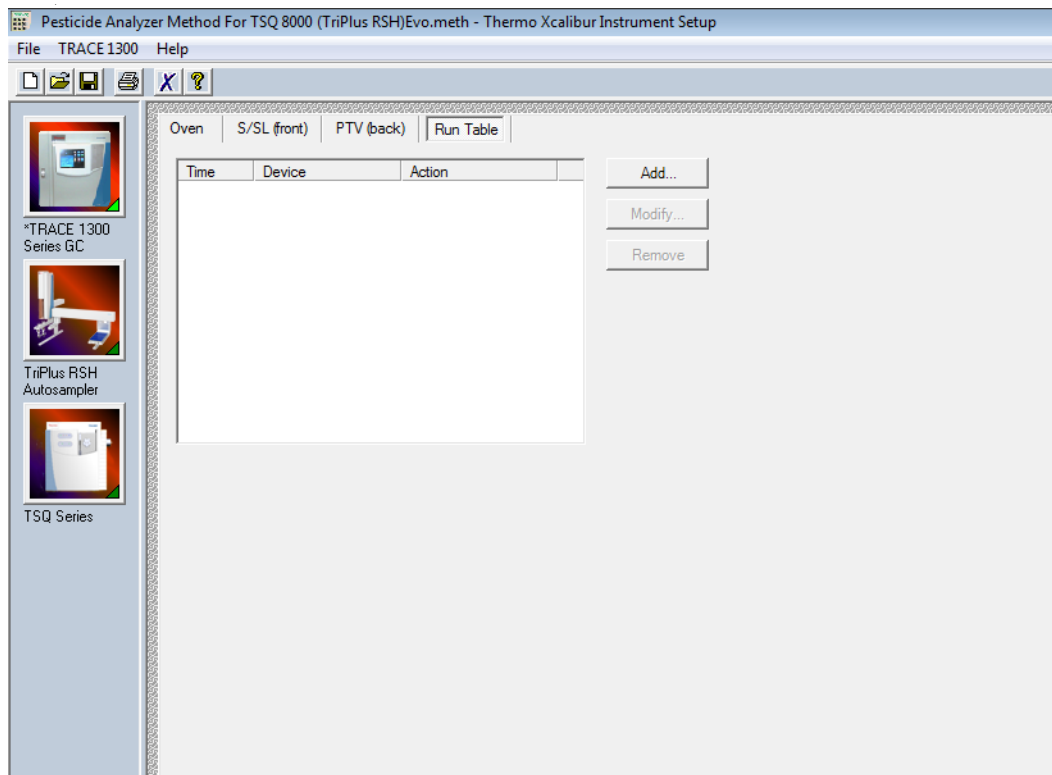
The **Injection phases** table is also visible:

	Press. kPa	Rate °C/sec	Temp. °C	Time min	Flow mL/min	Back flush
Injection	70.00			0.10	50.0	<input type="checkbox"/>
Transfer	210.00	2.5	300	3.00		
Cleaning		14.5	330	20.00	75.0	<input type="checkbox"/>

Additional settings include: Evaporation phase: unchecked, Transfer temp. delay: 1.00 min, Cleaning phase: checked, Post-cycle temperature: Cool Down, Ramped pressure: unchecked. A "Show Chart..." button is located at the bottom of the injection phases section.

10. Click the **Run Table** tab to configure how to control external valves and devices. Refer to the GC documentation for more detailed information.

**Figure 104.** Configuring the GC Run Table



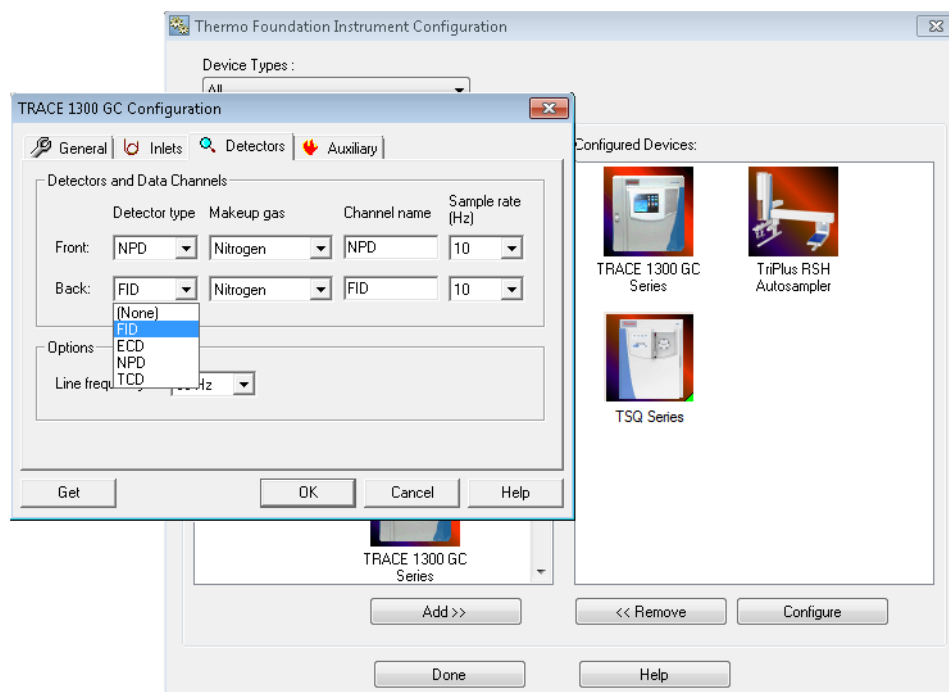
**Note** The user interface reflects the current configuration of your GC. If you add, remove, or change inlets or detectors, redo your instrument method according to the new GC configuration.

11. To add an inlet or detector to the Method Editor user interface:
  - a. Attach the inlet or detector to the GC. Refer to the GC documentation for instructions.
  - b. Add the inlet or detector to the current instrument configuration. Choose **Start | All Programs | Thermo Foundation 3.1 | Instrument Configuration**.
  - c. In the **Configured Devices** pane, click the **TRACE 1600** or **TRACE 1610** icon. Click **Configure**.

## 4 Creating a Method

Creating a GC-MS Method in Chromeleon Software

**Figure 105.** Adding a GC Inlet or Detector to the Method Editor



- d. In the TRACE 1600 Series GC Configuration dialog box, select the **Inlets** or **Detectors** tab as appropriate.
- e. Click **Get**. The software automatically detects the attached modules. Select the gases as appropriate for your setup. The default Channel names are Channel 1 and Channel 2. You may want to change them to something more descriptive. Your hardware is now configured.

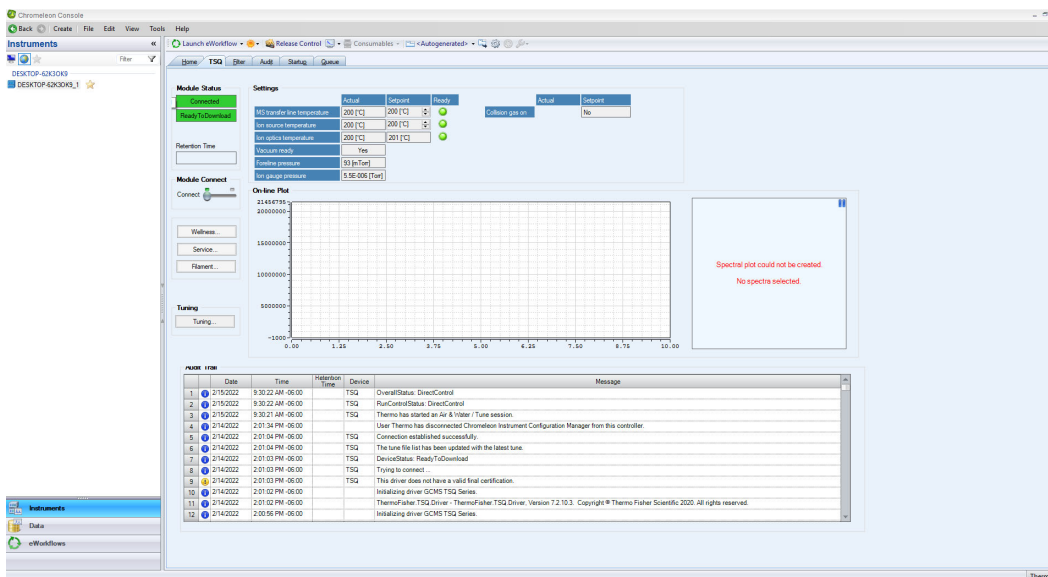
## Creating a GC-MS Method in Chromeleon Software

If your system is running Chromeleon software, follow the instructions in this section to create a method for the autosampler, GC, and TSQ 9610 mass spectrometer.

### ❖ To create a GC-MS method in Chromeleon Software

1. Open the Chromeleon Console. Select **TSQ 9610** from the left menu. The TSQ window opens. See [Figure 68](#).

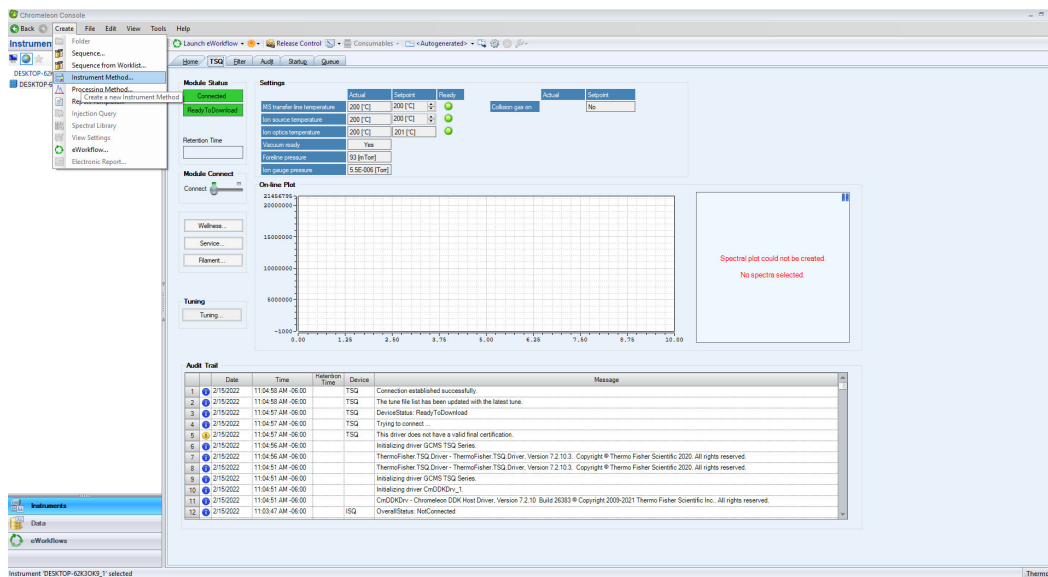
Figure 106. TSQ Window



**Note** Instructions for setting the most common parameters for the TriPlus RSH Sampling System follow. Refer to your autosampler documentation for more detailed information about settings.

2. Go to **Create > Instrument Method.**

Figure 107. Creating an Instrument Method

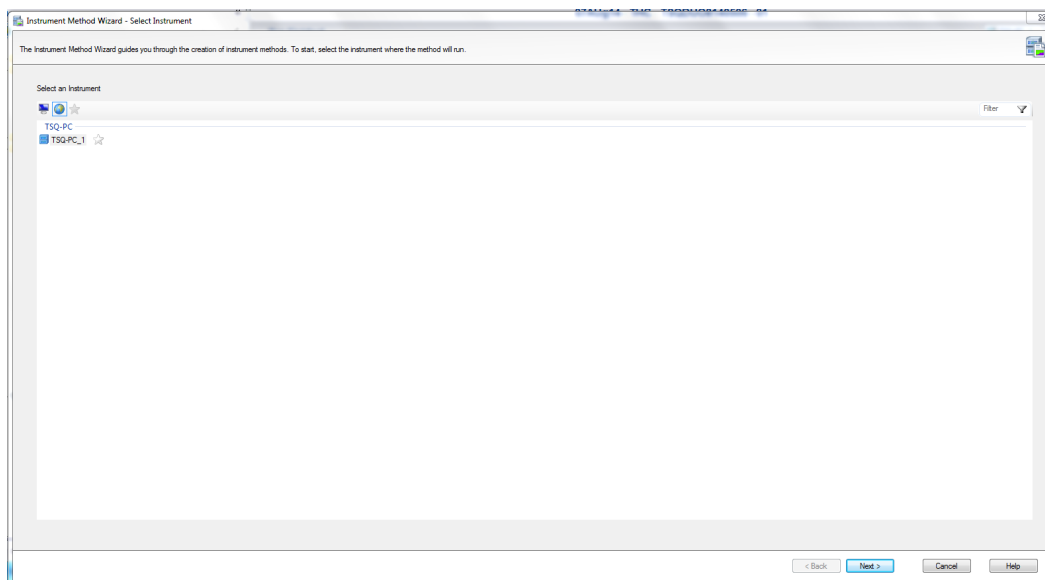


3. The Instrument Method Wizard – Select Instrument window opens. See Figure 108.

## 4 Creating a Method

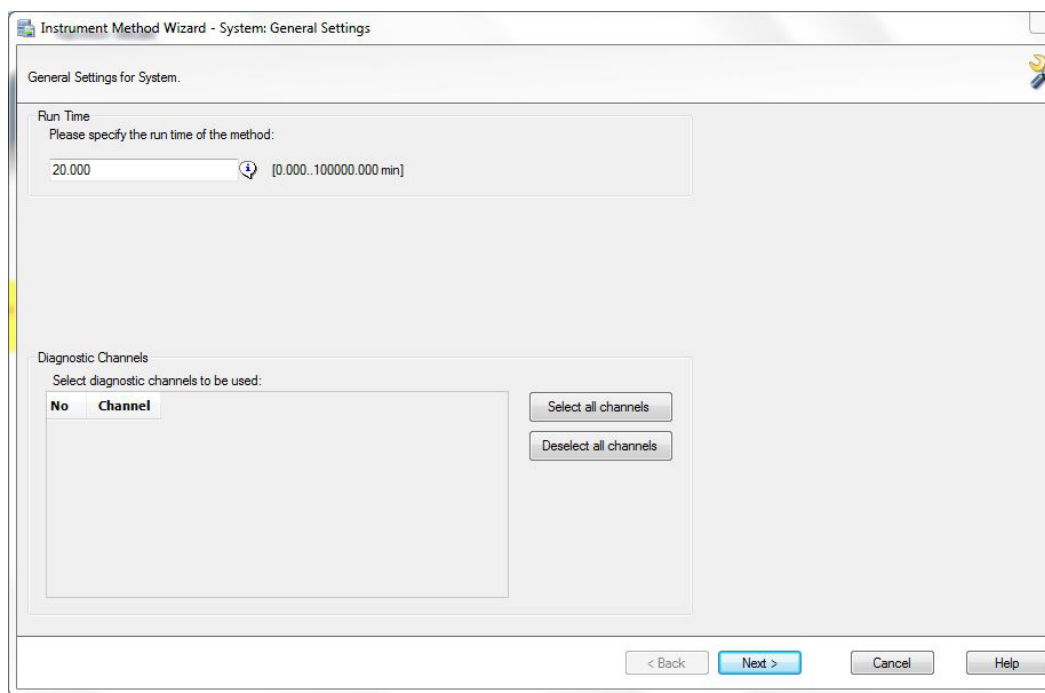
Creating a GC-MS Method in Chromeleon Software

**Figure 108.** Instrument Method Wizard – Select Instrument



4. Select the instrument you want to configure and click **Next**.
5. The **Instrument Method Wizard – System: General Settings** window opens. See [Figure 109](#).

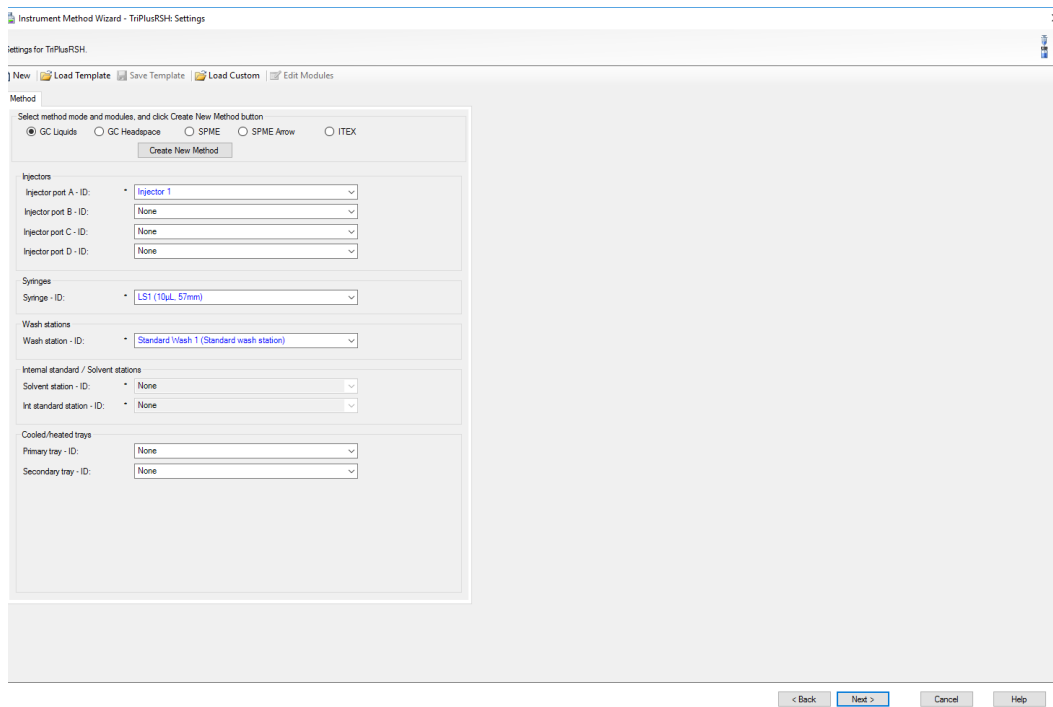
**Figure 109.** Instrument Method Wizard – System: General Settings



6. You can set the GC Run Time for the method here, or load it with the other GC settings later. Click **Next**.

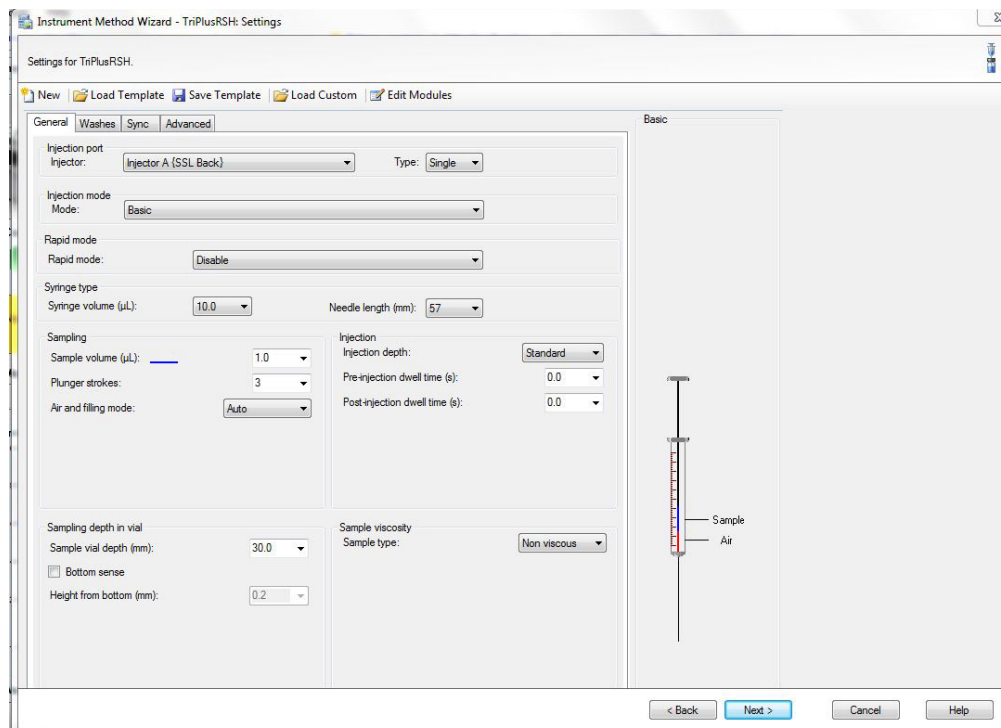
7. The **Instrument Method Wizard – TriPlusRSH: Settings** window opens. See [Figure 70](#).

**Figure 110.** Instrument Method Wizard – TriPlus RSH: Settings



8. Choose one of these three options: **GC Liquids**, **GC Headspace**, **SPME**, **SPME Arrow**, or **ITEX**.
9. Enter the ID information for your samples. You must fill in any field with an asterisk (\*)
  - a. Injectors—Enter the injection ID into the corresponding injector port.
  - b. Syringes—Enter the syringe ID information.
  - c. Wash Station—Enter the wash station ID information.
  - d. (Optional) Internal Standard/Solvent Stations—Enter ID information for your solvent station or interval standard station.
  - e. (Optional) Cooled/Heated Trays—Enter ID information for your primary and, if used, secondary trays.
10. Click **Create New Method**.
11. Use the following instructions to configure the GC Liquids general method settings. See [Figure 71](#).

Figure 111. General GC Liquids Settings on the TriPlus RSH Sampling System

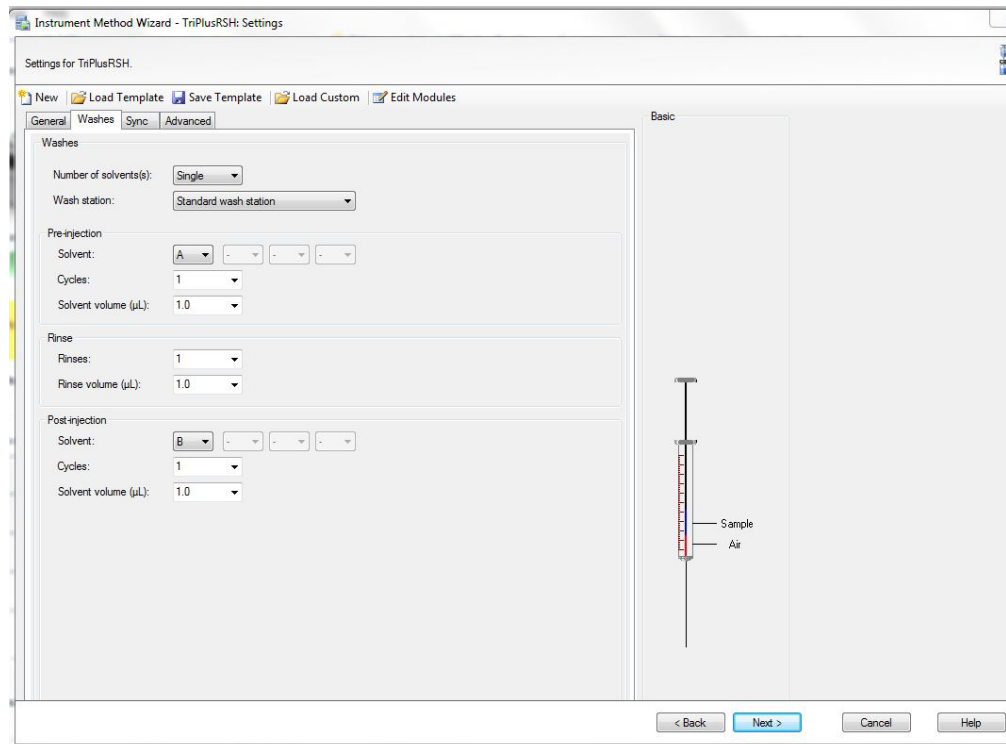


- a. Injector Type—Choose Single or Double for each injector.
- b. Injection Mode—Choose Basic, Enrichment, Enrichment Needle Solvent Option, Internal Standard Double, Internal Standard Post, Needle Solvent Wash, Solvent Flush Double, or Solvent Flush Post.
- c. Rapid Mode—Choose Disable, After Sample Rinse, After Bubble Elimination, or After Sample Asp. in Home.
- d. Syringe Type—Enter your syringe volume in  $\mu\text{L}$ . Enter the syringe needle length in mm.
- e. Sample Volume—Enter the sample volume to be injected into the GC. Typical values are between 0.5 and 5  $\mu\text{L}$ .
- f. Plunger Strokes—Select the number of plunger strokes to use when drawing up the sample. Air bubbles in the syringe change the amount of sample injected, which can cause signal variation in different runs. To prevent this from occurring, increase the number of plunger strokes to reduce the chance of an air pocket in your syringe. Typical values are between 3 and 10.
- g. Air and filling mode—Choose Auto to use the default or Custom to change the parameters.
- h. Sample Viscosity—Select Viscous if your sample is viscous or Non Viscous if your sample is non-viscous. With a viscous sample, the syringe is filled more slowly than if it was non-viscous. Since the amount of time saved is so small, setting this option to Yes might be easier.



- i. Sampling Depth in Vial—Select the Bottom Sense check box and enter the height from the bottom of the vial (in mm) at which the tip of the syringe needle will be placed in the sample vial when it is being filled.
  - j. Injection Depth—Select Standard or Minimum to indicate how the sample is introduced into the GC. If you select Standard, the autosampler inserts the needle all the way into the injection port. If you select Minimum, the autosampler barely enters the injection port.
  - k. Pre-inj Dwell Time(s)—Use this field to enter the time (in seconds) that the needle will be in the injection port before the plunger injects the sample.
  - l. Post-inj Dwell Time(s)—Use this field to enter the time (in seconds) that the needle will be in the injection port after the plunger injects the sample.
12. Configure the settings under the **Washes** tab (see [Figure 72](#)):

**Figure 112.** GC Liquids Washes Settings



- a. Number of Solvents—Choose Single or Multiple depending on the number of solvents you will use for your method. You may choose up to four solvents: A, B, C, or D.
- b. Wash Station—Choose Standard Wash Station or Large Wash Station. Refer to the autosampler documentation for more information about the wash stations.
- c. Pre-injection—Use the Solvent and Cycles fields to set the number of solvent purges that will occur before the autosampler touches your sample. Always include some sample rinses, either before or after injection, to make sure you do not have sample carryover from one injection to the next. Configure the settings so that the syringe is

## 4 Creating a Method

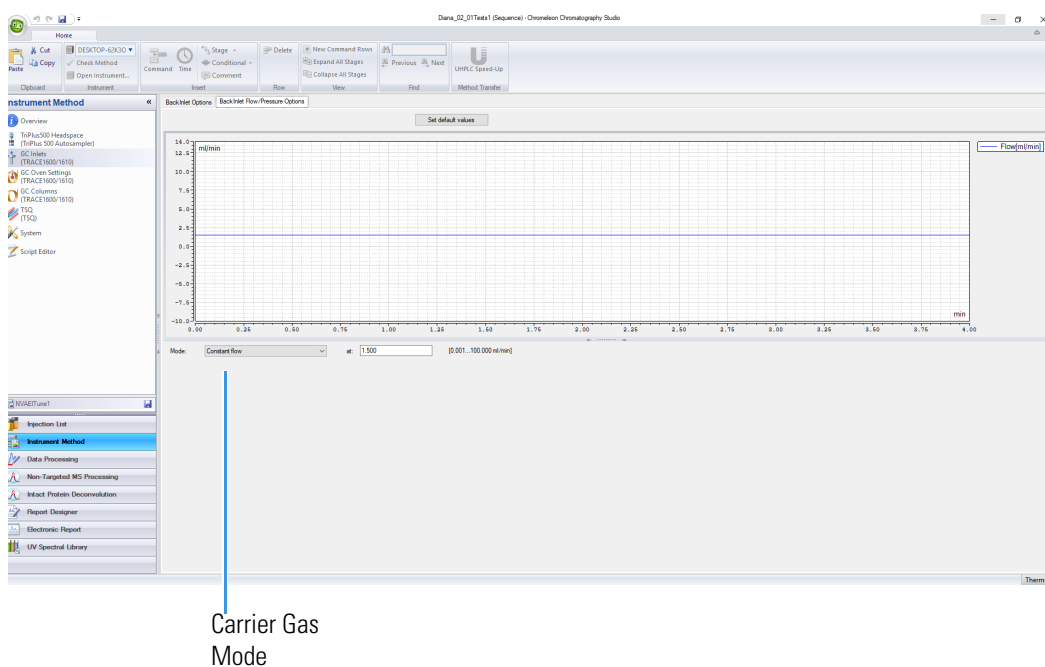
### Creating a GC-MS Method in Chromeleon Software

purged with the same solvent that was used in location A, B, C, or D or with solvents A and B or C and D. Typically, there is 0 or 1 cycles of pre-injection purges.

- d. Rinse—Use the Rinses list to select the number of times the syringe is rinsed with your sample before each injection. Rinses help ensure the sample being injected is not diluted by the residual rinse solvents. By purging the syringe with your sample before injection, the dilution is minimal. The standard setting is between 1 and 3 rinses. If you have a very limited amount of sample, however, you may want to set this field to 0 to conserve the sample.
- e. Post-injection—Use the Solvent and Cycles fields to set the number of solvent purges that will occur after the autosampler touches your sample. You should always have some sample rinses, either before or after injection, to make sure you do not have sample carryover from one injection to the next. You can have the syringe purged with the same solvent that was used in location A, B, C, or D or with solvents A and B or C and D. Typically, there are 1 to 5 cycles of post-injection purges.

13. Click **Next**. The **Instrument Method Wizard – GC Inlets(TRACE1600Series): FrontInlet** (or **BackInlet**) **Flow/Pressure Options** window opens.

**Figure 113.** Instrument Method Wizard – Front Inlet Flow/Pressure Options

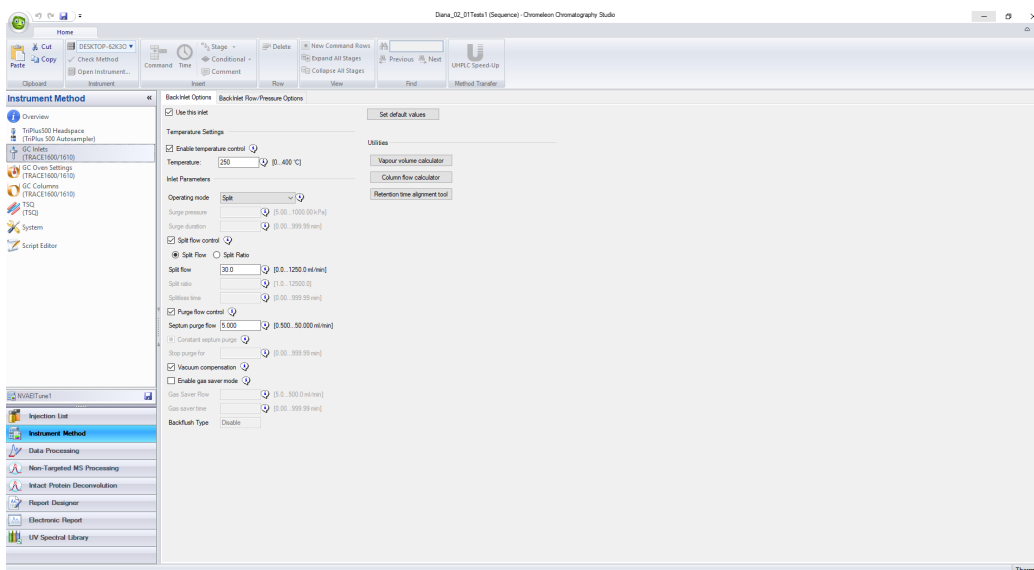


14. Set the **Mode** to **Constant Flow**, **Constant Pressure**, **Programmed Flow**, or **Programmed Pressure**. The gas flow and the oven temperature work together to determine how well the analytes are separated and how long the analysis will take. If you use constant pressure, as the column is heated in the oven, the flow rate will fall as the viscosity of the carrier gas increases. If you use constant flow, the carrier gas pressure will increase as the column temperature increases to keep the flow constant. Constant flow is more common. Typical flow rates are 1-3 mL/min. The pressure depends on the column

length and internal dimensions, so there is not a typical value. Because the outlet of the column is in the TSQ 9610 instrument, which is under vacuum, be sure the vacuum compensation is on to ensure accurate flow rates.

15. Click **Next**. The **Instrument Method Wizard – GC Inlets(TRACE1600Series): FrontInlet Options** window opens. See [Figure 114](#).

**Figure 114.** Instrument Method Wizard – GC Inlets(TRACE1600Series): Front Inlet Options



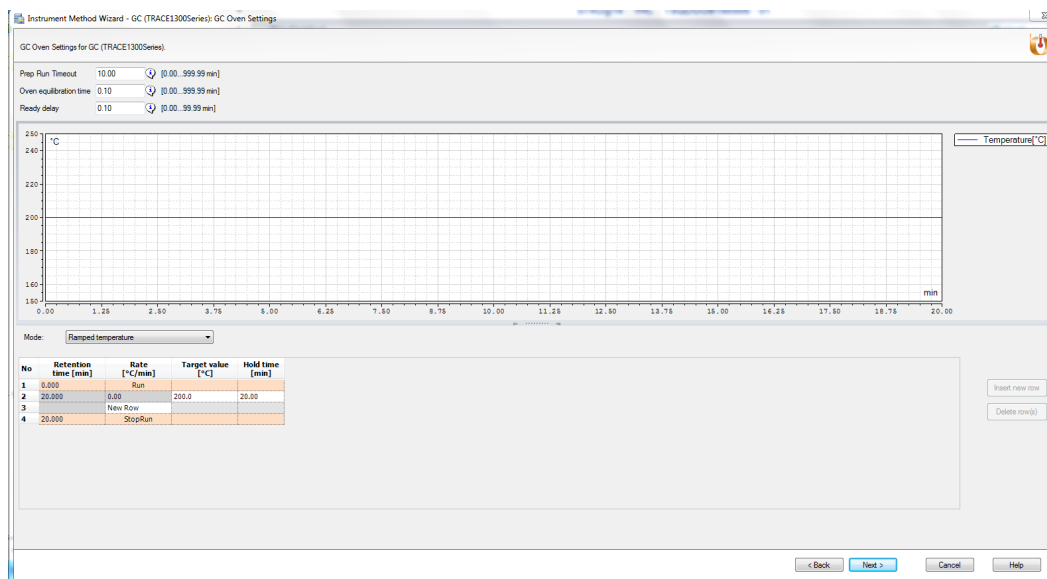
16. If you have a split/splitless inlet (SSL) injector, click the **S/SL-Front** or **S/SL-Back** tab to configure the injector port settings. In the inlet area, do the following:
  - a. Select the **Enable Temperature Control** check box and set the temperature high enough to volatilize all the analytes in your sample. The material should be injected into the port to vaporize and move into the GC column quickly. Higher temperatures can lead to thermal decomposition of some analytes, so you must optimize the injector temperature for your analysis. The SSL temperature can be set up to 400 °C (752 °F). A typical value would be 250 °C (482 °F).
  - b. Select the **Split Flow Control** check box to dilute high concentrations of sample. The split flow is the amount of gas that is swept through the injector to the exhaust port. Higher values will give more dilution. The split flow reduces the amount of contamination that builds up in your system. The split flow ratio is the ratio of the split flow to the carrier gas flow. It is effectively the dilution ratio of the sample. This setting is typically turned on and set to a flow of 50 mL/min. However, more carrier gas is used, so for your analysis, lower split flows may be more acceptable. If you set the split ratio, the software calculates the correct split flow. The reverse is true also.
  - c. For best results, check the **Constant Septum Purge** box to use the septum purge, which means additional carrier gas will go through the injector. The default purge flow value is 5 mL/min. This reduces the buildup of contaminants in the injector, on the column, and in the TSQ 9610 instrument. If you perform a splitless injection, even if the split flow is set, the split flow turns off for the splitless time. The septum

## 4 Creating a Method

### Creating a GC-MS Method in Chromeleon Software

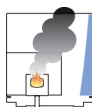
- purge turns off for the stop purge time. After these times, the split flow and septum purge are reactivated.
- If your analysis requires a higher flow to quickly sweep the analytes into the column, which may be needed with high temperature injectors and thermally labile compounds, use the surge pressure to increase the column flow for the surge duration time.
  - Because the outlet of the column is in the TSQ 9610 instrument, which is under vacuum, be sure the vacuum compensation by checking the **Vacuum Compensation** checkbox is on to ensure accurate flow rates.
  - In an effort to reduce the amount of carrier gas used, select the **Enable Gas Saver Mode**. When used, the split flow is reduced to the gas saver flow after the gas saver time. It is not recommended to use a flow of less than 20 mL/min because contaminants can build up in the injector, column, and TSQ 9610 instrument, which can affect the system performance.
17. Click **Next**. The **Instrument Method Wizard – GC Inlets(TRACE1600Series): GC Oven Settings** window opens. See [Figure 115](#).

**Figure 115.** Instrument Method Wizard – GC Inlets: GC Oven Settings

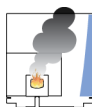


18. Set the oven temperatures in this window. There is always at least one temperature and time in any GC temperature program. In the Initial row, enter the initial temperature, which must be 4 °C (7 °F) above room temperature and less than the maximum operating temperature of your GC column. If you set the initial temperature to a value below this limit, the GC will not reach the initial temperature. If you set the temperature above the limit, the GC column will be damaged. You can set the initial hold time to a value between 0 and 999.99 minutes. The typical initial temperature is at least 10 °C (18 °F) above the boiling point of your sample solvent, and the initial time is usually long enough for the solvent to move through the column.

19. Select a maximum of 32 temperature ramps, each with its own ramp rate, final temperature, and hold time. Each temperature ramp begins at the previous ramp's temperature after the hold time has expired. A typical program has one or two ramps. The GC temperature profile is the primary method for separating your analytes from each other, the solvent, and the matrix. Your temperature profile must be optimized for your analysis needs.
20. Select the prep-run timeout. The prep-run timeout is the maximum amount of time that the GC will wait before it gives up on an injection. As an example, with the default value of 10 minutes, if the GC is ready to receive an injection, but does not receive it after ten minutes, the GC will stop waiting. This usually occurs in case of an error.
21. Set the oven equilibration time. The equilibration time is a delay between when the GC is at temperature and when the GC reports as being ready. The equilibration time is typically set to 0.5 minutes.



**CAUTION INSTRUMENT DAMAGE.** Be sure not to overheat the GC column or it may contaminate the instrument.



**ATTENTION DOMMAGES À L'INSTRUMENT.** Assurez-vous de ne pas surchauffer la colonne CG ou elle pourrait contaminer l'instrument.

22. (Optional) Enable the cryogenic option to cool the oven. If this option is selected, then the minimum allowed temperature in a temperature ramp will fall from 0 to -99 °C (32 to -146 °F). The GC also allows the use of a post-run column cleaning. This is not typically used because the material that is purged from the column in this step would go into the TSQ 9610, which can lead to contamination. If you want to use this feature, set the GC oven temperature, as well as the amount of time to remain at that temperature after the analytical run is complete. You can also set the amount of pressure used to push the carrier gas through the column. Refer to the *TRACE 1600/1610 Series GC User Guide* for more information.
23. If you have a Programmable Temperature Vaporizer (PTV), click the **PTV-Front** or **PTV-Back** tab to configure it. The PTV is a low thermal mass injector that allows the instrument to rapidly heat or cool the inlet. You can use the PTV page to program the temperature of the injector. Refer to the GC documentation for details about the PTV or other types of injectors.

**Note** The user interface reflects the current configuration of your GC. If you add, remove, or change inlets or detectors, redo your instrument method according to the new GC configuration.

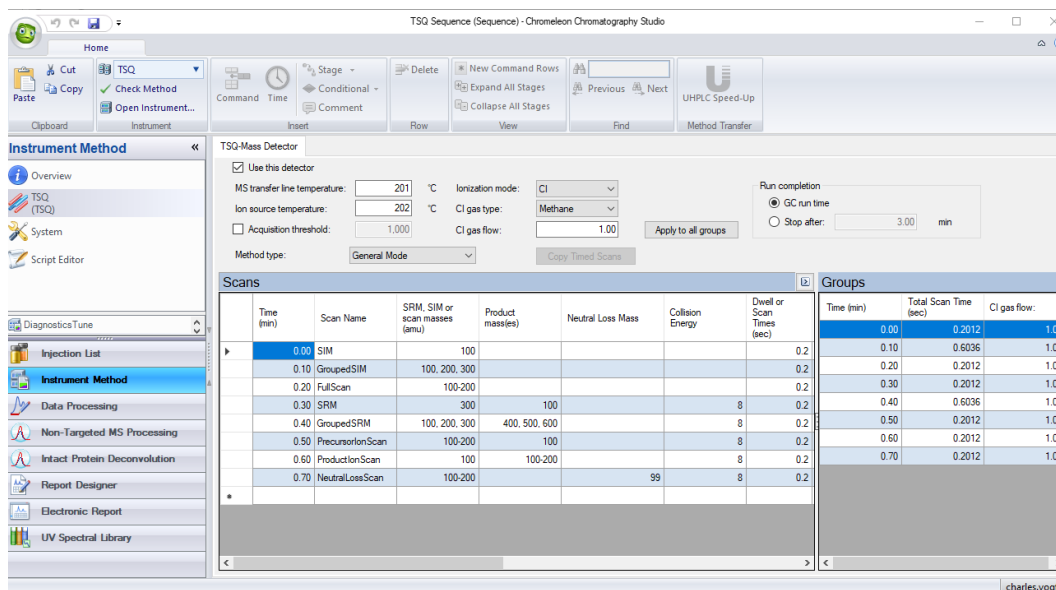
24. To add an inlet or detector to the Method editor user interface:

## 4 Creating a Method

Creating a GC-MS Method in Chromeleon Software

- a. Attach the inlet or detector to the GC. Refer to the GC documentation for instructions.
  - b. Add the inlet or detector to the current instrument configuration. See [Chapter 1, “Introduction.”](#) for instructions to configure the GC.
25. Click **Next**.
26. From the Method Type list, select **General Mode**, **Timed Mode**, or **Tune Mode**. See [Figure 73](#). An Acquisition method is used to collect data.

**Figure 116.** TSQ Series Method Type Setup



The screenshot displays the 'TSQ-Mass Detector' configuration window. The 'Method type' is set to 'General Mode'. The 'Scans' table is as follows:

Time (min)	Scan Name	SRM, SIM or scan masses (amu)	Product mass(es)	Neutral Loss Mass	Collision Energy	Dwell or Scan Times (sec)
0.00	SIM	100				0.2
0.10	GroupedSIM	100, 200, 300				0.2
0.20	FullScan	100-200				0.2
0.30	SRM	300	100		8	0.2
0.40	GroupedSRM	100, 200, 300	400, 500, 600		8	0.2
0.50	PrecursorIonScan	100-200	100		8	0.2
0.60	ProductionScan	100	100-200		8	0.2
0.70	NeutralLossScan	100-200		99	8	0.2

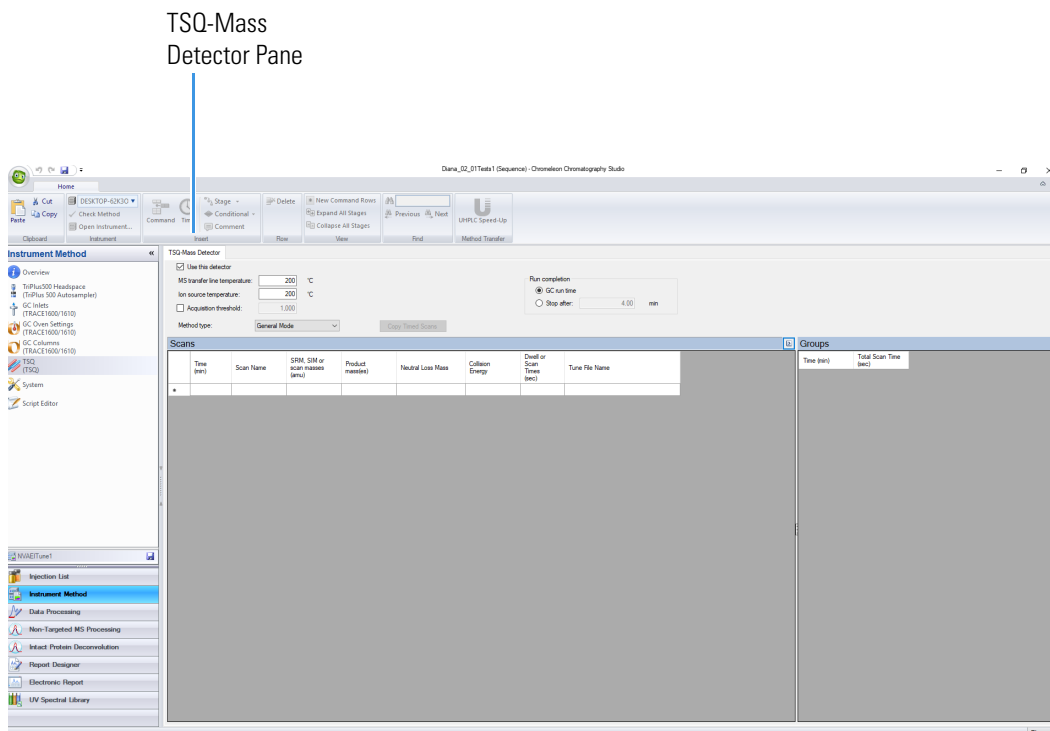
The 'Groups' table is as follows:

Time (min)	Total Scan Time (sec)	CI gas flow:
0.00	0.2012	1.00
0.10	0.6036	1.00
0.20	0.2012	1.00
0.30	0.2012	1.00
0.40	0.6036	1.00
0.50	0.2012	1.00
0.60	0.2012	1.00
0.70	0.2012	1.00

**Note** The **Maintenance** method is used to bake out or cool down the instrument during a sequence. This can be useful if you know you want to perform these tasks and you want to do them in an automated way as part of your sequence.

27. Use the **Method Setup** pane to set the temperatures and acquisition threshold in General Acquisition mode. See [Figure 74](#) on [page 78](#).

**Figure 117.** General Mode: Setting Temperatures and Acquisition Threshold



- a. Set the **MS Transfer Line Temperature**. This field represents the temperature of the transfer line, which is the tube that contains the column as it leaves the GC oven and enters the TSQ 9610 system. The maximum allowable temperature is 400 °C.

**Note** The maximum transferline temperature of or the rate at which higher transfer line set temperatures may be reached can depend upon the ion source temperature and the GC oven temperature.



**CAUTION** You will damage the column and contaminate the TSQ 9610 instrument if you set the transfer line temperature above the maximum allowed temperature for the column. For most polyimide-coated columns, damage begins to occur when the column is held at a constant temperature above 280 °C.



**ATTENTION** Si vous configurez la température de la ligne de transfert au-dessus de la température maximum autorisée pour la colonne, vous endommagerez la colonne et contaminerez l'instrument TSQ 9610. Pour la plupart des colonnes à revêtement polyimide, les dommages commencent à se produire lorsque la colonne est maintenue à une température constante au-dessus de 280 °C.

- b. Set the **Ion Source Temperature**. You can enter a value between 0 and 350 °C. The optimal temperature depends on the analyte. Higher temperatures will keep the ion source cleaner, but will lead to increased fragmentation, which may reduce sensitivity.

- c. (Optional) Select the **Acquisition Threshold** check box and enter a value for the minimum peak height for the data file, if needed. If your peak has an intensity that is below this threshold, it will not be stored. This setting may help reduce noise, but it may also alter the reported isotope ratios because the smaller isotope signals will be preferentially reduced.
- d. Select **EI** from the **Ionization Mode** pull-down menu.

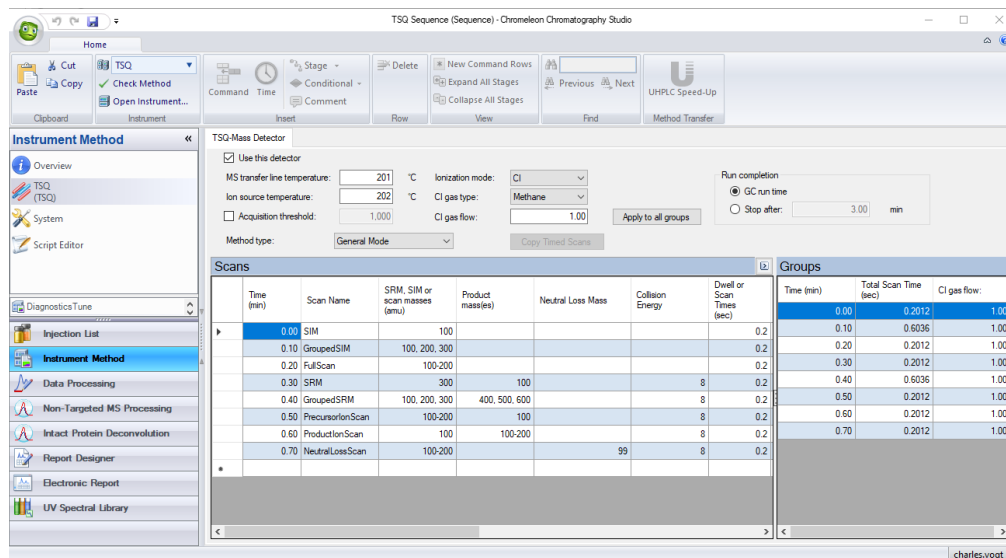
**Note** Although CI settings are present in the TSQ Series software, chemical ionization is not available on the TSQ 9610, and the CI settings are inactive.

**Note** The following parameters apply only to the **General Mode** method type only. **General Mode** is the recommend setting for full-scan only MS methods, or simple SIM or SRM methods. If you need to develop a complex SIM or SRM method with a large compound list or overlapping retention times, refer to the instructions for **Timed Mode**.

28. For General Mode methods only, do the following:
  - a. In the **Run Completion** group, select the condition under which the run will end.
    - **GC Run Time**—Select this option if you want the MS run to end when the GC run is complete.
    - **Probe Run Time**—Select this option if you have a probe controller installed and you want the MS run to end when the probe run is complete.
    - **Stop After**—Select this option to set the number of minutes you want the MS to run. The end of the run can be between 0 and 1000 minutes. With this option you can stop the acquisition when all the compounds of interest have eluted, but the GC is still at an elevated temperature to keep the column clean. Thermo Fisher Scientific recommends that you select this option to save burn time on the filament.
  - b. In the Scans pane, click a scan row to enter scan information under each column. See [Figure 77](#).



**Figure 118.** Setting General Model Scan Information



**Note** If some of the following columns are not shown in the Scan pane, you can right-click and display them. You can also reorganize the columns by clicking the heading of a column and dragging it to the left or right.

- i. Use the **Time (min)** column to set the time that the MS begins to acquire the scan group. Set the time for the first group late enough to allow the solvent to move through the system, and early enough to ensure the first analyte will be captured in the segment. Set subsequent segment times so that the start time will occur between compounds of interest. You may set up different types of scans in a single group. The scans will occur in descending order.

Your method may allow sequential full scans and SIM scans of a compound. As an example, in this method, the mass range of 50–300 will be scanned in 0.2 seconds. Immediately after the full scan finishes, the SIM scans begin. The SIM scans occur sequentially. Two different SIM masses, at 43 and 44, will be looked at for 0.05 and 0.08 seconds, sequentially. These simultaneous full scan and SIM scans will begin 2.5 minutes into the GC run. You will get a complete set of scans every 0.337 seconds. At 5 minutes into the GC run, the scans change to a set of SRM scans. The first SRM transition is 292.9 to 257.91 with a collision energy of 20 eV. The second SRM transition is 262.91 to 192.93 with a collision energy of 32 eV. Both SRM scans have a dwell time of 0.05 seconds. You will get a complete set of scans every 0.105 seconds.

**Note** The faster the MS scans, the more data points across a peak it will acquire. However, the precision of individual scans may be reduced.

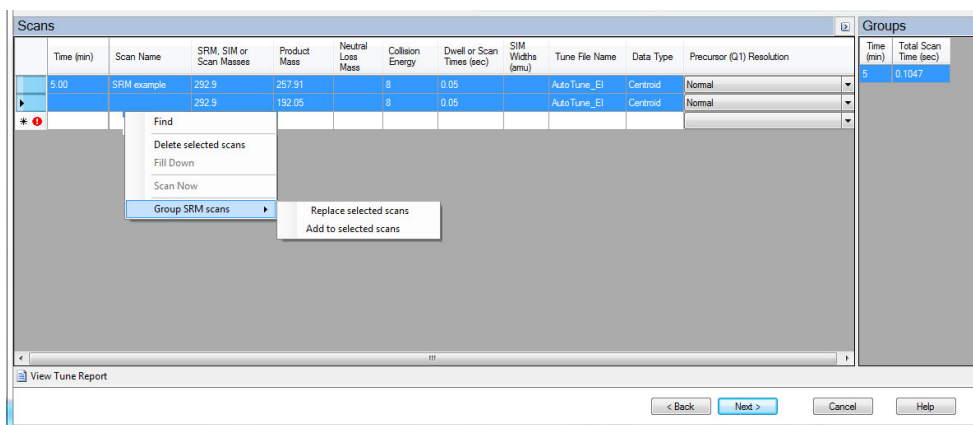
All of these scans use the most recent AutoTune\_EI file. You can also use a specific tune file for each of the scans.

- ii. Use the **SRM, SIM, or Scan Masses** column to tell the MS which masses to scan.
  - In full-scan mode, enter the start and end mass separated by a dash. You must put each full-scan range on a separate line.
  - For SRM methods, enter precursor masses, product masses, and collision energies of the ions you wish to monitor. Separate scan filters will be created for each SRM transition during acquisition.

**Note** Each line in a scan must only contain a full-scan range, individual SIM masses, or an SRM transition. Scan types cannot be mixed in a single line. Set up simultaneous scans by giving them the same time in the **Time (min)** column.

- If you would like to combine multiple SRM transitions in a single scan filter, highlight the rows you want to combine and then right-click and select **Group SRM Scans | Replace Selected Scans**. See [Figure 78](#). You can also use this function to ungroup a group of SRM scans into individual rows.

**Figure 119.** Grouping SRM Scans



- iii. Enter the product ion mass (for SRM methods) in the **Product Mass** column. The product ion mass is the result of fragmenting the precursor ion with collision gas. If you want to perform a precursor ion scan, enter the mass of the target precursor ion into this column.

**Note** Entering a product ion mass changes a scan to SRM.

- iv. Use the **Neutral Loss Mass** column when you want to perform a neutral loss scan. Enter the mass of the target precursor ion in this column. The scan mass range must be at least 2.5 amu wide and must begin at 1 + the precursor ion mass.
- v. In the **Collision Energy** column, enter the collision energy (for SRM methods) in eV. The collision of a precursor ion with the collision gas at a particular energy fragments the precursor ions into product ions. By varying the collision energy, a single precursor ion can be fragmented into several product ions. An SRM

transition is defined by a precursor ion being fragmented into a particular product ion mass using a certain collision energy. The Collision Energy column is unusable unless you define a precursor and product ion mass.

**Note** The system controls the collision gas so it will be ready when an MS/MS scan is requested.

- vi. In SIM or SRM mode, use the **Dwell or Scan Times** column to define the amount of time (in seconds) that the MS will look at your SIM ion mass or your SRM product ion mass. If you are in full-scan mode, the **Dwell or Scan Times** column determines the amount of time to scan across the designated range. Set this value to have 5–20 scans across your GC peak. If you have too few scans, the GC peak area is inaccurate. If you have too many scans, the MS signal becomes less precise. This column must be set to a value between 0.0005 and 5 s for SRM and SIM methods. The default is 0.2 s. For full scan methods, the minimum scan time depends on the mass range so that the scan rate does not exceed 13,000 amu/s.
- vii. Use the **Tune File Name** to select a tune file to be used for this scan. Select the AutoTune file you created in [Chapter 3, “Tuning,”](#) . If you wish to use the same tune file for multiple scans, you can fill down this column by right-clicking on a tune file name.

**Note** Selecting a tune file to open without a date-time stamp opens the most recent tune of the tune type selected. To use a specific tune file, select a tune file of that prefix with the date-time stamp that you want.

**Tip** Use a tune file without the date-time stamp to create your method.

- viii. (Optional) Use the **Scan Name** column to enter a description of the scan. You may use the name as a label to indicate the compound used with the scan.

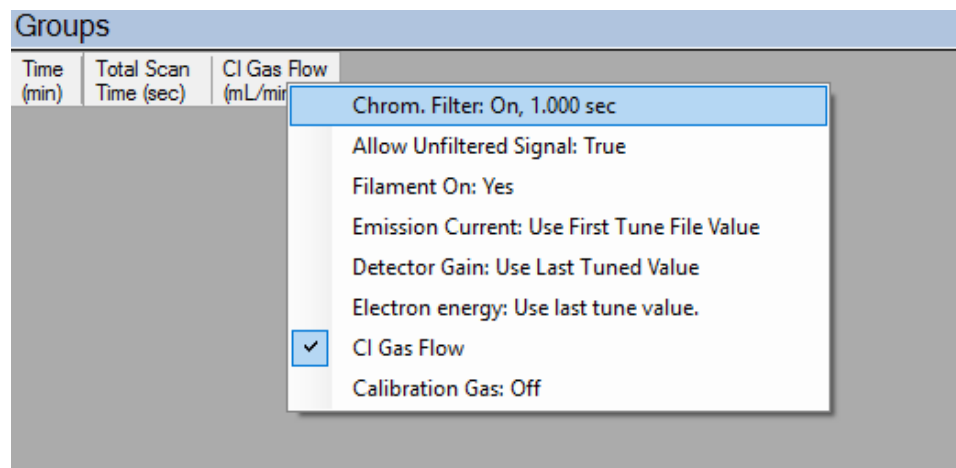
**Note** Scan Name, SIM Widths, Data Type, and Q1 Resolution columns are not shown by default. To view them, right-click one of the column headers to pull up the menu to display the hidden columns

- ix. Use the **SIM Widths** column to set the width range of the SIM window. The range of values can be between 0.01 and 10. The default is 1 amu, which means the MS will collect all the ions from your SIM mass  $\pm 0.5$  amu.
- x. Use the **Data Type** column to select whether you want to collect **Profile**, **Centroid**, or **Nominal** mass spectra. Centroided mass spectra are the most common because they are used by most of the libraries and provide the smallest data files. Profile mass spectra provide detailed mass spectral peaks, which result in large data files. Profile mass spectra are not available for SRM scans. when you want to perform fast scanning (up to 20,000 amu/s), select **Nominal** from the drop-down list under **Data Type**.

- xi. Use the **Precursor (Q1) Resolution** column to open the peak width of the precursor mass for SRM scans. The options are **Normal**, **Wide (1.5 at 50%)**, **Widest (2.5 at 50%)**, or **Custom**. The default setting is Normal, which uses the tuned resolution values from the tune file specified in the **Tune File Name** column. Selecting Wide or Widest increases the precursor peak width to 1.5 and 2.5 amu (at 50%) respectively. Opening the precursor peak width will increase the ion signal into the collision cell and may improve the sensitivity of your method; however, it may also increase the background noise level. Set Custom width in the tune types. If using the default tune types, Custom width is 1.2 FWHM.
- xii. Use the **Product (Q3) Resolution** column to open the peak width of the precursor mass for SRM scans. The options are **Normal**, **Wide (1.5 at 50%)**, **Widest (2.5 at 50%)**, or **Custom**. The default setting is Normal, which uses the tuned resolution values from the tune file specified in the **Tune File Name** column. Selecting Wide or Widest increases the precursor peak width to 1.5 and 2.5 amu (at 50%) respectively. Set Custom width in the tune types. If using the default tune types, Custom width is 1.2 FWHM.
- c. In the **Groups** pane on the right, review the information in each row. See [Figure 79](#). As you create scans in the Scans pane, information in the groups pane is automatically displayed.

**Note** By default not all columns are displayed in the Groups pane. Right-click a heading to display them. You can also reorganize the columns by clicking the heading of a column and dragging it to the left or right.

**Figure 120.** Accessing the Groups Pane



- i. The **Time (min)** column indicates the time that the MS begins to acquire data after the GC starts for that group. It is typical to have enough of a time delay for the start of the first group to allow the solvent to get through the column before starting acquisition. The Time column in the group pane cannot be modified. If necessary, modify the scan time in the Scans pane.

- ii. The **Total Scan Time (sec)** column indicates the sum of all the scans in each segment. See Figure 80. The total scan time also contains the stabilization time that occurs between each scan. This method, beginning 2.5 minutes into the GC run, gives you a complete set of scans every 0.337 seconds. At 5 minutes into the GC run, the scanning completely changes. Now the scans will repeat every 0.105 seconds until the GC run is complete. As the total scan time is a calculated value, it is not editable.

Figure 121. Determining Groups Total Scan Time

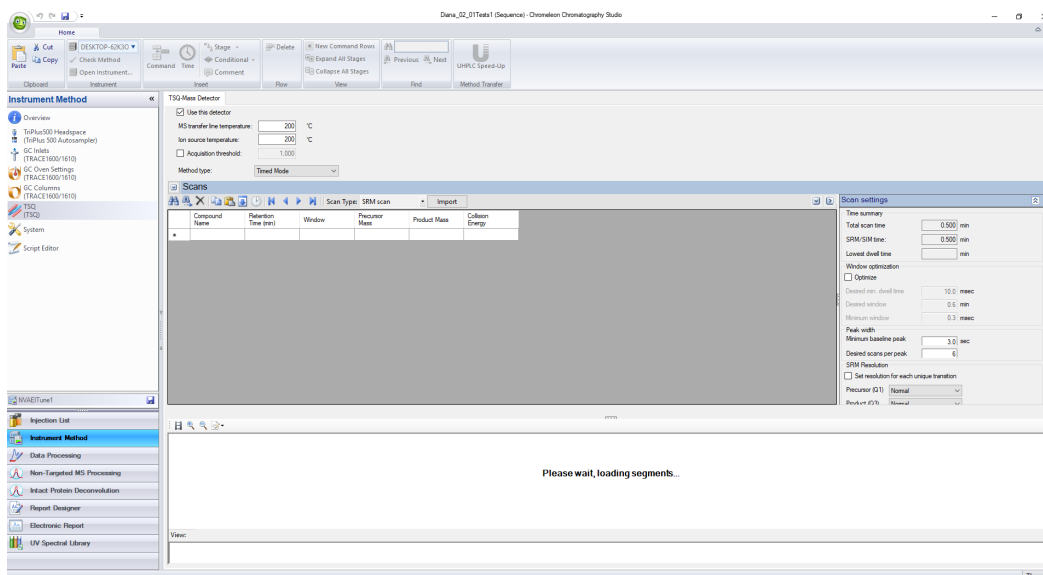
Time (min)	Scan Name	SRM, SI Scan No	Time (min)	Total Scan Time (sec)	Chrom. Filter On	Chrom. Filter Peak Width (sec)	Filament On	Use Tune File Emission Current	Emission Current (µA)	Use Last Tuned Detector Gain	MS/MS Gain Multiplier	Detector Gain	Use Tune File Electron Energy	Electron Energy (eV)	Calibration Gas
5.00	SRM example	292.9	5	0.1047	<input checked="" type="checkbox"/>	1.000	<input checked="" type="checkbox"/>	<input checked="" type="checkbox"/>	50	<input checked="" type="checkbox"/>	7	1.00E+005	<input checked="" type="checkbox"/>	0	OF
		292.9													

- iii. Use the **Chrom Filter On** column to enable the chromatographic filter. This filter smooths spectral data as it is acquired, which may increase the signal-to-noise ratio by a factor of two or more. The chromatographic filter is most useful when at least four full scans are acquired across a GC peak. This setting is typically left on.
- iv. Use the **Chrom Filter Peak Width** column to set the peak width to match the width of the GC peak (in seconds). If the peak width is set too large, signal intensity may be reduced. The default value is 1 s.
- v. Use the **Allow Unfiltered Signal** column for most methods. To improve integration of congeners, the box must be checked. Leaving the box unchecked helps improve the signal-to-noise ratio for resolved chromatographic peaks. This feature is not checked by default in General Acquisition mode.
- vi. Use the **Filament On** column to turn the filament on and off in the selected segment. Turning off the filament increases the lifetime of the filament and keeps the ion source clean longer. However, no data is collected. Use this column if you had analytes eluting before the solvent peak. You can create a segment to turn off the filament during the solvent peak to preserve the filament.
- vii. Use the **Emission Current** column to set the emission current used during the acquisition. For optimal analytical performance and stability, use the emission current at which the system was tuned. However, if you want to use a different emission current, clear the **Use Tune File Emission Current** check box and enter a value in the **Emission Current (µA)** column. A high emission current will lead to the production of more ions, but the interaction of too many ions in the source can cause a degradation in the resolution and signal. The margin of error is  $\pm 0.5 \mu\text{A}$ .

viii. Use the **Use Last Tuned Detector Gain** column to indicate that you want to use the detector gain set in Auto Tune. If you do not need to use the gain set in Auto Tune or saved to the instrument in Manual Tune, then you can set the gain manually. Higher gains give larger signals, but may shorten the lifetime of the detector when concentrated samples are detected. The **MS/MS Gain Multiplier** column only applies to groups with MS/MS events. The MS/MS gain multiplier only applies if the **Use Last Tuned Detector Gain** column is selected. The default MS/MS Gain Multiplier is 7 and is intended to give similar signal levels as a SIM scan on the precursor ion. If you enter a specific gain, the MS will use that gain for the SRM scan without the multiplier.

29. The following settings apply to **Timed Mode** methods only.

**Figure 122.** Timed Mode Method Settings

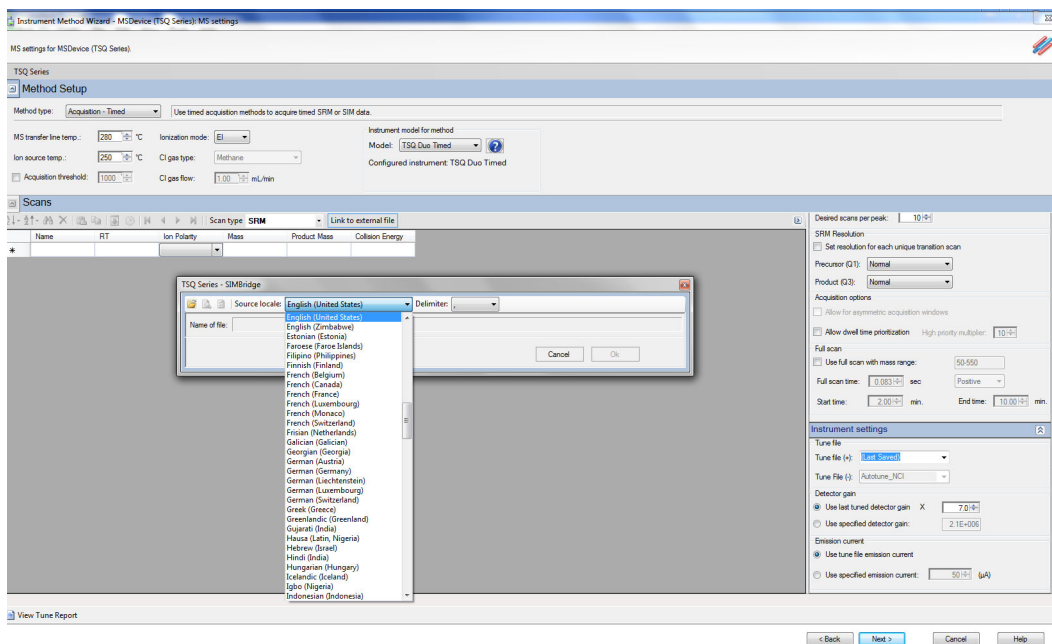


- a. In the **Scans** pane above list of scans, select **SIM Scan** or **SRM Scan** from the **Scan Type** list. If you want to link to an external method, click **Import**. You may link to a .csv or .xml method file.

**Note** In order to edit the scans within the TSQ 9610 method editor, clear the **Link to External File**.

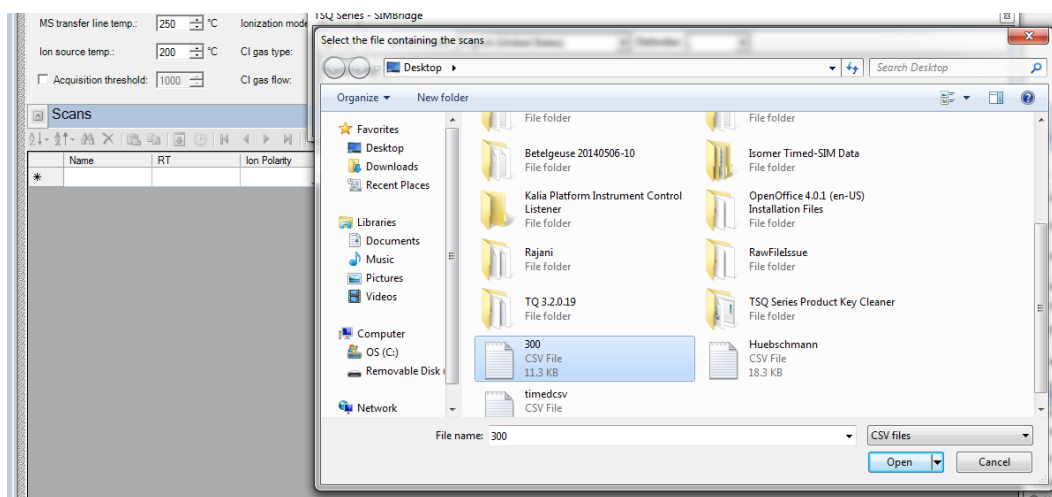
- b. After clicking **Link to External File**, the **SIMBridge** dialog box opens. Choose the language of your method file from the **Source Locale** drop-down menu. See [Figure 83](#).

Figure 123. Setting the Source Language of Method Files using SIMBridge



c. Browse to your file. See Figure 84.

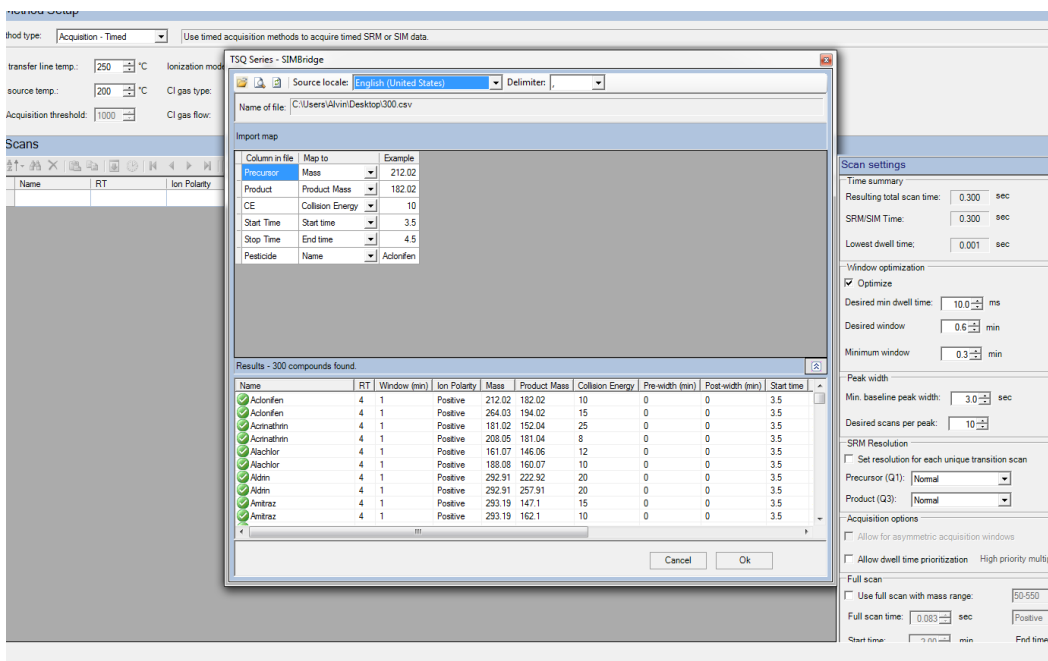
Figure 124. Linking to an External File using SIM Bridge



d. Click **Open** to open the method in SIMBridge.

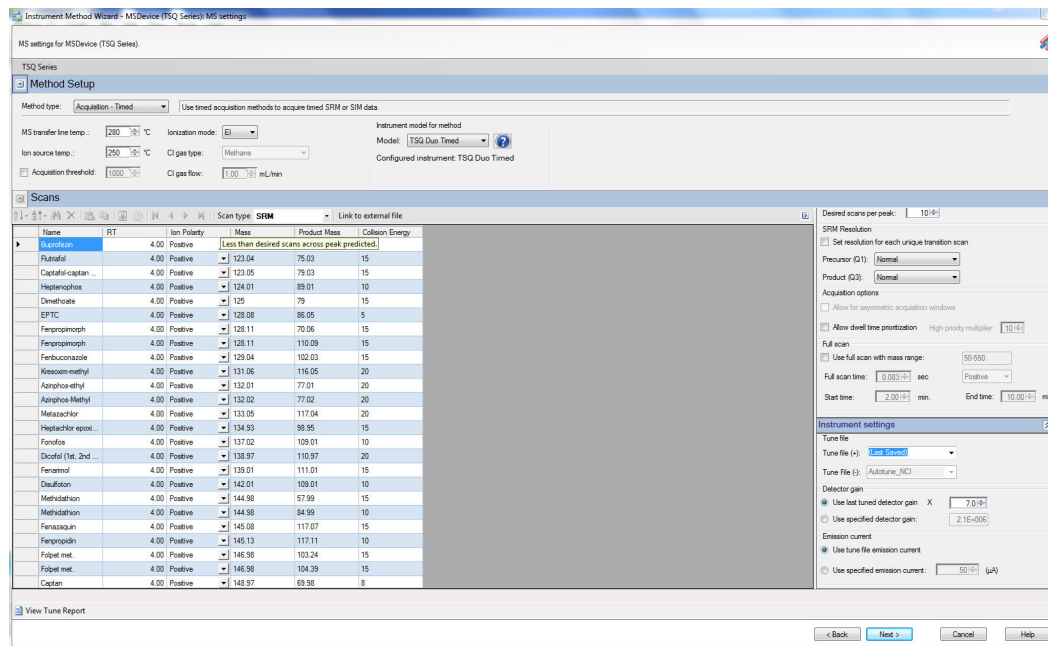
e. If necessary, change the method headings in your original file to match those in the method editor. A green check mark appears when your method is validated. See Figure 85.

Figure 125. Changing Method Headings in SIMBridge



f. Click **Open** and the external method will be opened in the method editor. See Figure 86.

Figure 126. Viewing a Linked File in the Method Editor



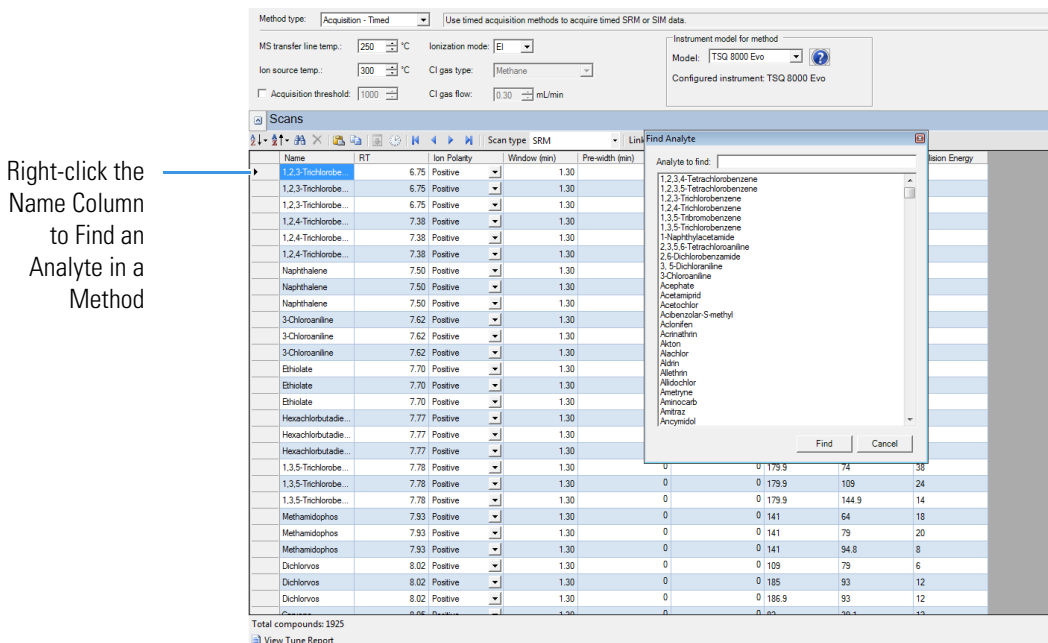
g. If you open an older model TSQ 8000, TSQ Duo, or a TSQ 8000 Evo (if you have a TSQ 9610 system) method, the **Instrument Model for Method** box appears.

h. Select your model from the drop-down menu in **Instrument Model for Method** in order to make the imported method compatible with your model.



- i. In the **Name** column, enter the analyte name. If you have linked to an external file, the analyte name located in the first column of your linked file will appear in the first cell in the Name column. Right-click this window to search for an analyte within your method. See Figure 87. This function is useful if you need to edit an analyte in a complex method.

**Figure 127.** Finding an Analyte in a Method



- j. In the **RT** column, enter retention times for SRM methods. The retention time is the time it takes an analyte to pass from the column inlet to the detector.
- k. In the **Window (min)** column, set the acquisition times. Smaller acquisition windows increase sensitivity but can cause you to miss your peak if set too small. Changing the window size only affects sensitivity if it reduces the number of compounds analyzed in a segment. If the windows do not overlap, you will not notice an improvement by reducing the acquisition window.

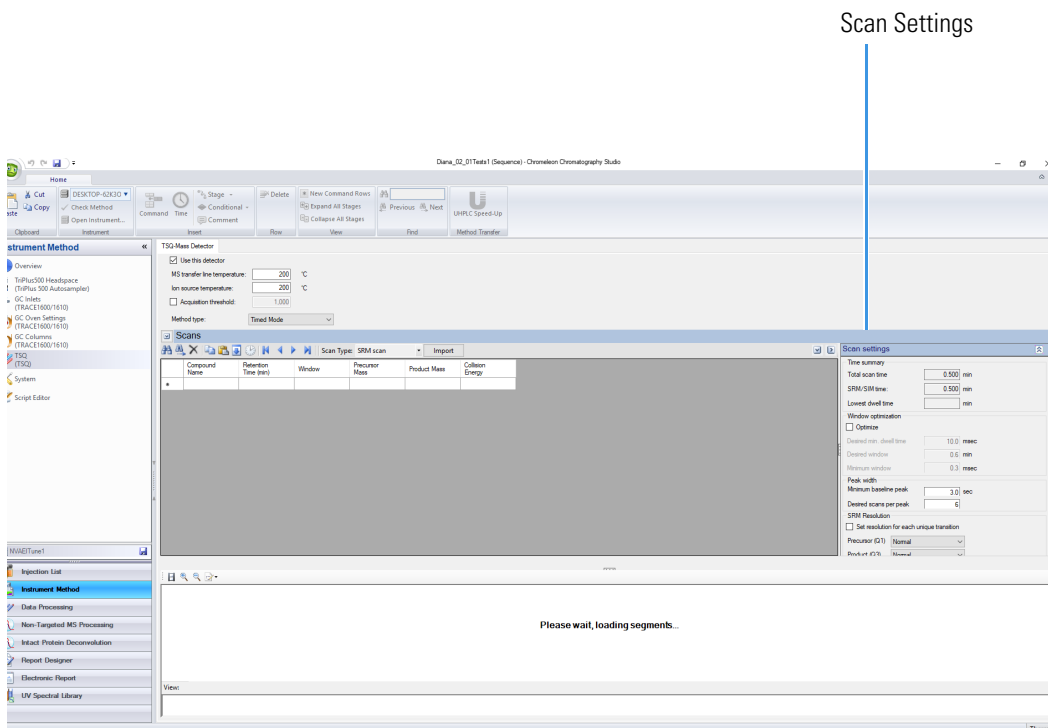
**Note** The Window (min) column does not appear by default. The Method Editor displays it only when the window optimizer is not active.

- l. In the **Mass** column, enter the precursor ion mass for SRM methods. For SIM methods, enter the mass of the ion you wish to monitor.
  - m. In the **Product Mass** column, enter the product ion mass (for SRM methods). The product ion mass is the result of fragmenting the precursor ion with collision gas.
30. In the **Collision Energy** column, enter the collision energy (for SRM methods) in eV. The collision of a precursor ion with the collision gas at a particular energy fragments the precursor ions into product ions. By varying the collision energy, a single precursor ion can be fragmented into several product ions. An SRM transition is defined by a precursor ion being fragmented into a particular product ion mass using a certain collision energy.

31. Use the right-side panel in **Timed Mode** mode to make the following adjustments to your method.

a. Use the **Scan Settings** panel to adjust the following settings. See [Figure 91](#).

**Figure 128.** Timed Mode Scan Settings



i. The **Window Optimization** pane allows access to the window optimizer settings. When the optimize button is checked, acquisition windows will be set automatically based on the acquisition window and dwell time targets set in this pane. For complex SRM or SIM methods, such as a method containing more than three hundred SRM transitions, this option will help insure a method is created that can achieve the requested scans per peak.

Algorithm Details: If the **Optimize** checkbox is checked, the SRM acquisition windows in the method are set to the **Desired Window** unless the **Desired Min Dwell Time** cannot be met with the number of **Requested Scans Per Peak**. If this occurs, then the acquisition windows are reduced until either the **Desired Min Dwell Time** is met, or the **Minimum Window** is reached. If the **Minimum Window** is reached first, the **Minimum Dwell Time** is reduced until the **Requested Scans Per Peak** is achievable. If the absolute minimum dwell time on the instrument, which is 0.5 ms, is reached before the requested points across the peak are achieved, the **Minimum Window** is lowered until the **Desired Scans Per Peak** criteria are met or until the absolute allowed minimum window on the instrument is reached, which is 0.24 min. In this very rare case you must reduce the number of **Desired Scans Per Peak**, increase the **Min Baseline Peak Width**, or reduce the number of transitions contained in your method before you will be allowed to save your method (see [Chapter 7, “Troubleshooting.”](#)).

Settings: **Optimize** is checked by default. When Optimize is checked, you can adjust the settings in the pane to optimize your method. See [Figure 91](#) on [page 95](#). Remove the check from the box if you want to manually input your acquisition windows. The default values for the window optimizer should give reasonable results for normal methods. The default values are:

Desired Min Dwell Time—10 ms

Desired Window—0.6 min

Minimum Window—0.3 min

- Change the minimum dwell time using the **Desired Min Dwell Time** combo box. If your method has many transitions, you may want to reduce the desired minimum dwell time. Note that the wider the acquisition windows in your method, the shorter the average dwell time will be.
- Change the desired acquisition window in the **Desired Window** combo box. The desired window is the amount of time to scan for a transition around a given retention time to ensure that compound will be observed. The desired window can be set from 0.24–5 min. Set the window wide enough so that a retention time shift will not cause you to miss any compounds. Include extra time in this window if there is any uncertainty in compound retention times in the method. Note that the longer the dwell time for your compounds, the narrower your acquisition windows will be.
- Change the minimum acquisition window in the **Minimum Window** combo box. The minimum window can be set from 0.24–5 min. This is the smallest amount of time that should be scanned for a transition around a given retention time so that you are confident the compound will be observed. Set the minimum window to the lowest safe value to prevent compound retention times from drifting outside the acquisition window.

**Note** If the dwell time limit is reached and the minimum acceptable window is forced below the 0.24 min limit, the method will fail, and a smaller list must be used.

- ii. The **Time Summary** section reports the resulting total scan time, the SRM/SIM time, and lowest dwell time for you method. These values are for information only and not editable.
  - The **Resulting Total Scan Time** is the baseline peak width divided by the number of points desired across the peak. These values should be updated if your method requirements are different from the defaults.
  - The **SIM/SRM** time is the total length of all SIM or SRM scans for each compound in your list. This will match the total scan time unless the method also has a full scan event.

- The **Lowest Dwell Time** is the actual lowest dwell time achieved by the method settings. When the **Optimize** check box is selected, if the actual lowest dwell time is considerably lower than the requested dwell time, then the minimum window has been reached, and if the actual lowest dwell time is considerably higher than the requested dwell time, then the requested window has been reached.
- iii. Under **Peak Width**, you can change the minimum baseline peak width and desired scans per peak. These values are used to calculate the SRM/SIM Time. The minimum baseline peak width should be set roughly to the shortest chromatographic peak time in your analysis.
- iv. Under **SRM Resolution**, check the **Set Resolution for Each Unique Transition Scan** checkbox if you want to adjust the Precursor (Q1) Resolution or Product (Q3) Resolution for individual analytes. If this box is not checked, the settings apply to all compounds in the method.
  - Use the **Precursor (Q1) Resolution** column to set the full width at 50% (FWHM) of the precursor mass for SRM scans. The combo-box options are **Normal**, **Wide (1.5 FWHM)**, **Widest (2.5 FWHM)**, or **Custom** for each scan after a precursor mass has been entered. The default setting is Normal, which uses the tuned resolution values from the tune file specified in the **Tune File Name** column. Opening the precursor peak width increases the ion signal into the collision cell, which might improve the sensitivity of your method; however, it may also increase the background noise level. Set Custom width in the tune types. If using the default tune types, Custom width is 1.2 FWHM.
  - Use the **Product (Q3) Resolution** column to set the full width at 50% (FWHM) of the product mass for SRM scans. The combo box options are **Normal**, **Wide (1.5 FWHM)**, **Widest (2.5 FWHM)**, or **Custom** for each scan after a product mass has been entered. If the product mass is removed from a scan to run a SIM or FS scan event, the Product (Q3) Resolution column returns to the default value of Normal, which uses the tuned peak width at 10% or 50% as specified in the Tune File Name column. Selecting Wide (1.5 FWHM) or Widest (2.5 FWHM) increases the product ion peak width to 1.5 and 2.5 amu FWHM respectively, resulting in an increase of ions reaching the detector. The increase in ions at the detector may improve the sensitivity of your method; however, it may also increase the background noise level, as well as introduce isotopic interference from +/- 1 amu ions. Set Custom width in the tune types. If using the default tune types, Custom width is 1.2 FWHM.

**Note** To achieve the highest transition speeds capable on the instrument, the resolution of all transitions must be set to Wide or Widest for both Q1 and Q3 resolution.

**Note** When the window optimizer is activated the **Window**, **Pre-width**, and **Post-width** columns are no longer available in the compound list editor. If your method is linked to a file or imported from a file with values in these columns, the values are stored in memory and can be recovered by deactivating the window optimizer.

- v. Under **Acquisition Options**, select the **Allow for Asymmetric Acquisitions** check box to add extra time to the beginning or end of an acquisition window without affecting other timing in your scan. When you select this option, **Pre-width and Post-width** columns are added to your method. Enter the extra times in these columns.

**Note** This option is only available when the method optimizer is not active.

Select the **Allow Dwell Time Prioritization** check box to increase the dwell times for selected scans. The choices for each scan are **Normal** or **High**. Giving a scan high priority increases its dwell time by the value you set in the **High Priority Multiplier** box.

Select the **Allow Unfiltered Signal** check box for most methods. To improve integration of congeners, the box must be checked. Leaving the box unchecked helps improve the signal-to-noise ratio for resolved chromatographic peaks.

- vi. Under **Full Scan**, you indicate if a Full Scan is to be run along with SIM and SRM. The Mass Range, Scan Time, Start and End Time can be set after the **Use Full Scan** box is checked. The full scan time will reduce the SRM/SIM time without increasing the total scan time. If you only want to use full scan for part of your method, you can enter full-scan start and end times.

**Tip** Click the arrow at the top right of the **Scan Settings** panel to collapse or expand the panel.

- b. Use the options in the **Instrument Settings** panel to further adjust your method.
  - i. Use **Tune File** to select a tune file or files to be used for this scan.
  - ii. In the **Detector Gain** area, set the detector gain. Select the **Use Last Tuned Detector Gain** option to indicate that you want to use the detector gain set in Auto Tune. If you do not need to use the gain set in Auto Tune, then you can set the gain manually. Higher gains give larger signals, but may shorten the lifetime of the detector when concentrated samples are detected. To manually set the detector gain, select the **Use Specified Detector Gain** radio button and enter the desired value in the Detector gain box.
  - iii. Use the **Emission Current** box to set the emission current used during the acquisition. For optimal analytical performance and stability, use the emission current at which the system was tuned. However, if you want to use a different emission current, select the **Use Specified Emission Current** radio button and enter a value in the **Emission Current (µA)** box. A high emission current will lead to the production of more ions, but the interaction of too many ions in the

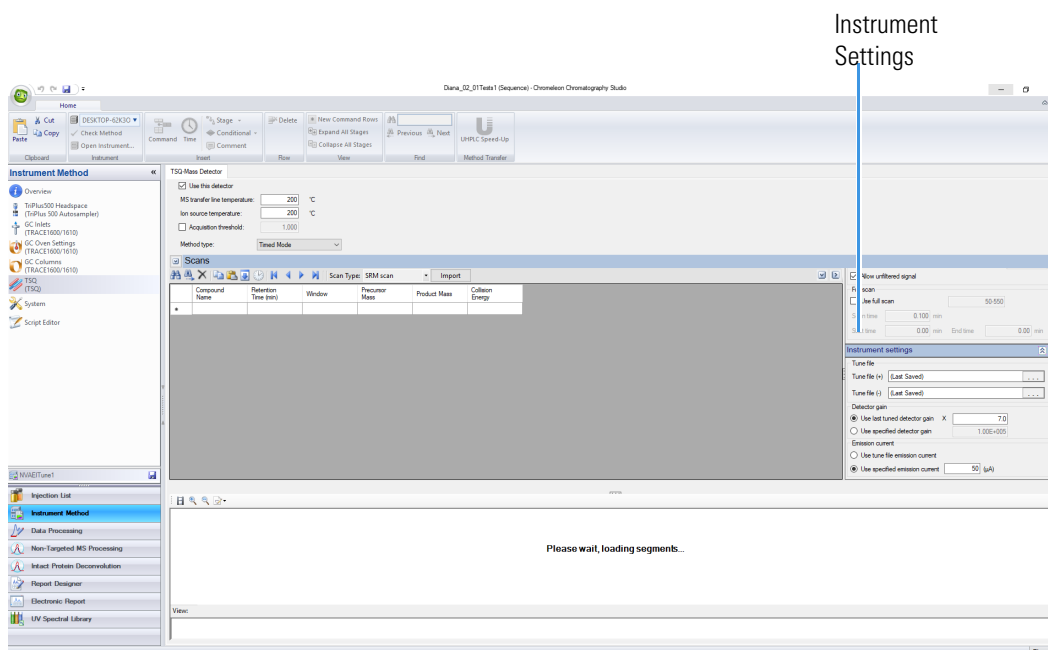
## 4 Creating a Method

### Creating a GC-MS Method in Chromeleon Software

source can cause a degradation in the resolution and signal. The margin of error is  $\pm 0.5 \mu\text{A}$ .

**Tip** Click the arrow at the top right of the **Instrument Settings** panel to collapse or expand the panel.

**Figure 129.** Timed Mode Instrument Settings

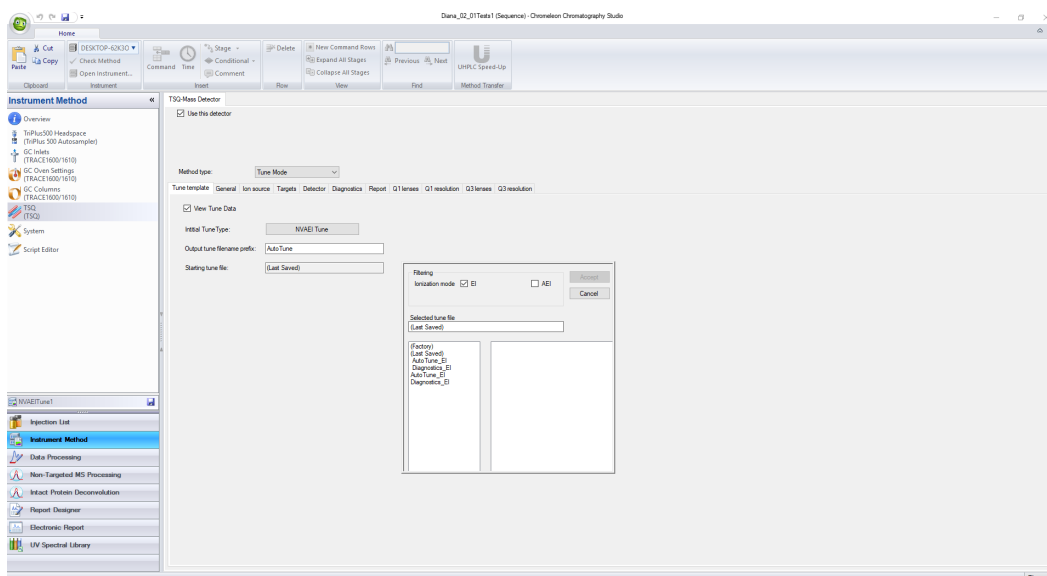


32. Click **Next**.

33. The **Tune** method allows you to run a tune from the method editor.

- From the **Method Type** drop-down box, select **Tune Mode**. See [Figure 130](#).

Figure 130. Selecting a Tune Mode Method

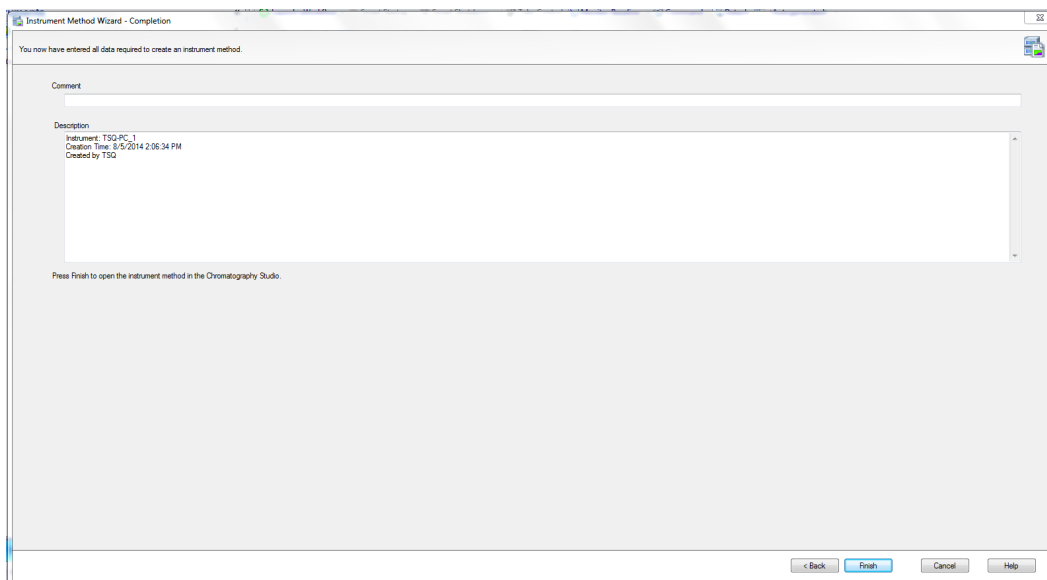


- b. Under **Tune Template** set the following parameters:
    - i. Check **View Tune Data** to view the tune data.
    - ii. **Initial Tune Type**: Set EI, CI, or AEI.
    - iii. **Output Tune Filename Prefix**: Autotune is the default.
    - iv. **Starting Tune File**: The last saved tune is the default.
  - c. Set up the remaining tune parameters in Tune Method as described in [“Tuning” on page 45](#).
34. Click **Next**. The **Instrument Method Wizard – Completion** page opens. See [Figure 131](#).
  35. The Instrument Method Wizard – Completion page opens. See [Figure 131](#).

## 4 Creating a Method

### Creating a GC-MS Method in Chromeleon Software

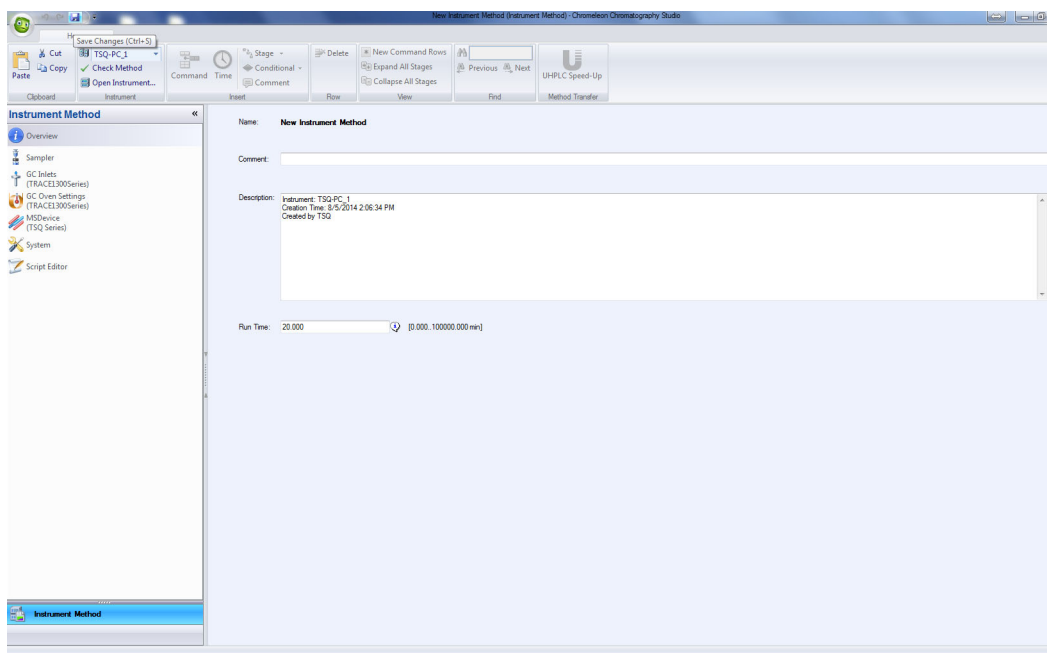
**Figure 131.** Instrument Method Wizard – Completion



36. Enter any comments or notes for your method and click **Finish**.

37. The New Instrument Method (Instrument Method) Chromeleon Chromatography Studio window opens. Click the **Save** icon to save your method. See [Figure 93](#).

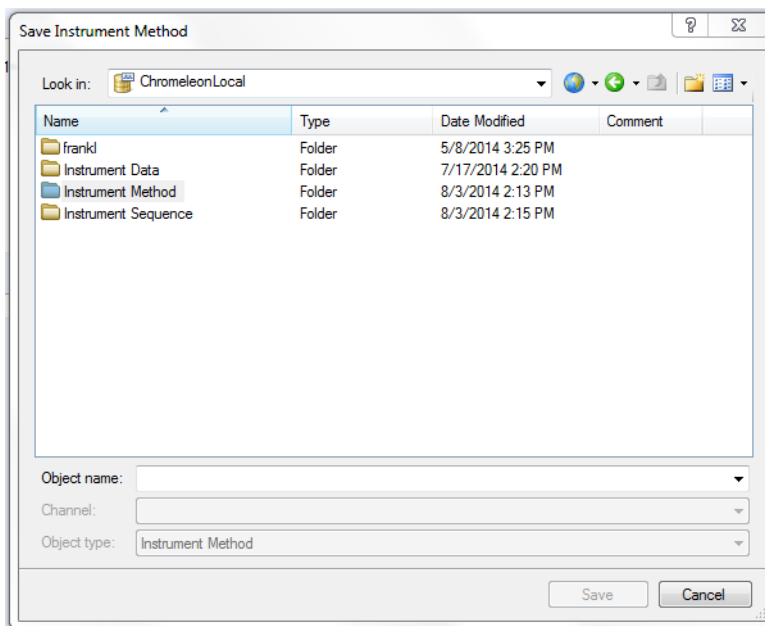
**Figure 132.** Saving Methods



38. The Save Instrument Method dialog box opens. Save your method in Chromeleon Local > Instrument Method. See [Figure 133](#).

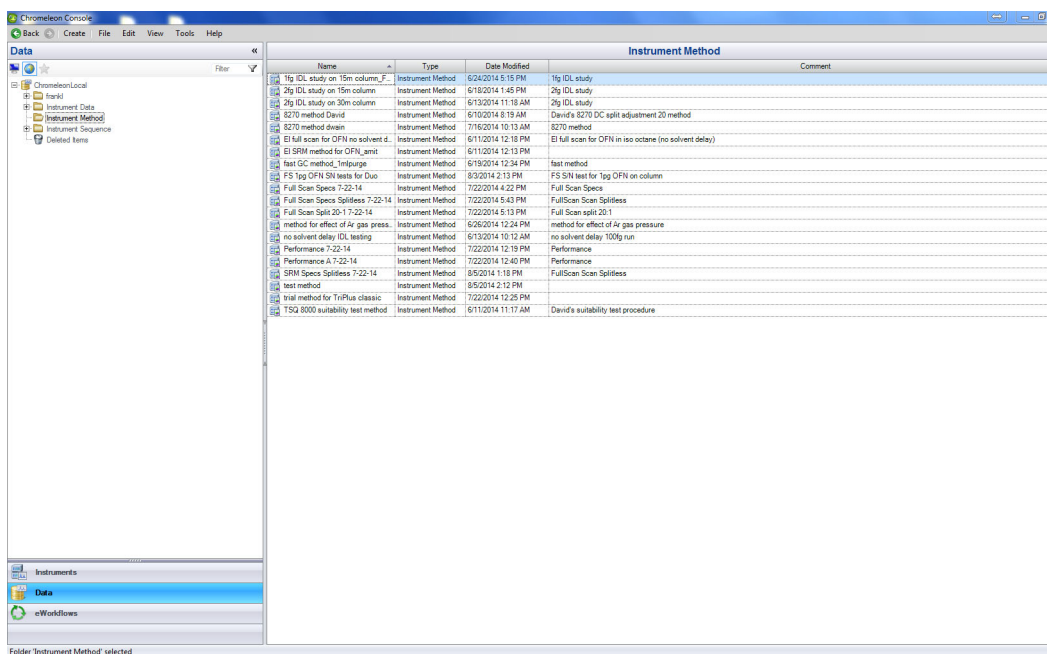


Figure 133. Finding the Instrument Method Folder



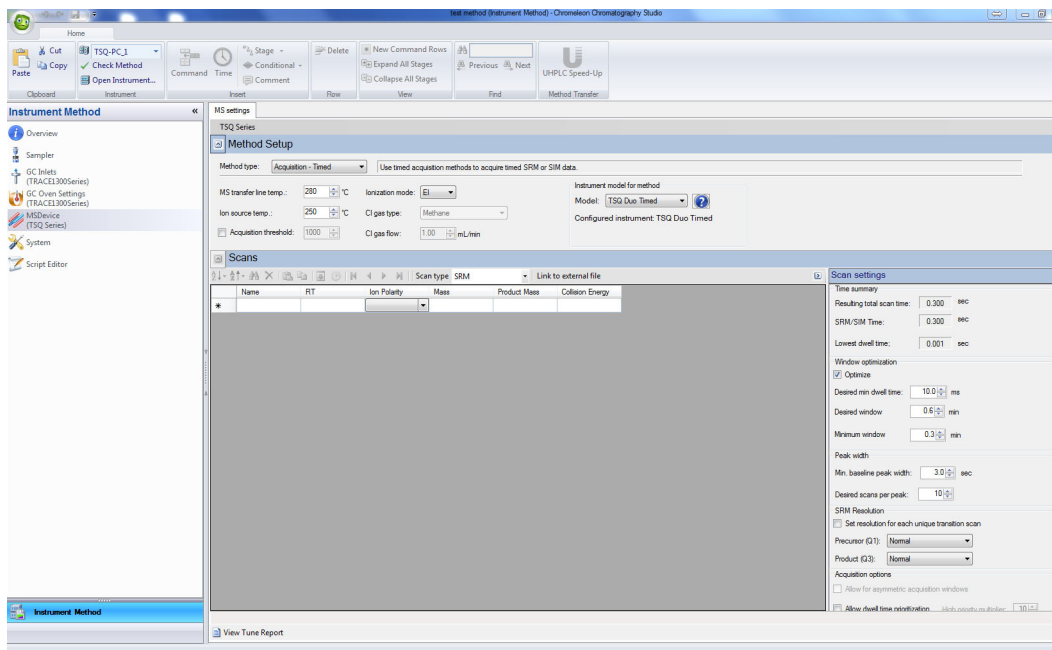
39. Enter your method in the **Object Name** box and click **Save**. Your method is now saved.
40. You can view all instrument methods on your system by opening the Chromeleon Console and selecting **Data** from the left menu. See Figure 134.

Figure 134. Viewing all Instrument Methods




41. To edit a method, select it from the list. The method opens in the Chromatography Studio. See Figure 135.

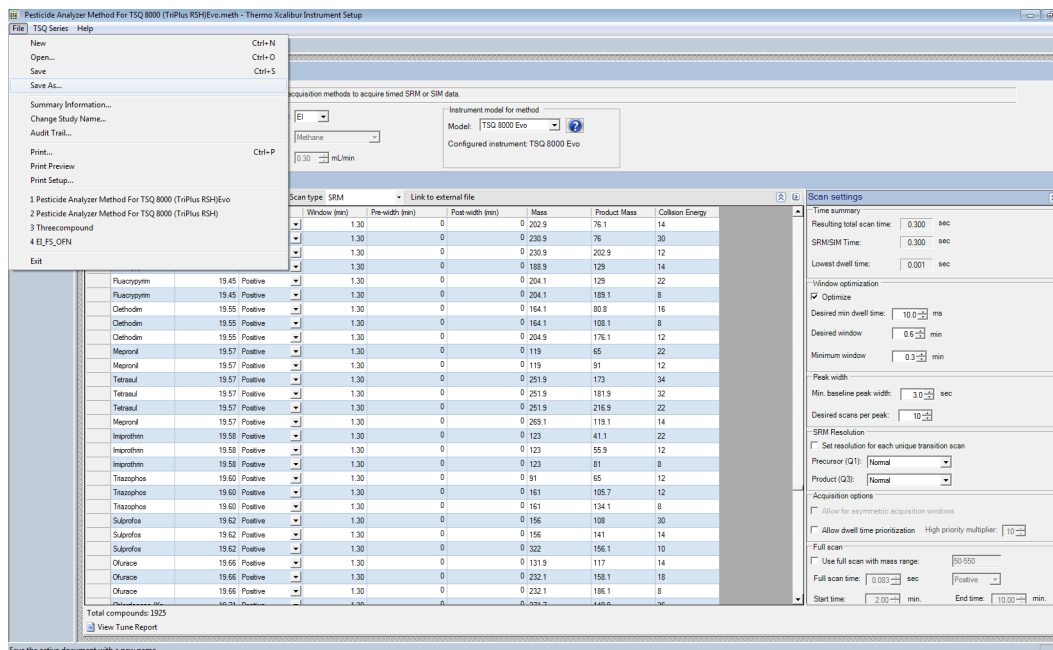
Figure 135. Editing a Method



42. Select a device from the left menu and edit its parameters as described in this chapter.

43. When you are finished creating methods for each component in your GC/MS-MS system, choose **File | Save As...** from the main menu or click the  button.

**Figure 136.** Saving a Method

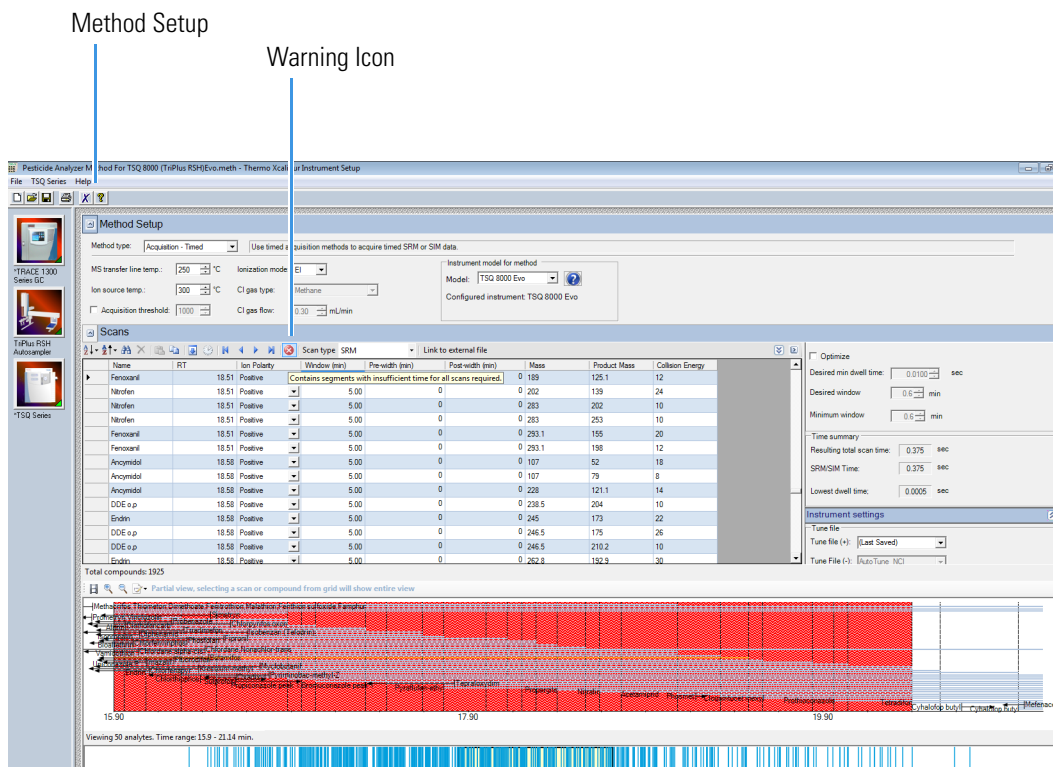


## Validating and Troubleshooting Methods

The window optimizer was created in part to avoid cases where the number of compounds and the width of SRM acquisition windows requested are incompatible with the number of points requested per peak. Although using the window optimizer will avoid most of these problems, extreme cases still exist where your method will fail to validate. In these cases, you can fix this by reducing the desired scans across the peak, reducing the number of scan events, or, if the window optimizer is not selected, by reducing the acquisition windows.

If your method will not validate, a red error icon appears in the **Scans** pane and an error message that reads **Contains Segments with Insufficient Time for All Scans Required** appears if you try to save the method. [Figure 137](#) illustrates an unvalidated method.

**Figure 137.** Viewing the Analytes

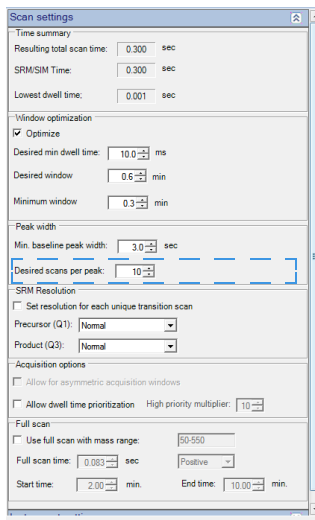


If orange bars are present, you will get less than the desired scans across the peaks. You can fix this by reducing the desired scans across the peak, reducing the number of scan events, or reducing the acquisition windows, and the resolution will be lower than expected from your method.

❖ **To decrease the desired scans per peak**

- In the **Scan Settings** area, reduce the number of scans in the **Desired Scans Per Peak** box. See [Figure 138](#).

**Figure 138.** Reducing the Desired Scans Per Peak



The method optimizer allows the acquisition window to be reduced by reducing the desired window or the minimum acceptable window. If you see a yellow warning icon, the optimizer is at the minimum acceptable window. Deactivating the method optimizer and reducing this value may resolve the issue.

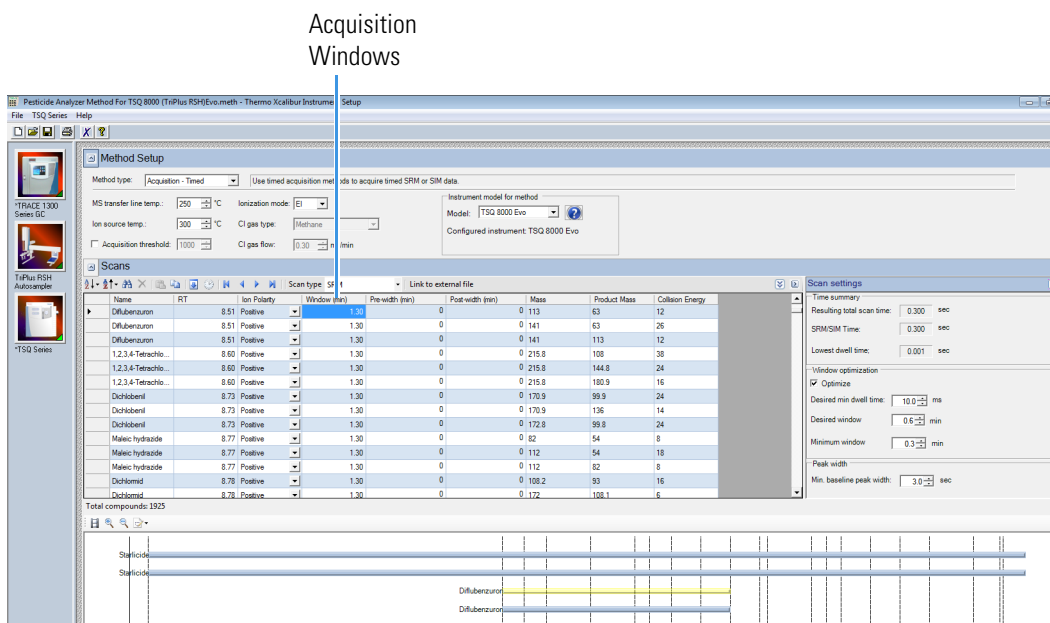
If you see a red error icon, the window will be at the absolute minimum limit and the only way to resolve the error is to remove transitions, reduce the number of points across the peak, and/or ensure that the baseline peak width is set appropriately.

❖ **To reduce the acquisition windows**

**Note** The method optimizer must be deactivated to perform the following troubleshooting activities.

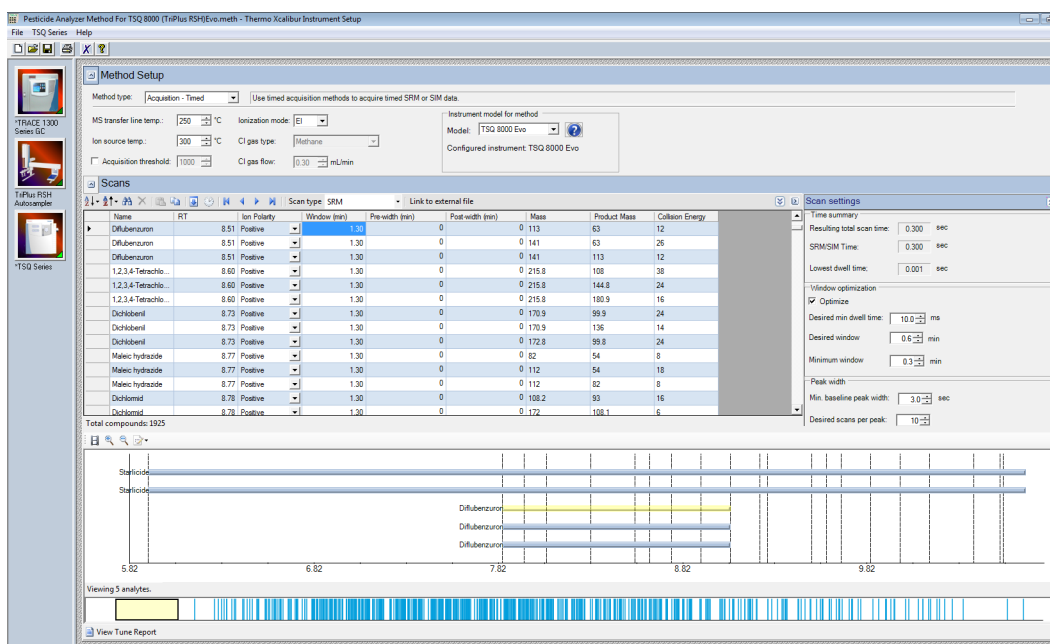
1. In the Scans pane, go to the first problem analyte and click on the **Window (min)** column. See [Figure 139](#).
2. Decrease the time.
3. While holding down the shift key, click the last problem analyte in the list.
4. Go back to the first analyte you selected, right-click, and choose **Fill Down**.
5. If the red error icon still appears, and your method allows it, reduce the acquisition windows further.

Figure 139. Reducing the Acquisition Windows



When your method validates, the warning icon and the red bars disappear from the method editor. See Figure 140.

Figure 140. Validated Method



You may now save the method as described earlier.

## Optimizing Your Method

If you are not getting the expected results from your method, you can modify it using the following procedures for better results.

### Contents

- [Changing the Chromatographic Separation](#)
- [Finding the Best Way to Make an Injection](#)
- [Improving the Way You Prepare Samples](#)
- [Changing the Dwell Time or Scan Rate](#)
- [Narrowing the Mass Range](#)
- [Adjusting the Transfer Line and Ion Source Temperature](#)
- [Optimizing an SRM Method](#)
- [Optimizing an NCI Tune](#)
- [Modifying an Automatic Tune](#)

## Changing the Chromatographic Separation

Peak shapes are defined by the chromatographic conditions. If your peak is too wide, too narrow, or not symmetrical enough, then changing the chromatographic conditions are the best way to improve your method. Start by changing the GC carrier gas flow or oven temperatures (the initial temperature, initial hold time, ramp temperature, final temperature for that ramp, and hold time at that final temperature). These temperatures can be adjusted for each ramp.

Oven changes are strongly dependent on the nature of the compounds you are analyzing. At some point, the GC oven has to be above the boiling point of the compounds you are looking for. If the GC oven is not at the boiling point, the compounds will not volatilize and they will become immobilized. You can change ramp rates to separate coeluting peaks. Refer to the GC user documentation for further suggestions on optimizing chromatographic separation.

# Finding the Best Way to Make an Injection

Adjusting the way you get the sample from the needle into the column can sometimes improve the results of your data. Try modifying the autosampler method, injecting a different amount of liquid, adjusting the injector port temperature or flow, or changing the speed of your injection. You can also try using a hot or cold needle injection. In some cases, adjusting your injection port liners may give you better results. (For detailed instructions, refer to the user guide for your autosampler.)

# Improving the Way You Prepare Samples

Although sample preparation adds time and expense to the overall analysis, a more focused method can give you better results. Try extracting your sample in a solvent that increases the solubility of the analytes of interest, but does not increase the solubility of the other compounds. If your method allows it, try switching solvents.

You can also use or change the phase of a solid phase extraction cartridge, which gives you similar results as changing a solvent. You can affect the way you prepare samples by changing the type of cartridge you are using.

# Changing the Dwell Time or Scan Rate

The precision of your data depends on how well you define your chromatographic peak. Typically, you get good precision when sampling ten times across the chromatographic peak. In a full scan analysis, increasing the scan rate increases the number of times you have sampled across the peak. However, increasing the scan rate too much results in mass spectral noise, which decreases your analytical precision.

In a SIM or SRM analysis, reducing the dwell time will have a similar effect to increasing the scan rate in full scan. The dwell time is a measure of how long the instrument will average a SIM or SRM event. To optimize your scan rate or dwell time, select a value that gives you 8-12 points across a chromatographic peak. In timed acquisition mode this optimization is done automatically, providing you with the longest dwell time or slowest scan rates possible such that all compounds receive the desired scans across a chromatographic peak.

### ❖ To prioritize the dwell times of the problem analytes

1. In the Acquisition Options area, check Allow Dwell Time Prioritization. See [Figure 141](#).
2. Set the High Priority Multiplier to the desired value.
3. A new Dwell Time Priority option appears in your scan list. The choices are Normal or High. Choosing High multiplies the dwell times by the value set in the previous step.



**Note** The total scan time does not change. If prioritizing some dwell times reduces others to less than the lowest allowed dwell time for your method, try increasing the acquisition windows.

**Figure 141.** Setting the Dwell Time Prioritization

The screenshot displays the 'Method Setup' window for a TSQ 8000 instrument. The 'Scans' table is the central focus, listing 1925 total compounds. The table columns include Name, RT, Ion Polarity, Window (min), Pre-width (min), Post-width (min), Mass, Product Mass, Collision Energy, and DwellTimePriority. The 'DwellTimePriority' column shows values like 'Normal', 'High', and 'Lowest'. The 'Scan settings' panel on the right includes a 'Time summary' section with 'Resulting total scan time: 0.300 sec' and 'SRM/MSM Time: 0.300 sec'. It also features 'Window optimization' options such as 'Desired min dwell time: 10.0 ms', 'Desired window: 0.5 min', and 'Minimum window: 0.3 min'. The 'Acquisition options' section is checked for 'Allow dwell time prioritization' with a 'High priority multiplier' of 10.

## Narrowing the Mass Range

In a full scan analysis, by narrowing your mass range, you can look directly at the compounds of interest. However, if you are looking at a large number of compounds that have a broad range of mass fragments, a wide mass range makes sense. To narrow the mass range, refine your scan parameters to a smaller number. A narrower mass range also allows you to decrease the scan rate and get the same chromatographic peak sampling. By breaking your MS method into groups, you can create compound-specific MS settings to optimize your data.

## Adjusting the Transfer Line and Ion Source Temperature

If your transfer line temperature is set too low, the less volatile compounds may get stuck in the transfer line and never make it into the ion source. On the other hand, if your transfer line is too hot, you could damage the column or cause a thermal breakdown in the compounds you are analyzing. Typically, aim for the transfer line temperature to be 10 °C (18 °F) over the highest boiling point of the compounds of interest, but no higher than the maximum safe operating temperature of the column.

Use the highest ion source temperature setting that allows adequate response for targeted analytes in order to improve response for high-boiling compounds and prevent column bleed and matrix compounds from dirtying the ion source.

**Note** The transfer line temperature and ion source temperature should be similar to avoid contaminating the ion source.

## Optimizing an SRM Method

The following actions might improve your results when using an SRM method:

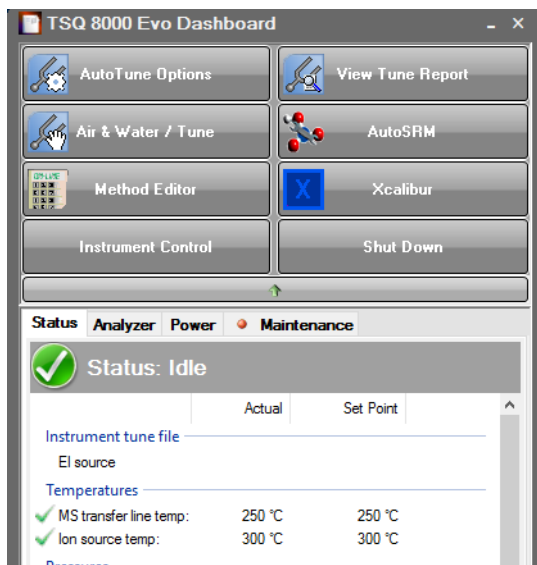
- Use timed SRM to optimize segments automatically and possibly improve dwell time and number of points across the peak.
- Reduce the Retention Time window if possible. If your sample's retention time is well known the scan window can be reduced. If this is in a high-density compound area it can dramatically improve the ion signal and number of points across the peak.
- Use AutoSRM to optimize collision energy and retention times. This can reduce errors in collision energy and improve confidence in retention times to allow shorter windows.
- Choose the optimum fragment ion for study if allowed by your method. Some fragments are higher in intensity and have less interference associated with their transition.

## Optimizing an NCI Tune

Use the following workflow to adjust the low mass when you create an NCI tune.

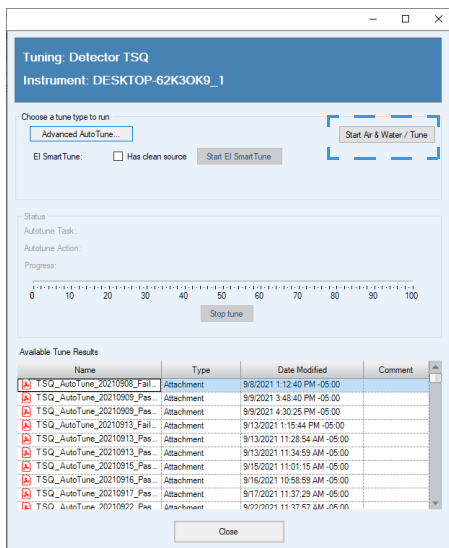
1. If you are running Xcalibur software, click **Air & Water/Tune** on the TSQ Series Dashboard to find TSQ Manual Tune. See [Figure 142](#).

**Figure 142.** Finding Manual Tune on the TSQ Series Dashboard



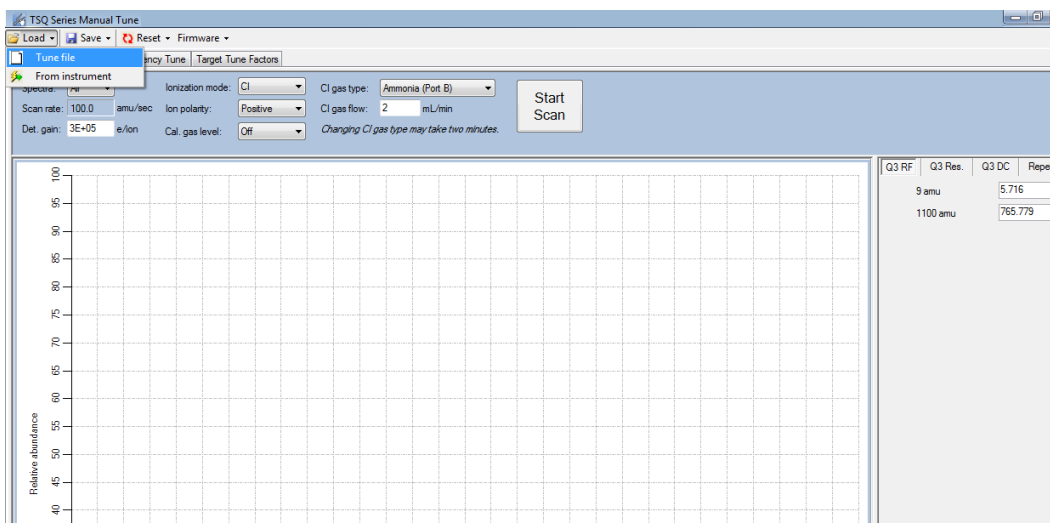
2. If you are running Chromeleon software, click Tuning on the console page to open the TSQ tuning utility. Then click **Start Air & Water/Tune**. See [Figure 143](#).

**Figure 143.** Finding Manual Tune in Chromeleon Software



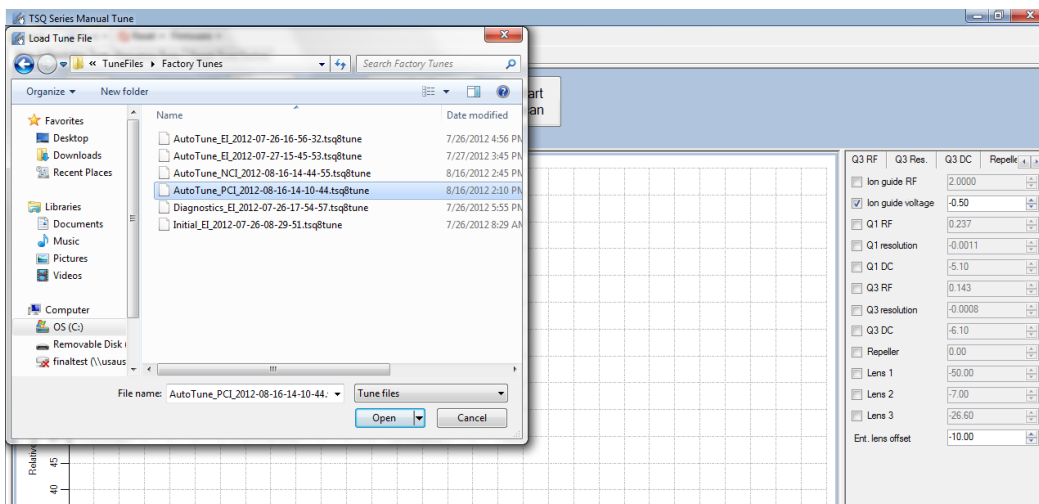
3. Go to **Load | Tune File** to access the manual tune files.

Figure 144. Accessing Manual Tune Files



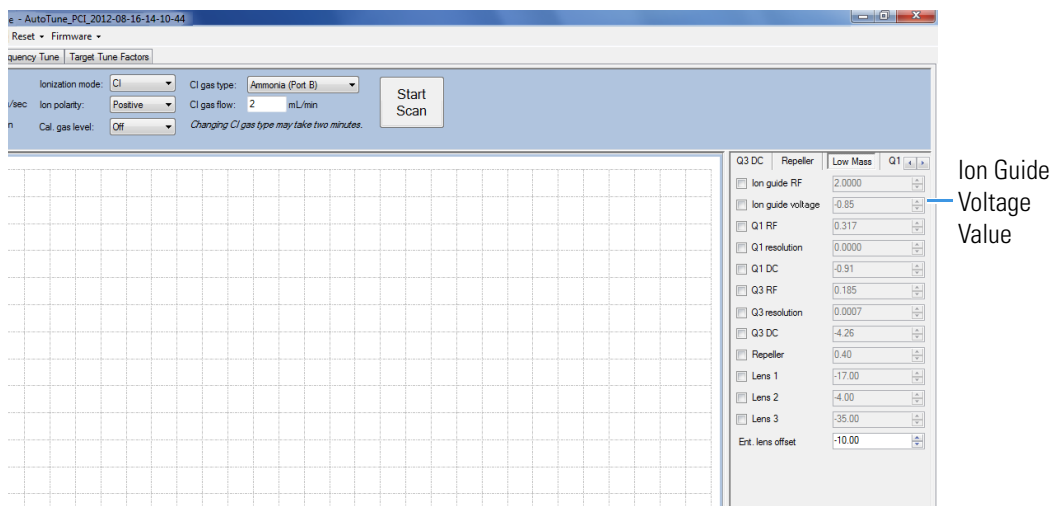
4. The **Manual Tune Files** dialog box opens. Select a PCI Tune file.

Figure 145. Loading a PCI Tune File



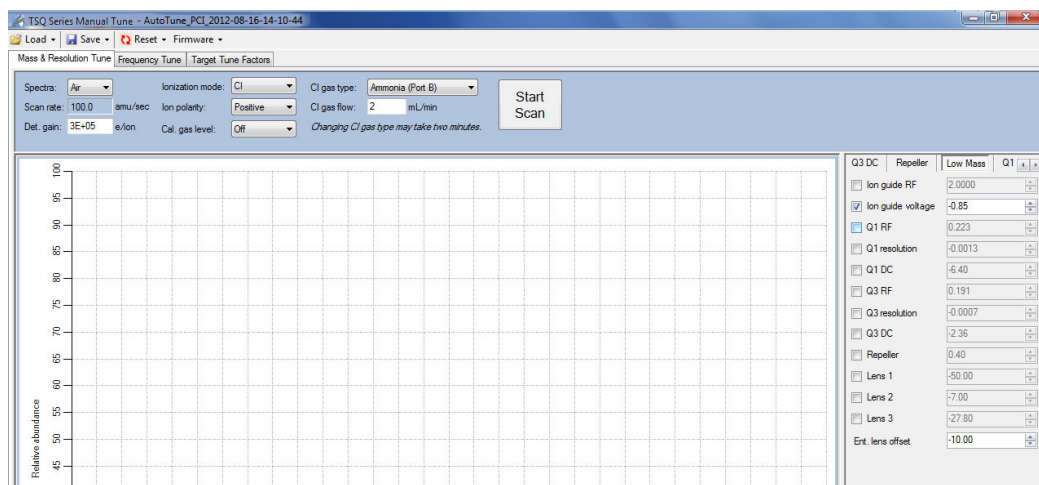
5. Select the **Low Mass** tab on the right. Note the ion guide voltage value.

Figure 146. Finding the Ion Guide Voltage Value



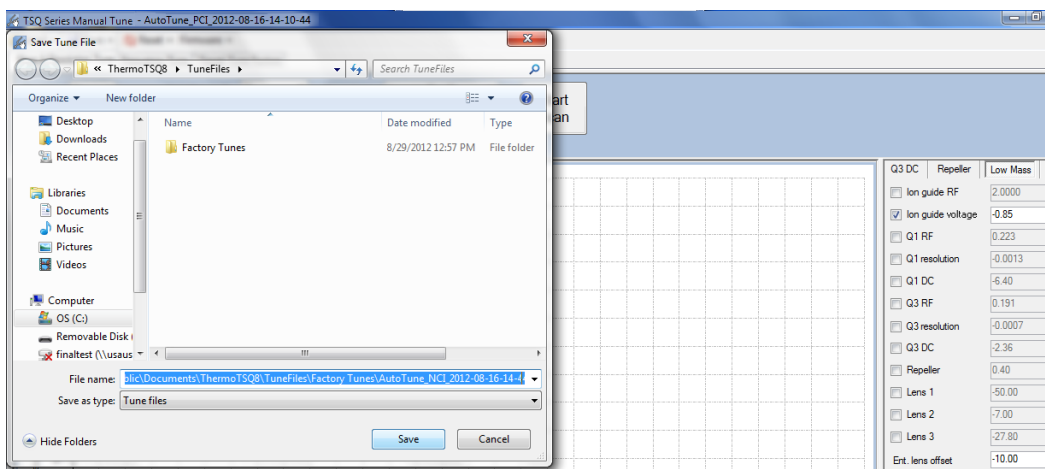
6. Load an NCI tune file from Manual Tune.
7. Click the **Ion Guide Voltage** box under the **Low Mass** tab to activate it.

Figure 147. Activating the Ion Guide Voltage in a NCI Tune File



8. If the ion guide voltage value is positive, change it to the PCI value you recorded earlier, which should be negative. You may also optimize the ion guide voltage value to any other negative value.
9. Save the changes to the tune file or rename it and save it as a new file.

Figure 148. Saving a New NCI Tune File



10. Click **Save**.
11. Close Manual Tune.

❖ **To optimize the CI ion volume position using methane**

Ion volume placement is the most important setting for CI. Your instrument's sensitivity is maximized when the ion volume electron hole is properly cleaned inside and outside, but this sensitivity rapidly decays until the hole gets an ion burn. This is normal behavior for your instrument. Lower emission currents cause this decay to happen less rapidly.

1. Scan reagent gas ions in methane PCI in manual tune, making note of the reagent gas intensities for ions at  $m/z$  29 and 41. To do this, select **Air** for the spectra or one SIM mass 35, width 50.
2. Remove the source and rotate the ion volume in the sleeve and reinsert, repeating until you get the highest  $m/z$  29 for the current flow and filament settings.
3. Once the orientation of the ion volume is optimized, if you are tuning in PCI, adjust the methane flow so that the  $m/z$  41 greater than 20% of 29 at 50  $\mu\text{A}$  and 70 eV. If you are tuning in NCI, use a flow between 1 and 1.5 mL/min methane for most analytes.
4. Perform full scan NCI with the calibration gas on and optimize the repeller voltage. On some instruments a value of 0.5 to 1 V will generate good ion flux while almost no ions will be observed at 0 V. This is due to a possible positive offset of a few tenths of a volt on the repeller electronics.
5. Save the tune file with the appropriate name or save the tune file to the instrument to begin the automated tune.

**Note** You may also adjust the emission current for the ionization mode and samples. The higher emission currents often work better in NCI, and the lower emission currents often work better in PCI but the optimal emission currents are typically between 25-100  $\mu\text{A}$ .

## Modifying an Automatic Tune

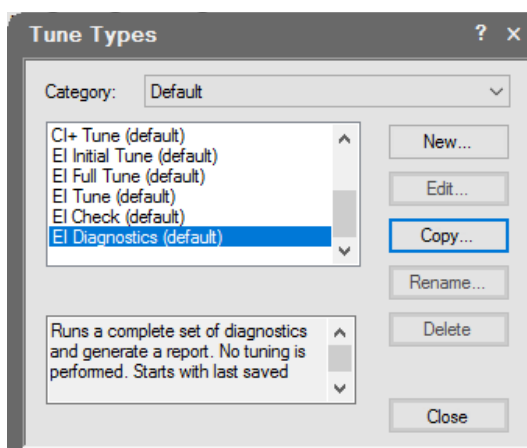
The MS instrument control software includes a utility that uses certain parameters in the tune types to optimize system performance when generating a tune file. Follow these procedures:

- To modify an automatic tune in Xcalibur software
- To modify advanced tune settings in Xcalibur software
- To modify an automatic tune in Chromeleon software
- To modify advanced tune settings in Chromeleon software

### ❖ To modify an automatic tune in Xcalibur software

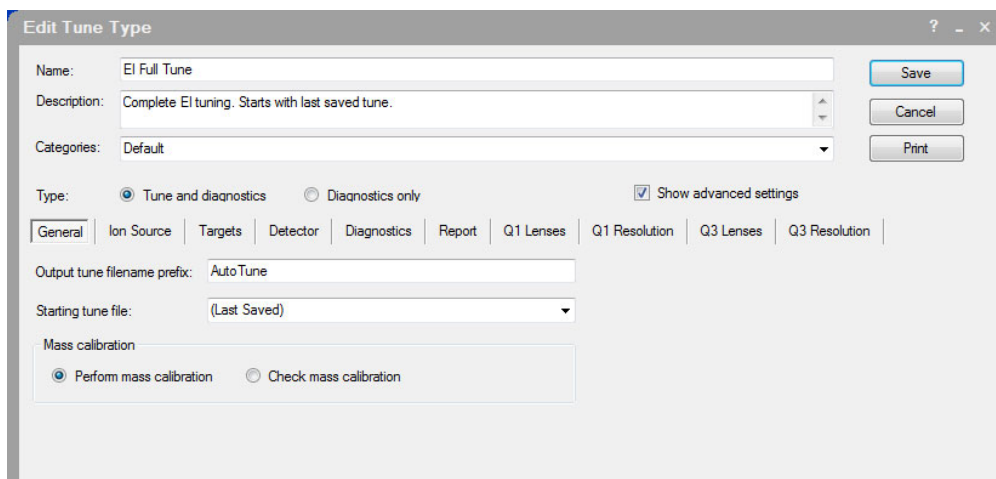
1. Open the TSQ Series Dashboard and click **Tune Types**.
2. In the **Tune Types** dialog box, select a tune type to edit and click **Copy**. See [Figure 149](#).

**Figure 149.** Tune Types Dialog Box



3. The **Tune Type Editor** opens. Configure the parameters under the **General** tab in the Tune Type Editor. See [Figure 150](#).

Figure 150. Configuring General Tuning Parameters



- a. **Name**—Enter a name for your tune type.

**Note** Create the new tune type name now. You will not be able to edit the tune type name later. Also, you will not be able to save new parameters to a built-in tune.

- b. **Description**—Enter details or notes about your tune type.
- c. **Categories**—This is an optional field that allows you to display a subset of tunes under Auto Tune on the dashboard. This is convenient for separating your most frequently used tunes.
- d. **Type**—Select the **Tune and Diagnostics** option to run a tune with diagnostics or select the **Diagnostics Only** option if you are creating a diagnostics test.
- e. **Output Tune Filename Prefix**—Enter a prefix to be added to the title of your tune report. It is a good idea to use a descriptive prefix for your tune type. For example, if you are always running BFB reports, you could enter BFB here to distinguish it from other reports you are generating.
- f. **Starting Tune File**—Select a tune file that your tune type will be based on:

**Note** If you select a tune file with a prefix-only name rather than a tune file with a date-time stamp, the most recent tune file of with that prefix name will be loaded at the start of each tune.

- Select **Factory** to use a default factory-made file on the instrument that can be used to begin tuning an instrument with a clean ion source.
- Select **Last Saved** to use a tune file saved on the instrument by the most recent successful automatic tune.
- Select a specific tune file if you have a reliable tune file you want to use as a starting point for a new tune file.



- g. **Perform Mass Calibration**—Select this to enable the system to recalibrate all of the masses during a tune.
- h. **Check Mass Calibration**—Select this to enable the system to confirm that your mass calibration is correct rather than performing a mass calibration.

**Note** If Tune and Diagnostics is selected, you can select only one Mass Calibration option.

4. Select the **Ion Source** tab to configure the ion source parameters. See [Figure 151](#).

**Figure 151.** Configuring the Ion Source Parameters

The screenshot shows the 'Edit Tune Type' dialog box with the following settings:

- Name: EI Full Tune
- Description: Complete EI tuning. Starts with last saved tune.
- Categories: Default
- Type:  Tune and diagnostics,  Diagnostics only
- Show advanced settings:
- General | **Ion Source** | Targets | Detector | Diagnostics | Report | Q1 Lenses | Q1 Resolution | Q3 Lenses | Q3 Resolution
- Ionization mode & ion polarity: EI+
- Using AEI Source:
- CI gas type: Methane
- CI gas flow: 0.3 mL/min
- Emission current: Default, 50 μA
- Electron energy: Default, 70 eV
- Electron lens positive voltage: Default, 5 Volts
- Electron lens negative voltage: Default, -75 Volts
- Set ion source temperature:  250 °C

- a. **Ionization Mode & Ion Polarity**—Use this pull-down menu to select a mode:
  - Select **EI +** to run a tune in Electron Ionization (EI) mode.
  - Select **CI+** to run a tune in Chemical Ionization (CI) mode and positive ions.
  - Select **CI-** to run a tune in CI mode and negative ions.
- b. **Using AEI Source**—Select if you have an AEI Source installed and want to edit an EI tune.
- c. **CI Gas Type** (only enabled if you select CI+ or CI-)—Use this pull-down menu to select a gas type, but make sure your selection is the reagent gas attached to your system and that the correct gas port is selected. Methane is commonly used for CI+. Other gases will change the efficiency and energy of the ionization process.

**Note** When changing CI gas types or gas port, there is a two minute delay while the reagent gas is purging. During this time, the Busy light will be lit and you will need to wait until the light goes off before using the software.

- d. **Emission Current**—Defines the emission current that you use to run subsequent tunes, but not the emission current that is used for data acquisition. Lowering the emission current can extend the time between required cleaning of the ion source and replacement of the filament as well as extend the life of the detector.
- **Tune File**—Select this option to use the value in the tune file that you selected on the General tab.
  - **Default**—Select this option to use the default emission current, which is 50  $\mu\text{A}$  for EI systems and 10  $\mu\text{A}$  for AEI systems.
  - **Custom**—Select this option if you want to use an emission current other than the default value to increase or decrease the sensitivity of the instrument. Tune with the same value you are planning to use for your analysis. The use of emission currents above 100  $\mu\text{A}$  may lead to the generation of too many ions in the source and a degradation in resolution.
- e. **Electron Energy**—Indicates the energy of the electrons emitted by the filament.
- **Default**—Select this option to use the default electron energy, which is 70 eV for the EI ion source and 50 eV for the AEI ion source.
  - **Tune File**—Select this option to use the value in the tune file you selected in the General tab.
  - **Custom**—Select this option to set the energy of the electrons emitted by the filament. Changing the electron energy affects the ionization efficiency and fragmentation of the sample. This is typically set to 70 V with the EI ion source because the standard EI libraries are based on 70 eV electron beams.
- f. **Electron Lens Positive Voltage**—Allows the electrons to enter the ion volume.
- **Default**—Select this option to use the default electron lens positive voltage, which is 5 V.
  - **Tune File**—Select this option to use the value used in the tune file that you selected on the General tab.
  - **Custom**—Select this option if you do not want to use the default value for the tune. For the electron lens positive voltage, the default is 5 V. You should tune with the same value you are planning to use for your analysis. This value affects the focusing of the electron beam into the source. If you change your electron energy from 70 eV, this value also changes. This voltage must always be at least 45 V above the voltage applied to the filament in order for the instrument software to allow the filament to be turned on. The voltage applied to the filament is the same number, but the opposite sign, of the electron energy. The settable range is 0–150 V.

**Note** When using the AEI source, this lens acts as an ion repeller, so setting a higher value may make it more difficult to pass resolution tuning. Values above 7 to 10 V are not recommended for the AEI source.

g. **Electron Lens Negative Voltage.**

- **Default**—Select this option to use the default electron lens negative voltage, which is  $-75$  V.
- **Tune File**—Select this option to use the value used in the tune file that you selected on the General tab.
- **Custom**—Select this option if you do not want to use the default value for the tune. For the electron lens negative voltage, the default is  $-75$  V. Tune with the same value you are planning to use for your analysis. This value affects how well the electrons are kept from entering the ion source when they are not supposed to. If you change your electron energy from 70 eV, this value also changes. Ensure this voltage is at least 5 V below the voltage applied to the filament.

- h. **Set Ion Source Temperature**—Select this check box to enable the temperature field. Then enter a value between 0 and 350 °C. The default is 200 °C. The optimal temperature is determined by the molecular structure and weight of the compounds you are analyzing. Heavier compounds require a higher temperature. Tune at the same temperature you will use to run your samples. You should set the temperature as high as possible to keep the ion source clean and maintain the right amount of sensitivity. In general, it is advisable to set the ion source temperature higher than the transfer line temperature.

**Tip** If you tune regularly between running sample sets, you can save time waiting for the temperatures to equilibrate by setting the tune temperatures to the same temperature used in your acquisition method.

5. Click the **Targets** tab to configure how you want to tune your targets. Target tuning is used to adjust the way the mass spectrometer tunes to meet regulatory requirements. Otherwise, this is an optional setting. See [Figure 152](#).

Figure 152. Configuring Tuning Targets

The screenshot shows the 'Edit Tune Type' dialog box with the 'Targets' tab selected. The 'Name' field is 'EI Full Tune', the 'Description' is 'Complete EI tuning. Starts with last saved tune.', and 'Categories' is 'Default'. The 'Type' is set to 'Tune and diagnostics' with 'Show advanced settings' checked. The 'Targets' tab is active, showing a table of target ion ratios.

Target mass	Ratio	
50 amu:	1.1	% (25 to 51.5 amu)
69 amu:	100	% (51.5 to 78.5 amu)
131 amu:	90	% (78.5 to 132.5 amu)
219 amu:	70	% (132.5 to 220.5 amu)
414 amu:	2	% (220.5 to 415.5 amu)
502 amu:	1.3	% (415.5 amu and above)

**Tune Target Ion Ratios**—Select this check box to adjust the ratios based on the results from an injection of tuning compound.

6. Click the **Detector** tab to configure the detector. See [Figure 153](#).

Figure 153. Configuring the Detectors

The screenshot shows the 'Edit Tune Type' dialog box with the following settings:

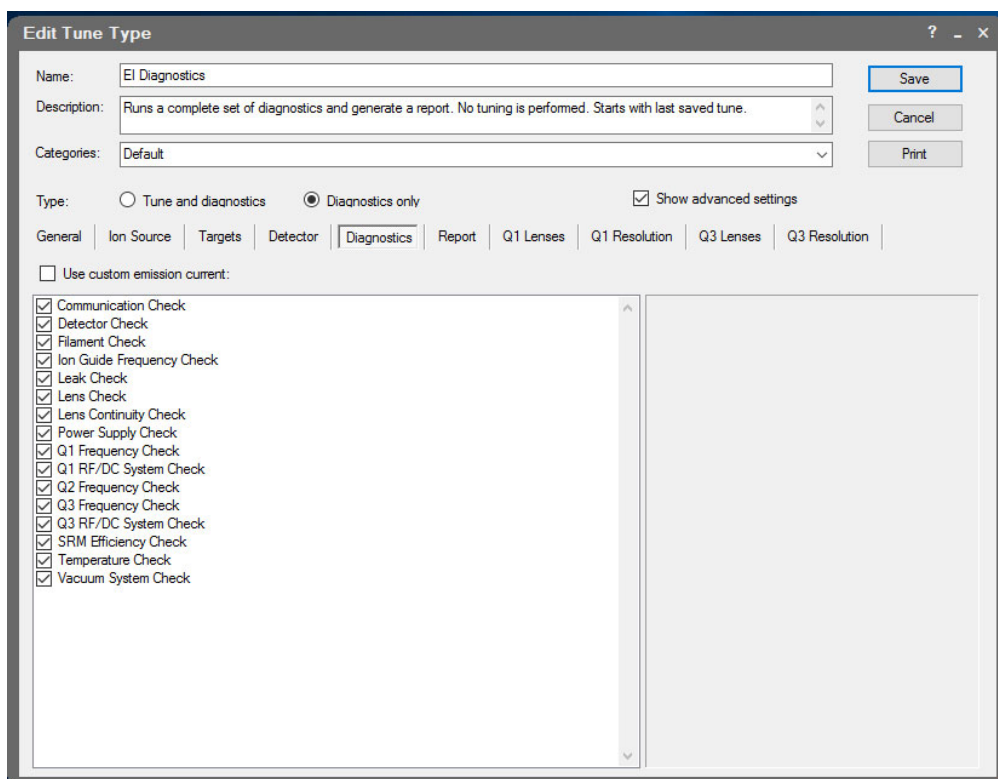
- Name: EI Full Tune
- Description: Complete EI tuning. Starts with last saved tune.
- Categories: Default
- Type:  Tune and diagnostics,  Diagnostics only
- Show advanced settings:
- General | Ion Source | Targets | **Detector** | Diagnostics | Report | Q1 Lenses | Q1 Resolution | Q3 Lenses | Q3 Resolution
- Set initial detector gain: 3 × 10<sup>5</sup>
- Tune detector
  - Use custom emission current: 50 μA
- Adjust detector sensitivity
  - Mass: 219
  - Intensity: 20,000,000

- Set Initial Detector Gain**—Select this option to set the electron multiplier gain that will be used in tuning the instrument. The gain is the number of electrons generated for every ion that strikes the detector. This is typically set at  $3 \times 10^5$  electrons per ion. Gains larger than this will generate more electrons per ion, but both the analyte ion and the noise ion signals will be larger. You can also tune to lower gain values, which decreases the signal strength. Lower values also increase the chance that an ion will not be detected. Detector gains other than  $3 \times 10^5$  electrons per ion are not recommended for use in tuning.
- Tune Detector**—Select this check box to tune the detector. As the electron multiplier ages, the voltage required for a given gain increases. Depending on your sample load and if your system is leak tight (oxygen is bad for the detector), you should not have to perform this tune very often. Limit to 1–2 times a year.
- Use Custom Emission Current**—Select this option to use a custom emission current when tuning the detector. If this feature is not selected, the tune will use the emission current set in the **Ion Source** tab. Reducing the emission current when tuning the detector can help keep the ion source clean and extend the life of the electron multiplier, especially if there is an AEI source installed on the system.
- Adjust Detector Sensitivity**—Select this check box to tune the detector to generate a consistent area count of a calibration gas ion for the tune report. Because the intensity of the cal gas varies depending on the atmospheric pressure and temperature of the lab, this option results in larger variation in the analytical runs, as compared to using

a fixed detector gain. If you use this function, set the initial detector gain to  $3 \times 10^5$  electrons per ion.

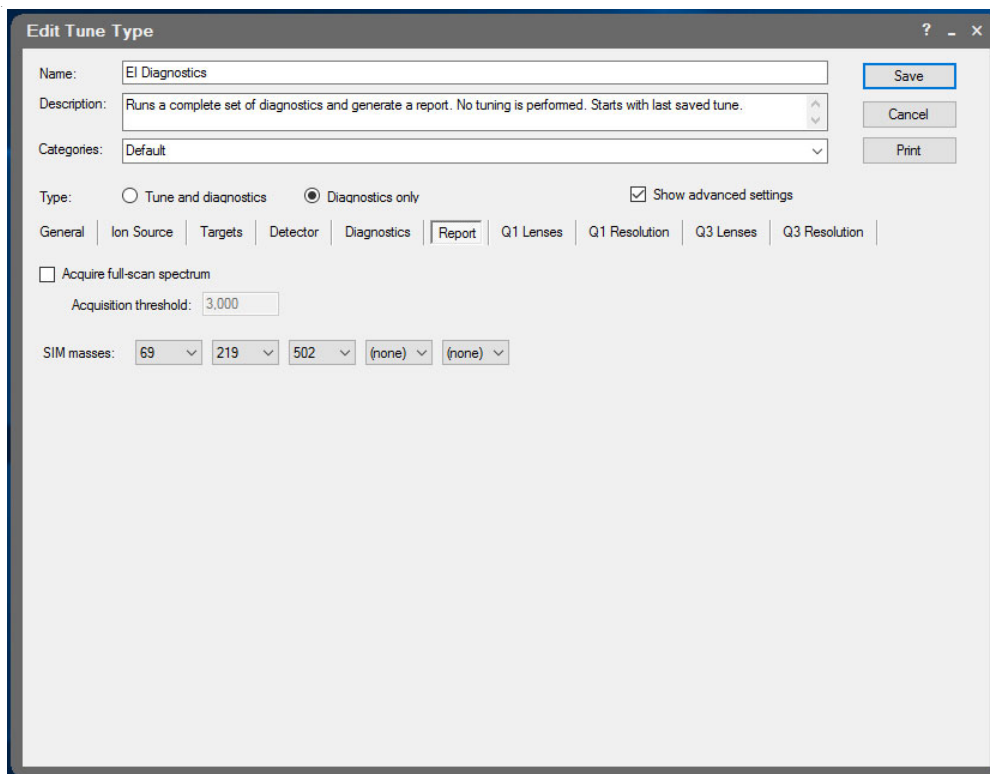
- **Mass**—Select the calibration gas mass you want to use.
  - **Intensity**—Enter the intensity you want to see on the tune report.
7. Click the **Diagnostics** tab and select a test to confirm the operational ability of the system. See [Figure 154](#).

**Figure 154.** Setting Diagnostics



8. Click the **Report** tab configure how you want to view your data. See [Figure 155](#).

**Figure 155.** Selecting Data Report Options



- a. **Acquire Full-Scan Spectrum**—Select this check box to display the full spectrum on your tune report.
- b. **Acquisition Threshold**—Enter a minimum peak height for the full scan spectrum on the tune report. If your peak has an intensity that is below this threshold, it will not be stored.
- c. **SIM Masses**—Select masses to be displayed on your tune report. You can select a maximum of five masses, one from each list. At least one mass must be displayed on the report.

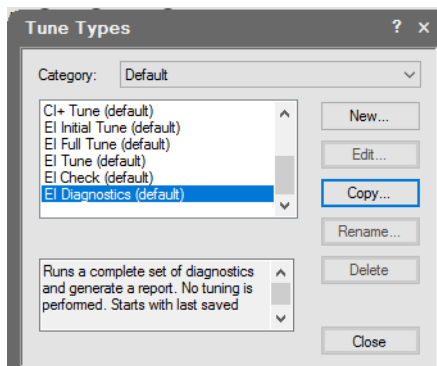
**Tip** Factory tunes cannot be altered. If a newly created tune does not perform as expected, you can always go back to a factory tune, copy it, and change the settings as described above. Save the new tune with a new name before closing the Edit Tune Type dialog box.

9. Once you are finished configuring all the tabs, click **Save** to save the tune type. Your new tune type appears in the Tune Types window.
10. Click **Close** to return to the dashboard. You can select the tune type in the automatic tune window.
11. If you want to rename a tune you created, open the Tune Types dialog box by clicking **Tune Types** on the TSQ Series Dashboard.

**Note** You cannot rename a factory tune.

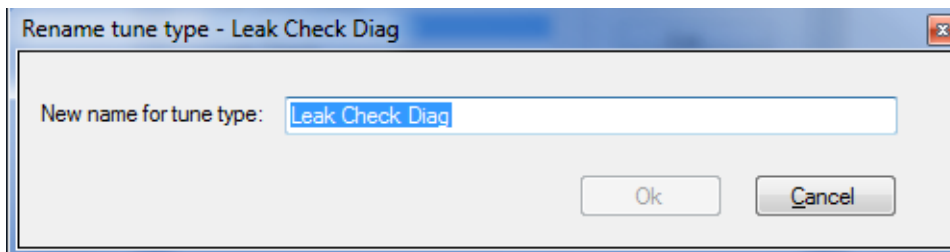
- a. Select **Rename** in the Tune Types dialog box. See [Figure 156](#).

**Figure 156.** Renaming a Tune Type



- b. The **Rename Tune Type** dialog box opens. Assign a valid new name to your tune. You will not be able enter a name that is an invalid file name or already in use. See [Figure 157](#).

**Figure 157.** Changing a Tune File Name



- c. Click **OK**.

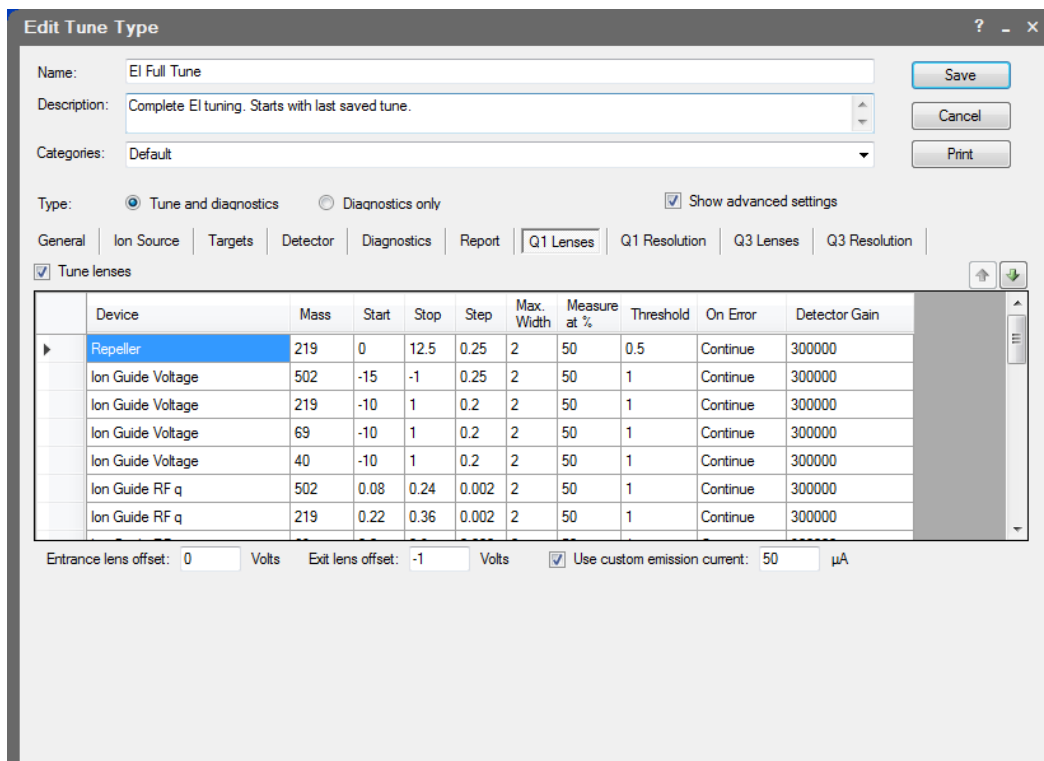
**Note** The following instructions refer to advanced tuning settings that most users will never need to access. Contact your local Thermo Fisher Scientific service organization before adjusting these settings.

❖ **To modify advanced tune settings in Xcalibur software**

1. To configure the **Q1 Lenses**, you must select the **Show Advanced Settings** check box. The lens tune is the main portion of the tune algorithm. In this section you can choose which components to tune, which mass to optimize for the tune, what the range of allowed values is, how to move through the range, how much the signal must change for a new value to be selected, and what (if anything) can be done about the resolution of the peak and any errors that occur. Select the **Tune Lenses** check box to access the data table. See [Figure 158](#).



Figure 158. Tuning the Q1 Lenses



- a. **Device**—Click in this box to select the component you want to tune according to the settings in the other columns.
  - i. **Repeller**—Controls how the repeller pushes the ions out of the ionization region. The voltage applied to this component has a very strong effect on the energy of the ion beam, which has a strong effect on the resolution and the intensity. The lower the voltage, the better the resolution. However, higher voltages will prevent ions from striking the repeller surface, which leads to better robustness. A clean system typically tunes from 3 to 8 V, although a dirty system may have the repeller climb as high as 12.5 V. Do not set the repeller any higher.

**Note** The repeller is not tuned if the AEI ion source is installed.

- ii. **Lens 1**—Controls Lens 1, which is the first of three lenses that the ions see as they leave the ionization region. These three lenses act as a focusing element to maximize the ion beam intensity that is entering the ion guide. This field is typically set between  $-35$  and  $-50$  V.

**Note** Lens 1 is not tuned if the AEI ion source is installed.

- iii. **Lens 2**—Controls Lens 2, which is the second of three lenses that the ions see as they leave the ionization region. These three lenses act as a focusing element to maximize the ion beam intensity that is entering the ion guide. This field is typically set between 0 and  $-15$  V.

- iv. **Lens 3**—Controls Lens 3, which is the last of three lenses that the ions see as they leave the ionization region. These three lenses act as a focusing element to maximize the ion beam intensity that is entering the ion guide. This field is typically set between -30 and -35 V.

**Note** The Lens 3 voltage is fixed and calculated from the electron energy when using the AEI source. Do not add a tune entry for Lens 3 when using the AEI source

- v. **Ion Guide Voltage**—Controls the ion guide's DC offset voltage. It can potentially help focus the ions into the quadrupole while ensuring that neutral noise is eliminated. The voltage on this component is mass dependent and should be set at several different masses. This field is typically set between +1 and -15 V, depending on the mass of the ion.
  - vi. **Ion Guide RF q**—Controls the ion guide's RF q (amplitude). This device is mass dependent and should be set at several different masses. This field can be tuned between 0 and 2. This device determines the ion guide RF amplitude tune value which is given as the  $RF\ q * (m/z)$ .
  - vii. **Ion Guide RF**—(This setting is maintained for compatibility with legacy tune types. For new tune types, Ion Guide RF q is the recommended setting.) Controls the ion guide's RF voltage. It can potentially help focus the ions into the quadrupole while ensuring that neutral noise is eliminated. The voltage on this component is mass dependent and should be set at several different masses. This field is typically set between 0 and +5 V, depending on the mass of the ion.
  - viii. **Q1 Voltage**—Controls the voltage that pulls the ions into the quadrupole. The voltage applied to this component has a very strong effect on the energy of the ion beam, which has a strong effect on the resolution and the intensity. The lower the voltage, the better the resolution. However, higher voltages will pull more ions into the quads, which leads to better signal. This field is typically set between 0 and -5 V.
  - ix. **Q1 Resolution**—Adjusts the ratio of the quadrupole DC and RF voltages to create the resolution required for your analysis. You can set the desired peak width at a given mass and whether you measure the width at 10% or 50% of the peak height. Because there is no static DC voltage involved, the start, stop, and step values are not used.
- b. **Mass**—Click in this box to select the ion to be used for tuning.
  - c. **Start**—Enter the starting voltage for the tune. The start voltage must always be less than the stop voltage. For example, -35 is smaller than 0.
  - d. **Stop**—Enter the final voltage for the tune.
  - e. **Step**—Enter the increment for the tuning range. For example, if you tune from 0-50 in increments of 10 V, then you would set the **Step** field to 10.

**Note** If the start and stop values are the same value, the device will be set to that value and ignore the step size. In some tunes, devices are set to a value before tuning them in another line. This presetting is done because ramping devices do not allow the tune to run at values higher than those chosen for higher masses for the same device.

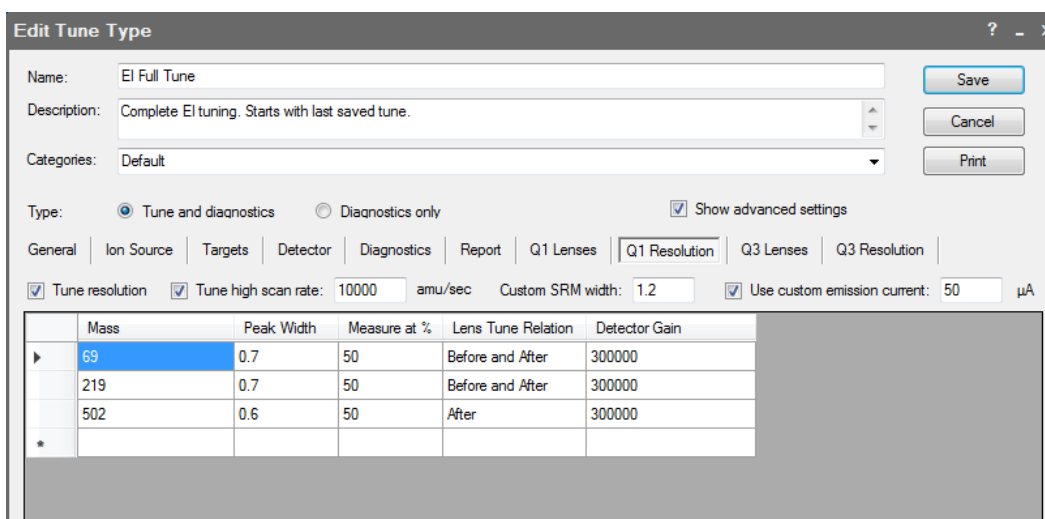
- f. **Max Width**—Enter the maximum allowable width of the ion during the tune.
- g. **Measure at %**—Click in this box to select the location on the peak where you want to measure the maximum width.
  - **10**—Measures the width at 10% of the peak height.
  - **50**—Measures the width at 50% of the peak height.
- h. **Threshold**—Enter the change in intensity that has to occur when the tune selects a new voltage. For example, if you set this field to 1.1, the tune will not select a new voltage for that component unless the intensity is 110% of the old intensity. If you set this field to 1, anytime the new voltage has an intensity larger than the old intensity, the tune will select the new intensity.

**Note** If you choose a value less than 1 for ramped devices, the tune steps back in energy until the lower intensity is detected. For example, if you choose 0.8, the device value lower in energy than the device value with the maximum response that gives an intensity closest to 80% of the maximum intensity is chosen.

- i. **On Error**—Click in this box to select how to handle an error in the tune.
  - **Fail**—Stops the tune when an error occurs or if no tune points are found meeting the tune criteria.
  - **Continue**—Allows the tune to continue on to the next device when an error occurs.
- j. **Detector Gain**—Enter a new value for the detector gain in this field. When changing detector gain, a mandatory delay is added. To optimize tune times, minimize changes in detector gain by placing devices and ions that require the same gain together. Lowering Detector Gain will also reduce detector wear when tuning with intense signal.
- k. **Entrance lens offset** and **Exit lens offset**—Changing these voltages affects ion acceleration. The default levels will give the best performance; changing the voltages will affect peak resolution.
- l. **Use Custom Emission Current**—Select this option to use a custom emission current when tuning the Q1 lenses. If this feature is not selected, the tune will use the emission current set in the **Ion Source** tab. Reducing the emission current when tuning the Q1 lenses can help keep the ion source clean and extend the life of the electron multiplier, especially if there is an AEI source installed on the system.

- Click the **Q1 Resolution** tab to configure the resolution of your tune. You must select the **Show Advanced Settings** check box to access this tab. Selecting this option tunes the resolution of Quadrupole 1 by itself. This resolution tunes the system at 100 and 1000 amu/s scan rates. You can tune the resolution during a lens tune or you can tune the resolution by itself. See [Figure 159](#).

**Figure 159.** Configuring Q1 Resolution

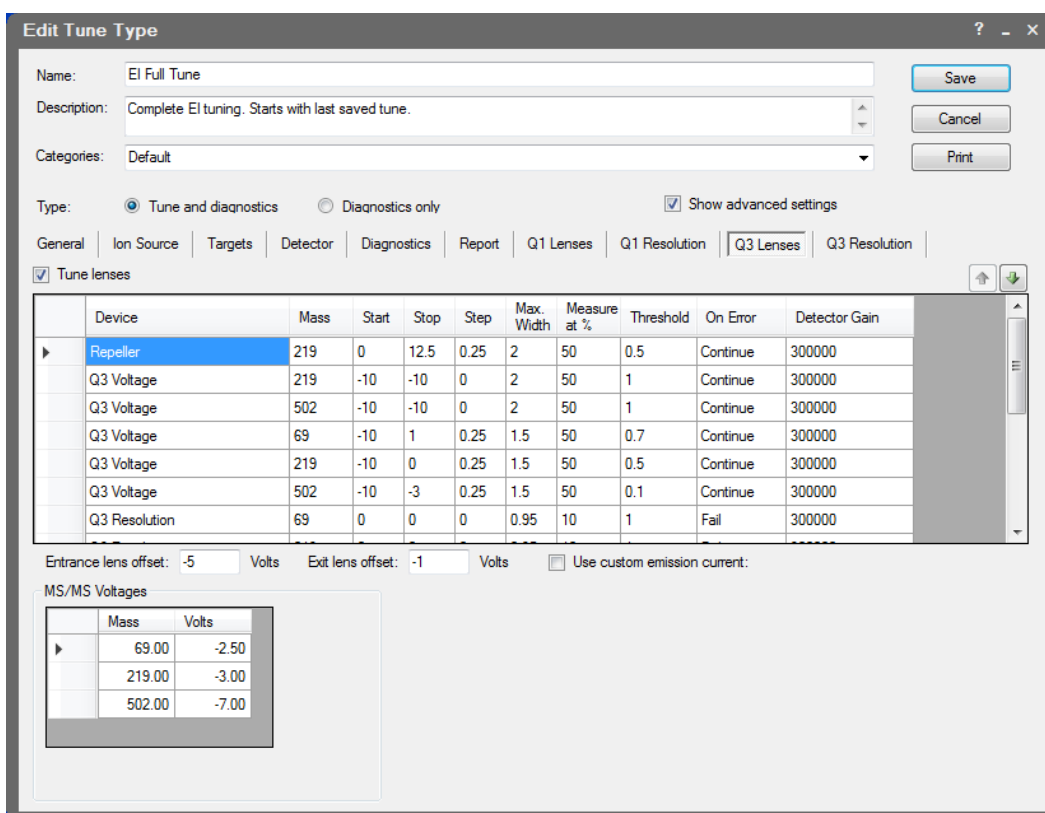


**Note** Changing the Q1 lenses or resolution affects the Q3 lenses and resolution.

- Mass**—Click in this box to select the ion to be used for tuning.
- Peak Width**—Enter the target peak width.
- Measure at %**—Click in this box to select the location on the peak where you want to measure the target peak width.
  - 10**—Measures the width at 10% of the peak height.
  - 50**—Measures the width at 50% of the peak height.
- Lens Tune Relation**—Click in this box to set the occurrence of the resolution tune parameters before or after a lens tune.
  - Before and After**—Uses the same resolution parameters before and after a lens tune.
  - Before**—Uses the resolution parameters before a lens tune.
  - After**—Uses the resolution parameters after a lens tune.
- Detector Gain**—Enter a new value for the detector gain in this field. When changing detector gain, a mandatory delay is added. To optimize tune times, minimize changes in detector gain by placing devices and ions that require the same gain together. Lowering Detector Gain is very useful for reducing detector wear during the portions of the resolution tune that under-resolve ions, making heavy ion current at the detector.

- f. **Custom SRM Width**—Use this field to change the peak width of the precursor mass for SRM scans. The default width is 1.2 FWHM. This width may be selected as “Custom” in SRM instrument methods.
  - g. **Use Custom Emission Current**—Select this option to use a custom emission current when tuning the Q1 resolution. If this feature is not selected, the tune will use the emission current set in the **Ion Source** tab. Reducing the emission current when tuning the Q1 resolution can help keep the ion source clean and extend the life of the electron multiplier, especially if there is an AEI source installed on the system.
3. Select the **Q3 Lenses** tab to configure the Q3 lenses. You must select the **Show Advanced Settings** check box to access this tab. The lens tune is the main portion of the tune algorithm. In this section you can choose which components to tune, which mass to optimize for the tune, what the range of allowed values are, how to move through the range, how much the signal must change for a new value to be selected, and what (if anything) must be done about the resolution of the peak and any errors that occur. See [Figure 160](#).

**Figure 160.** Tuning the Q3 Lenses

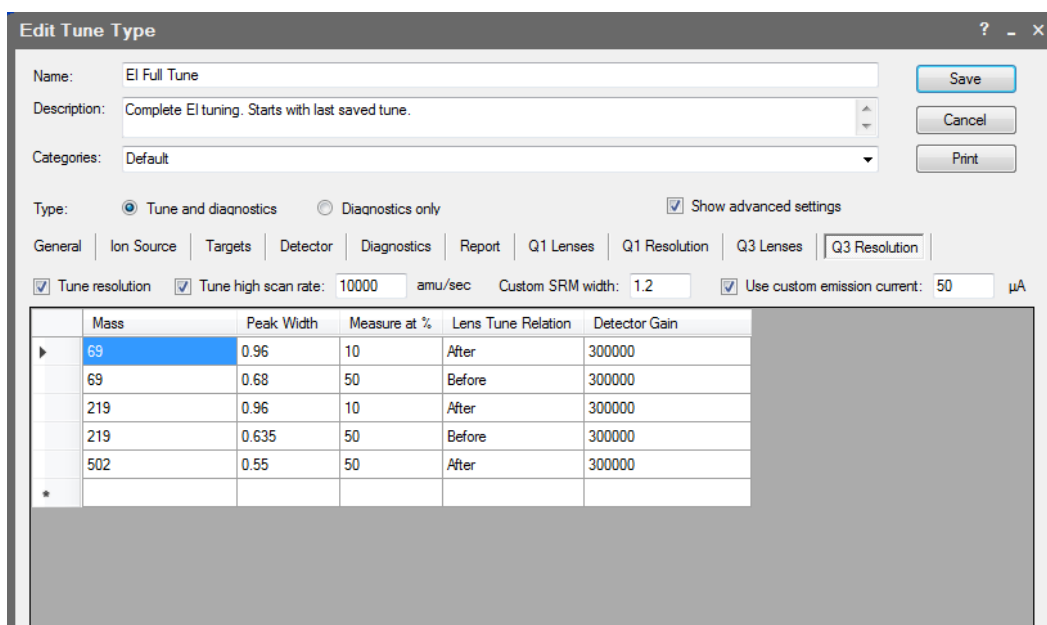


- a. **Q3 Voltage**—Controls the voltage that pulls the ions into the quadrupole. The voltage applied to this component will have a very strong effect on the energy of the ion beam, which will have a strong effect on the resolution and the intensity. The lower the voltage, the better the resolution. However, higher voltages will pull more ions into the quads, which leads to better signal. This field is typically set between 0 and -5 V.

- b. **Resolution**—Adjusts the ratio of the quadrupole DC and RF voltages to create the resolution required for your analysis. You can set the desired peak width at a given mass and whether you measure the width at 10% or 50% of the peak height. Because there is no static DC voltage involved, the start, stop, and step values are not used.
- c. **Mass**—Click in this box to select the ion to be used for tuning.
- d. **Start**—Enter the starting voltage for the tune. The start voltage must always be less than the stop voltage. For example,  $-35$  is smaller than  $0$ .
- e. **Stop**—Enter the final voltage for the tune.
- f. **Step**—Enter the increment for the tuning range. For example, if you tune from  $0$ - $50$  in increments of  $10$  V, then you would set the **Step** field to  $10$ .
- g. **Max Width**—Enter the maximum allowable width of the ion during the tune.
- h. **Measure at %**—Click in this box to select the location on the peak at which you want to measure the maximum width.
  - **10**—Measures the width at 10% of the peak height.
  - **50**—Measures the width at 50% of the peak height.
- i. **Threshold**—Enter the change in intensity that has to occur when the tune selects a new voltage. For example, if you set this field to  $1.1$ , the tune will not select a new voltage for that component, unless the intensity is  $110\%$  of the old intensity. If you set this field to  $1$ , anytime the new voltage has an intensity larger than the old intensity, the tune will select the new intensity.
- j. **On Error**—Click in this box to select how to handle an error in the tune.
  - **Stop**—Stops the tune when an error occurs.
  - **Continue**—Allows the tune to continue on to the next device when an error occurs.
- k. **Detector Gain**—Enter a new value for the detector gain in this field. When changing detector gain, a mandatory delay is added. To optimize tune times, minimize changes in detector gain by placing devices and ions that require the same gain together. Lowering detector gain will also reduce detector wear when tuning with intense signal.
- l. **Entrance lens offset** and **Exit lens offset**—Changing these voltages affects ion acceleration. The default levels will give the best performance; changing the voltages will affect peak resolution.
- m. **Use Custom Emission Current**—Select this option to use a custom emission current when tuning the Q3 lenses. If this feature is not selected, the tune will use the emission current set in the **Ion Source** tab. Reducing the emission current when tuning the Q3 lenses can help keep the ion source clean and extend the life of the electron multiplier, especially if there is an AEI source installed on the system.

- n. **MS/MS Voltages**—These overwrite the Q3 voltage tune values when the instrument is in SRM mode. These values are not tuned and are added to the collision energy used in the SRM scan.
4. Click the **Q3 Resolution** tab to configure the resolution of your tune. You must select the **Show Advanced Settings** check box to access this tab. Select this option to tune the resolution of Quadrupole 3 by itself. This resolution will tune the system at 100 and 1000 amu/s scan rates. You may also tune at a higher scan rate. You can tune the resolution during a lens tune or you can tune the resolution by itself. See [Figure 161](#).

**Figure 161.** Configuring the Q3 Resolution



- Mass**—Click in this box to select the ion to be used for tuning.
- Peak Width**—Enter the target peak width.
- Measure at %**—Click in this box to select the location on the peak at which you want to measure the target peak width.
  - 10**—Measures the width at 10% of the peak height.
  - 50**—Measures the width at 50% of the peak height.
- Lens Tune Relation**—Click in this box to set the occurrence of the resolution tune parameters before or after a lens tune.
  - Before and After**—Uses the same resolution parameters before and after a lens tune.
  - Before**—Uses the resolution parameters before a lens tune.
  - After**—Uses the resolution parameters after a lens tune.
- Detector Gain**—Enter a new value for the detector gain in this field. When changing detector gain, a mandatory delay is added. To optimize tune times, minimize changes

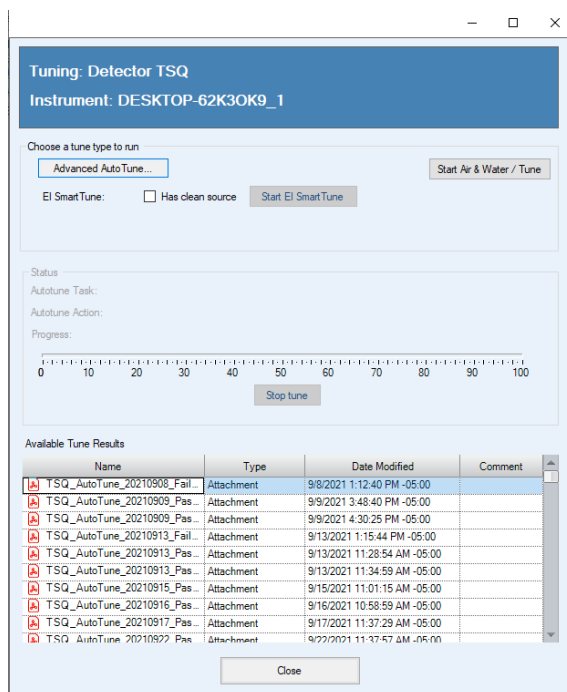
in detector gain by placing devices and ions that require the same gain together. Lowering Detector Gain is very useful for reducing detector wear during the portions of the resolution tune that under-resolve ions, making heavy ion current at the detector.

- f. **Custom SRM Width**—Use this field to change the peak width of the product mass for SRM scans. The default width is 1.2 FWHM. This width may be selected as “Custom” in SRM instrument methods.
- g. **Use Custom Emission Current**—Select this option to use a custom emission current when tuning the Q3 resolution. If this feature is not selected, the tune will use the emission current set in the Ion Source tab. Reducing the emission current when tuning the Q3 resolution can help keep the ion source clean and extend the life of the electron multiplier, especially if there is an AEI source installed on the system.
- h. **Tune High Scan Rate**—Select this check box to tune the resolution at a scan rate in addition to the 100 and 1000 amu/s default scan rates.

❖ **To modify an automatic tune in Chromeleon software**

1. From the TSQ epanel, select **Tuning | Advanced AutoTune**. The **Tuning: Detector ISQ** window opens. Click **Advanced AutoTune**. See [Figure 162](#).

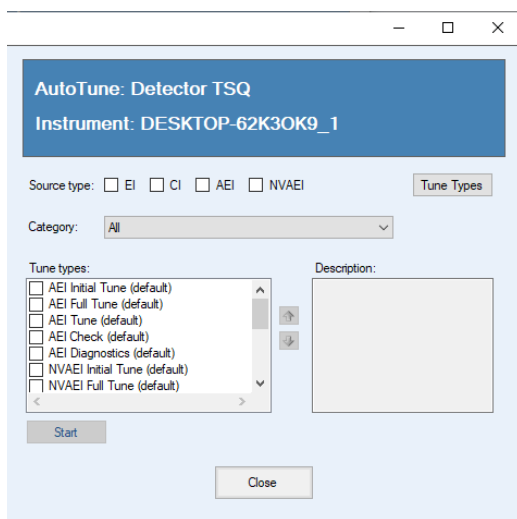
**Figure 162.** Accessing the Tune Type Editor in Chromeleon Software



2. The **AutoTune: Detector TSQ** window opens. Click **Tune Types**. See [Figure 163](#).

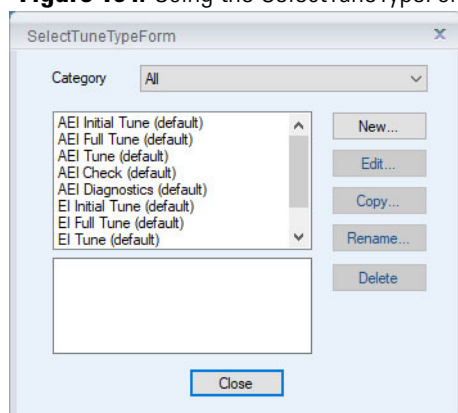


**Figure 163.** Accessing the Tune Type Editor from Chromeleon Software



3. In the **SelectTuneTypeForm** dialog box, select a tune type to edit and click the **Copy** button. See [Figure 164](#).

**Figure 164.** Using the SelectTuneTypeForm Dialog Box



4. Configure the parameters under the **General** tab. See [Figure 165](#).

Figure 165. Configuring General Tuning Parameters

- a. **Name**—Enter a name for your tune type.

**Note** Create the new tune type name now. You will not be able to edit the tune type name later. Also, you will not be able to save new parameters to a built-in tune.

- b. **Description**—Enter details or notes about your tune type.
- c. **Categories**—This is an optional field that allows you to display a subset of tunes under Auto Tune on the dashboard. This is convenient for separating your most frequently used tunes.
- d. **Type**—Select the **Tune and Diagnostics** option to run a tune with diagnostics or select the **Diagnostics Only** option if you are creating a diagnostics test.
- e. **Output Tune Filename Prefix**—Enter a prefix to be added to the title of your tune report. It is a good idea to use a descriptive prefix for your tune type. For example, if you are always running BFB reports, you could enter BFB here to distinguish it from other reports you are generating.
- f. **Starting Tune File**—Select a tune file that your tune type will be based on:

**Note** If you select a tune file with a prefix-only name rather than a tune file with a date-time stamp, the most recent tune file of with that prefix name will be loaded at the start of each tune.

- Select **Factory** to use a default factory-made file on the instrument that can be used to begin tuning an instrument with a clean ion source.
- Select **Last Saved** to use a tune file saved on the instrument by the most recent successful automatic tune.

- Select a specific tune file if you have a reliable tune file you want to use as a starting point for a new tune file.
- g. **Perform Mass Calibration**—Select this to enable the system to recalibrate all of the masses during a tune.
  - h. **Check Mass Calibration**—Select this to enable the system to confirm that your mass calibration is correct rather than performing a mass calibration.

**Note** If Tune and Diagnostics is selected, you can select only one Mass Calibration option.

5. Select the **Ion Source** tab to configure the ion source parameters. See [Figure 166](#).

**Figure 166.** Configuring the Ion Source Parameters

- a. **Ionization Mode & Ion Polarity**—Use this pull-down menu to select a mode:
  - Select **EI +** to run a tune in Electron Ionization (EI) mode.
  - Select **CI+** to run a tune in Chemical Ionization (CI) mode and positive ions.
  - Select **CI-** to run a tune in CI mode and negative ions.
- b. **Using AEI Source**—Select if you have an AEI Source installed and want to edit an EI tune.
- c. **CI Gas Type** (only enabled if you select CI+ or CI-)—Use this pull-down menu to select a gas type, but make sure your selection is the reagent gas attached to your system and that the correct gas port is selected. Methane is commonly used for CI+. Other gases will change the efficiency and energy of the ionization process.

**Note** When changing CI gas types or gas port, there is a two minute delay while the reagent gas is purging. During this time, the Busy light will be lit and you will need to wait until the light goes off before using the software.

- d. **Emission Current**—Defines the emission current that you use to run subsequent tunes, but not the emission current that is used for data acquisition. Lowering the emission current can extend the time between required cleaning of the ion source and replacement of the filament as well as extend the life of the detector.
- **Tune File**—Select this option to use the value in the tune file that you selected on the General tab.
  - **Default**—Select this option to use the default emission current, which is 50  $\mu\text{A}$  for EI systems and 10  $\mu\text{A}$  for AEI systems.
  - **Custom**—Select this option if you want to use an emission current other than the default value to increase or decrease the sensitivity of the instrument. Tune with the same value you are planning to use for your analysis. The use of emission currents above 100  $\mu\text{A}$  may lead to the generation of too many ions in the source and a degradation in resolution.
- e. **Electron Energy**—Indicates the energy of the electrons emitted by the filament.
- **Default**—Select this option to use the default electron energy, which is 70 eV for the EI ion source and 50 eV for the AEI ion source.
  - **Tune File**—Select this option to use the value in the tune file you selected in the General tab.
  - **Custom**—Select this option to set the energy of the electrons emitted by the filament. Changing the electron energy affects the ionization efficiency and fragmentation of the sample. This is typically set to 70 V with the EI ion source because the standard EI libraries are based on 70 eV electron beams.
- f. **Electron Lens Positive Voltage**—Allows the electrons to enter the ion volume.
- **Default**—Select this option to use the default electron lens positive voltage, which is 5 V.
  - **Tune File**—Select this option to use the value used in the tune file that you selected on the General tab.
  - **Custom**—Select this option if you do not want to use the default value for the tune. For the electron lens positive voltage, the default is 5 V. You should tune with the same value you are planning to use for your analysis. This value affects the focusing of the electron beam into the source. If you change your electron energy from 70 eV, this value also changes. This voltage must always be at least 45 V above the voltage applied to the filament in order for the instrument software to allow the filament to be turned on. The voltage applied to the filament is the same number, but the opposite sign, of the electron energy. The settable range is 0–150 V.

**Note** When using the AEI source, this lens acts as an ion repeller, so setting a higher value may make it more difficult to pass resolution tuning. Values above 7 to 10 V are not recommended for the AEI source.

g. **Electron Lens Negative Voltage.**

- **Default**—Select this option to use the default electron lens negative voltage, which is  $-75$  V.
- **Tune File**—Select this option to use the value used in the tune file that you selected on the General tab.
- **Custom**—Select this option if you do not want to use the default value for the tune. For the electron lens negative voltage, the default is  $-75$  V. Tune with the same value you are planning to use for your analysis. This value affects how well the electrons are kept from entering the ion source when they are not supposed to. If you change your electron energy from 70 eV, this value also changes. Ensure this voltage is at least 5 V below the voltage applied to the filament.

- h. **Set Ion Source Temperature**—Select this check box to enable the temperature field. Then enter a value between 0 and 350 °C. The default is 200 °C. The optimal temperature is determined by the molecular structure and weight of the compounds you are analyzing. Heavier compounds require a higher temperature. Tune at the same temperature you will use to run your samples. You should set the temperature as high as possible to keep the ion source clean and maintain the right amount of sensitivity. In general, it is advisable to set the ion source temperature higher than the transfer line temperature.

**Tip** If you tune regularly between running sample sets, you can save time waiting for the temperatures to equilibrate by setting the tune temperatures to the same temperature used in your acquisition method.

6. Click the **Targets** tab to configure how you want to tune your targets. Target tuning is used to adjust the way the mass spectrometer tunes to meet regulatory requirements. Otherwise, this is an optional setting. See [Figure 167](#).

Figure 167. Configuring Tuning Targets

Name: NewTune1  
Description:  
Categories:  
 Tune and diagnostics  Diagnostics only  
 Show advanced settings  
General | Ion source | **Targets** | Detector | Diagnostics | Report

Tune target ion ratios

Target mass	Ratio	
50 amu:	1.1	% (25 to 51.5 amu)
69 amu:	100.0	% (51.5 to 78.5 amu)
131 amu:	90.0	% (78.5 to 132.5 amu)
219 amu:	70.0	% (132.5 to 220.5 amu)
414 amu:	2.0	% (220.5 to 415.5 amu)
502 amu:	1.3	% (415.5 amu and above)

**Tune Target Ion Ratios**—Select this check box to adjust the ratios based on the results from an injection of tuning compound.

7. Click the **Detector** tab to configure the detector. See [Figure 168](#).

Figure 168. Configuring the Detectors

Name: NewTune1  
Description:  
Categories:  
 Tune and diagnostics  Diagnostics only  
 Show advanced settings  
General | Ion source | Targets | **Detector** | Diagnostics | Report

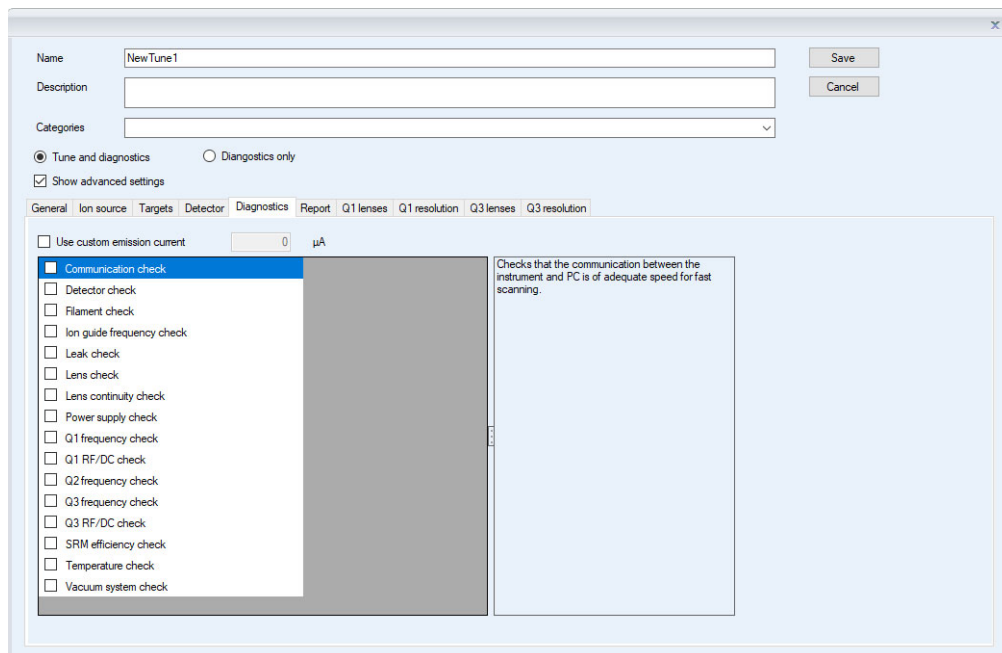
Set initial detector gain 3.00E+005

Tune detector  
 Use custom emission current 50  $\mu$ A

Adjust detector sensitivity  
Mass: 69 Intensity: 20,000,000

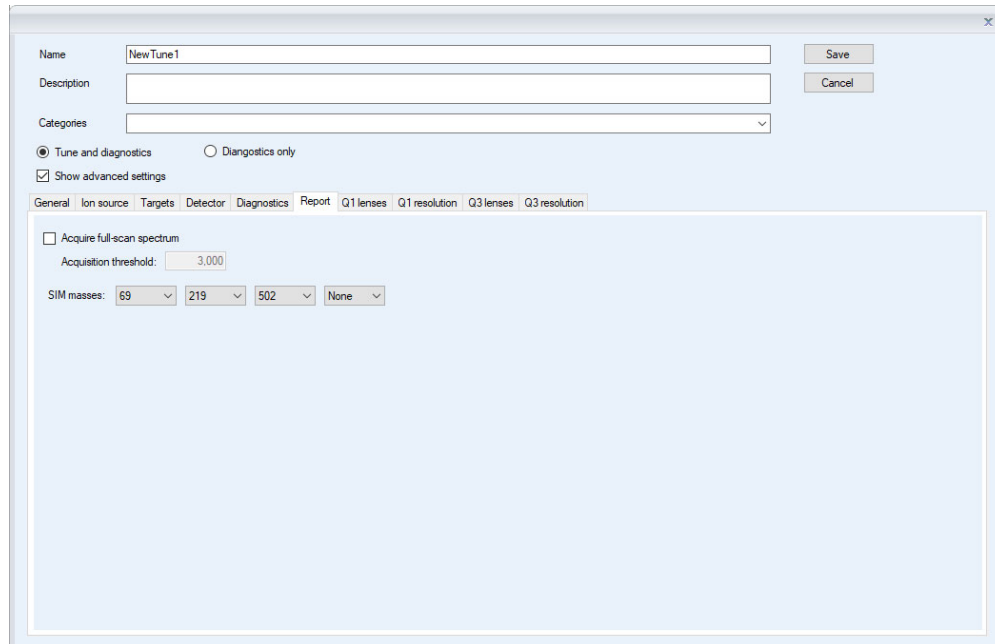
- a. **Set Initial Detector Gain**—Select this option to set the electron multiplier gain that will be used in tuning the instrument. The gain is the number of electrons generated for every ion that strikes the detector. This is typically set at  $3 \times 10^5$  electrons per ion. Gains larger than this will generate more electrons per ion, but both the analyte ion and the noise ion signals will be larger. You can also tune to lower gain values, which decreases the signal strength. Lower values also increase the chance that an ion will not be detected. Detector gains other than  $3 \times 10^5$  electrons per ion are not recommended for use in tuning.
  - b. **Tune Detector**—Select this check box to tune the detector. As the electron multiplier ages, the voltage required for a given gain increases. Depending on your sample load and if your system is leak tight (oxygen is bad for the detector), you should not have to perform this tune very often. Limit to 1–2 times a year.
  - c. **Use Custom Emission Current**—Select this option to use a custom emission current when tuning the detector. If this feature is not selected, the tune will use the emission current set in the **Ion Source** tab. Reducing the emission current when tuning the detector can help keep the ion source clean and extend the life of the electron multiplier, especially if there is an AEI source installed on the system.
  - d. **Adjust Detector Sensitivity**—Select this check box to tune the detector to generate a consistent area count of a calibration gas ion for the tune report. Because the intensity of the cal gas varies depending on the atmospheric pressure and temperature of the lab, this option results in larger variation in the analytical runs, as compared to using a fixed detector gain. If you use this function, set the initial detector gain to  $3 \times 10^5$  electrons per ion.
    - **Mass**—Select the calibration gas mass you want to use.
    - **Intensity**—Enter the intensity you want to see on the tune report.
8. Click the **Diagnostics** tab and select a test to confirm the operational ability of the system. See [Figure 169](#).

Figure 169. Setting Diagnostics



9. Click the **Report** tab configure how you want to view your data. See [Figure 170](#).

Figure 170. Selecting Data Report Options



- a. **Acquire Full-Scan Spectrum**—Select this check box to display the full spectrum on your tune report.
- b. **Acquisition Threshold**—Enter a minimum peak height for the full scan spectrum on the tune report. If your peak has an intensity that is below this threshold, it will not be stored.



- c. **SIM Masses**—Select masses to be displayed on your tune report. You can select a maximum of five masses, one from each list. At least one mass must be displayed on the report.

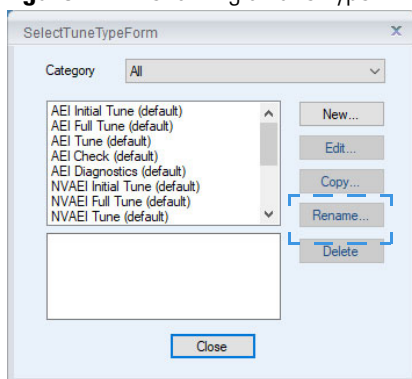
**Tip** Factory tunes cannot be altered. If a newly created tune does not perform as expected, you can always go back to a factory tune, copy it, and change the settings as described above. Save the new tune with a new name before closing the Edit Tune Type dialog box.

10. Once you are finished configuring all the tabs, click **Save** to save the tune type. Your new tune type appears in the Tune Types window.
11. Click **Close** to return to the dashboard. You can select the tune type in the automatic tune window.
12. If you want to rename a tune you created, open the Tune Types dialog box by clicking **Tune Types** on the TSQ Series Dashboard.

**Note** You cannot rename a factory tune.

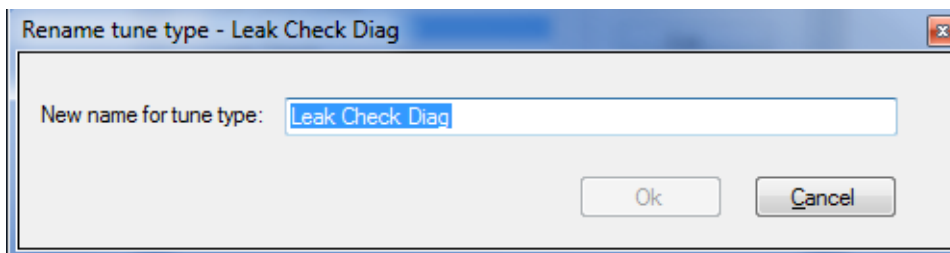
- a. Select **Rename** in the Tune Types dialog box. See [Figure 171](#).

**Figure 171.** Renaming a Tune Type



- b. The **Rename Tune Type** dialog box opens. Assign a valid new name to your tune. You will not be able enter a name that is an invalid file name or already in use. See [Figure 172](#).

**Figure 172.** Changing a Tune File Name



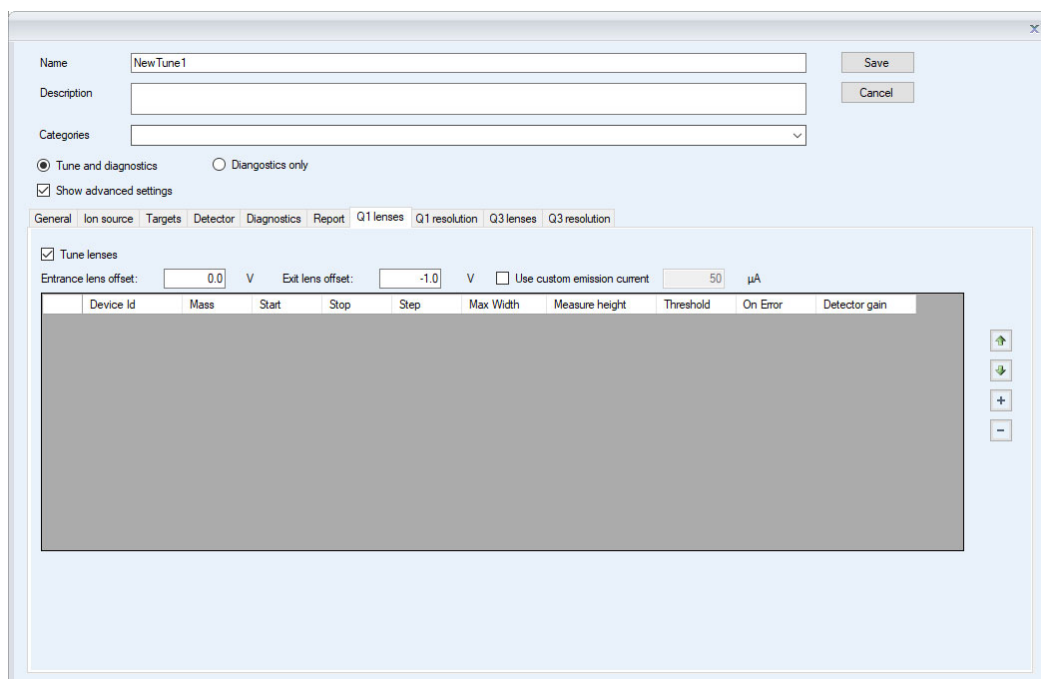
- c. Click **OK**.

**Note** The following instructions refer to advanced tuning settings that most users will never need to access. Contact your local Thermo Fisher Scientific service organization before adjusting these settings.

❖ **To modify advanced tune settings in Chromeleon software**

1. To configure the **Q1 Lenses**, you must select the **Show Advanced Settings** check box. The lens tune is the main portion of the tune algorithm. In this section you can choose which components to tune, which mass to optimize for the tune, what the range of allowed values is, how to move through the range, how much the signal must change for a new value to be selected, and what (if anything) can be done about the resolution of the peak and any errors that occur. Select the **Tune Lenses** check box to access the data table. See [Figure 173](#).

**Figure 173.** Tuning the Q1 Lenses



- a. **Device**—Click in this box to select the component you want to tune according to the settings in the other columns.
  - i. **Repeller**—Controls how the repeller pushes the ions out of the ionization region. The voltage applied to this component has a very strong effect on the energy of the ion beam, which has a strong effect on the resolution and the intensity. The lower the voltage, the better the resolution. However, higher voltages will prevent ions from striking the repeller surface, which leads to better robustness. A clean system typically tunes from 3 to 8 V, although a dirty system may have the repeller climb as high as 12.5 V. Do not set the repeller any higher.

**Note** The repeller is not tuned if the AEI ion source is installed.

- ii. **Lens 1**—Controls Lens 1, which is the first of three lenses that the ions see as they leave the ionization region. These three lenses act as a focusing element to maximize the ion beam intensity that is entering the ion guide. This field is typically set between  $-35$  and  $-50$  V.

**Note** Lens 1 is not tuned if the AEI ion source is installed.

- iii. **Lens 2**—Controls Lens 2, which is the second of three lenses that the ions see as they leave the ionization region. These three lenses act as a focusing element to maximize the ion beam intensity that is entering the ion guide. This field is typically set between  $0$  and  $-15$  V.
- iv. **Lens 3**—Controls Lens 3, which is the last of three lenses that the ions see as they leave the ionization region. These three lenses act as a focusing element to maximize the ion beam intensity that is entering the ion guide. This field is typically set between  $-30$  and  $-35$  V.

**Note** The Lens 3 voltage is fixed and calculated from the electron energy when using the AEI source. Do not add a tune entry for Lens 3 when using the AEI source

- v. **Ion Guide Voltage**—Controls the ion guide's DC offset voltage. It can potentially help focus the ions into the quadrupole while ensuring that neutral noise is eliminated. The voltage on this component is mass dependent and should be set at several different masses. This field is typically set between  $+1$  and  $-15$  V, depending on the mass of the ion.
- vi. **Ion Guide RF q**—Controls the ion guide's RF q (amplitude). This device is mass dependent and should be set at several different masses. This field can be tuned between  $0$  and  $2$ . This device determines the ion guide RF amplitude tune value which is given as the RF q \* ( $m/z$ ).
- vii. **Ion Guide RF**—(This setting is maintained for compatibility with legacy tune types. For new tune types, Ion Guide RF q is the recommended setting.) Controls the ion guide's RF voltage. It can potentially help focus the ions into the quadrupole while ensuring that neutral noise is eliminated. The voltage on this component is mass dependent and should be set at several different masses. This field is typically set between  $0$  and  $+5$  V, depending on the mass of the ion.
- viii. **Q1 Voltage**—Controls the voltage that pulls the ions into the quadrupole. The voltage applied to this component has a very strong effect on the energy of the ion beam, which has a strong effect on the resolution and the intensity. The lower the voltage, the better the resolution. However, higher voltages will pull more ions into the quads, which leads to better signal. This field is typically set between  $0$  and  $-5$  V.
- ix. **Q1 Resolution**—Adjusts the ratio of the quadrupole DC and RF voltages to create the resolution required for your analysis. You can set the desired peak width at a given mass and whether you measure the width at 10% or 50% of the

peak height. Because there is no static DC voltage involved, the start, stop, and step values are not used.

- b. **Mass**—Click in this box to select the ion to be used for tuning.
- c. **Start**—Enter the starting voltage for the tune. The start voltage must always be less than the stop voltage. For example,  $-35$  is smaller than  $0$ .
- d. **Stop**—Enter the final voltage for the tune.
- e. **Step**—Enter the increment for the tuning range. For example, if you tune from  $0-50$  in increments of  $10$  V, then you would set the **Step** field to  $10$ .

**Note** If the start and stop values are the same value, the device will be set to that value and ignore the step size. In some tunes, devices are set to a value before tuning them in another line. This presetting is done because ramping devices do not allow the tune to run at values higher than those chosen for higher masses for the same device.

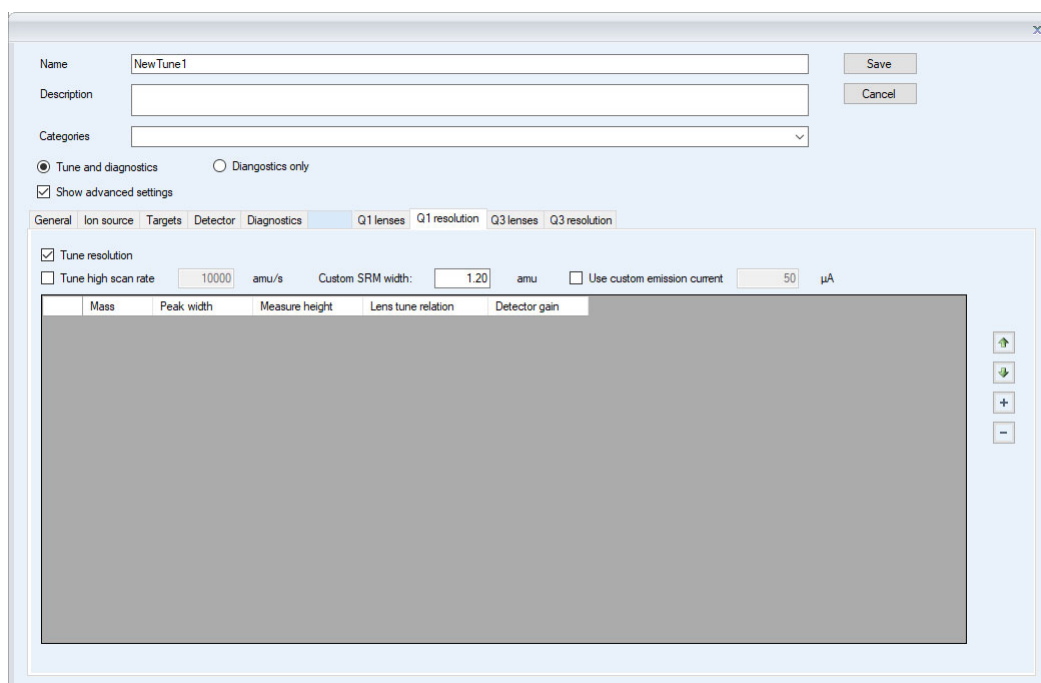
- f. **Max Width**—Enter the maximum allowable width of the ion during the tune.
- g. **Measure at %**—Click in this box to select the location on the peak where you want to measure the maximum width.
  - **10**—Measures the width at 10% of the peak height.
  - **50**—Measures the width at 50% of the peak height.
- h. **Threshold**—Enter the change in intensity that has to occur when the tune selects a new voltage. For example, if you set this field to  $1.1$ , the tune will not select a new voltage for that component unless the intensity is 110% of the old intensity. If you set this field to  $1$ , anytime the new voltage has an intensity larger than the old intensity, the tune will select the new intensity.

**Note** If you choose a value less than  $1$  for ramped devices, the tune steps back in energy until the lower intensity is detected. For example, if you choose  $0.8$ , the device value lower in energy than the device value with the maximum response that gives an intensity closest to 80% of the maximum intensity is chosen.

- i. **On Error**—Click in this box to select how to handle an error in the tune.
  - **Fail**—Stops the tune when an error occurs or if no tune points are found meeting the tune criteria.
  - **Continue**—Allows the tune to continue on to the next device when an error occurs.
- j. **Detector Gain**—Enter a new value for the detector gain in this field. When changing detector gain, a mandatory delay is added. To optimize tune times, minimize changes in detector gain by placing devices and ions that require the same gain together. Lowering Detector Gain will also reduce detector wear when tuning with intense signal.

- k. **Entrance lens offset** and **Exit lens offset**—Changing these voltages affects ion acceleration. The default levels will give the best performance; changing the voltages will affect peak resolution.
  - l. **Use Custom Emission Current**—Select this option to use a custom emission current when tuning the Q1 lenses. If this feature is not selected, the tune will use the emission current set in the **Ion Source** tab. Reducing the emission current when tuning the Q1 lenses can help keep the ion source clean and extend the life of the electron multiplier, especially if there is an AEI source installed on the system.
2. Click the **Q1 Resolution** tab to configure the resolution of your tune. You must select the **Show Advanced Settings** check box to access this tab. Selecting this option tunes the resolution of Quadrupole 1 by itself. This resolution tunes the system at 100 and 1000 amu/s scan rates. You can tune the resolution during a lens tune or you can tune the resolution by itself. See [Figure 174](#).

**Figure 174.** Configuring Q1 Resolution

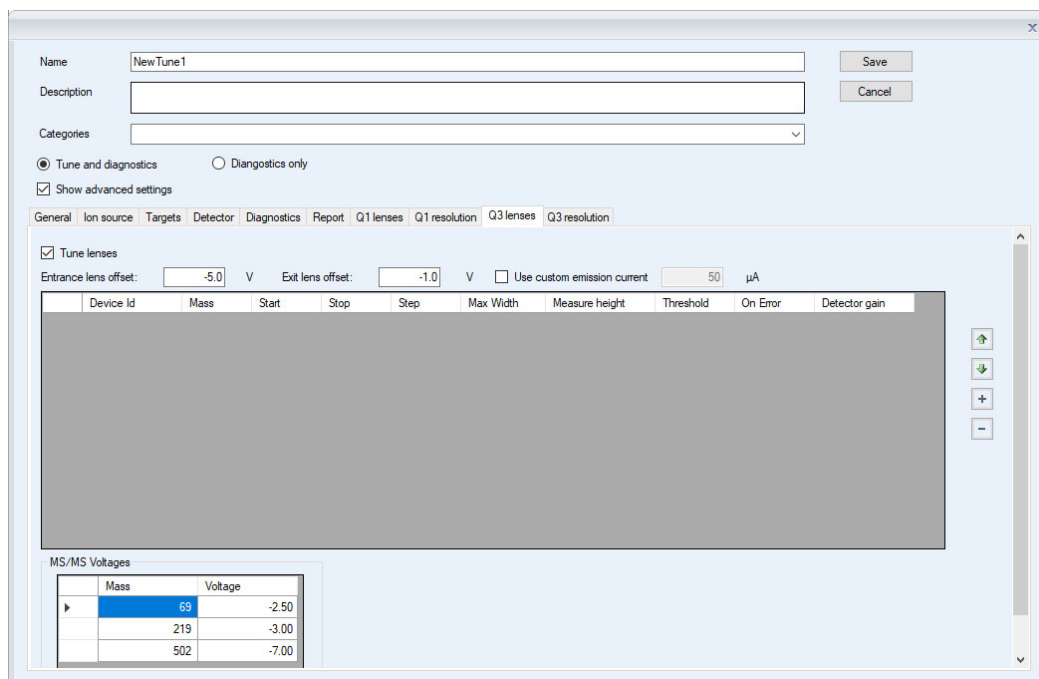


**Note** Changing the Q1 lenses or resolution affects the Q3 lenses and resolution.

- a. **Mass**—Click in this box to select the ion to be used for tuning.
- b. **Peak Width**—Enter the target peak width.
- c. **Measure at %**—Click in this box to select the location on the peak where you want to measure the target peak width.
  - **10**—Measures the width at 10% of the peak height.
  - **50**—Measures the width at 50% of the peak height.

- d. **Lens Tune Relation**—Click in this box to set the occurrence of the resolution tune parameters before or after a lens tune.
    - **Before and After**—Uses the same resolution parameters before and after a lens tune.
    - **Before**—Uses the resolution parameters before a lens tune.
    - **After**—Uses the resolution parameters after a lens tune.
  - e. **Detector Gain**—Enter a new value for the detector gain in this field. When changing detector gain, a mandatory delay is added. To optimize tune times, minimize changes in detector gain by placing devices and ions that require the same gain together. Lowering Detector Gain is very useful for reducing detector wear during the portions of the resolution tune that under-resolve ions, making heavy ion current at the detector.
  - f. **Custom SRM Width**—Use this field to change the peak width of the precursor mass for SRM scans. The default is width is 1.2 FWHM. This width may be selected as “Custom” in SRM instrument methods.
  - g. **Use Custom Emission Current**—Select this option to use a custom emission current when tuning the Q1 resolution. If this feature is not selected, the tune will use the emission current set in the **Ion Source** tab. Reducing the emission current when tuning the Q1 resolution can help keep the ion source clean and extend the life of the electron multiplier, especially if there is an AEI source installed on the system.
3. Select the **Q3 Lenses** tab to configure the Q3 lenses. You must select the **Show Advanced Settings** check box to access this tab. The lens tune is the main portion of the tune algorithm. In this section you can choose which components to tune, which mass to optimize for the tune, what the range of allowed values are, how to move through the range, how much the signal must change for a new value to be selected, and what (if anything) must be done about the resolution of the peak and any errors that occur. See [Figure 175](#).

Figure 175. Tuning the Q3 Lenses

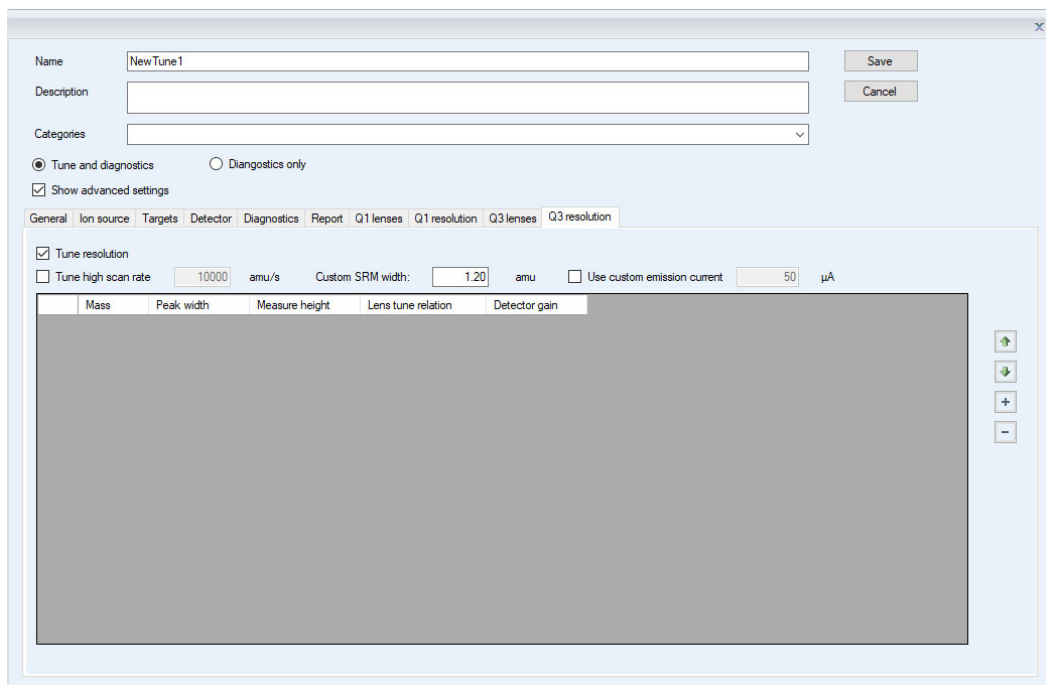


- a. **Q3 Voltage**—Controls the voltage that pulls the ions into the quadrupole. The voltage applied to this component will have a very strong effect on the energy of the ion beam, which will have a strong effect on the resolution and the intensity. The lower the voltage, the better the resolution. However, higher voltages will pull more ions into the quads, which leads to better signal. This field is typically set between 0 and  $-5$  V.
- b. **Resolution**—Adjusts the ratio of the quadrupole DC and RF voltages to create the resolution required for your analysis. You can set the desired peak width at a given mass and whether you measure the width at 10% or 50% of the peak height. Because there is no static DC voltage involved, the start, stop, and step values are not used.
- c. **Mass**—Click in this box to select the ion to be used for tuning.
- d. **Start**—Enter the starting voltage for the tune. The start voltage must always be less than the stop voltage. For example,  $-35$  is smaller than 0.
- e. **Stop**—Enter the final voltage for the tune.
- f. **Step**—Enter the increment for the tuning range. For example, if you tune from 0-50 in increments of 10 V, then you would set the **Step** field to 10.
- g. **Max Width**—Enter the maximum allowable width of the ion during the tune.
- h. **Measure at %**—Click in this box to select the location on the peak at which you want to measure the maximum width.
  - **10**—Measures the width at 10% of the peak height.
  - **50**—Measures the width at 50% of the peak height.

- i. **Threshold**—Enter the change in intensity that has to occur when the tune selects a new voltage. For example, if you set this field to 1.1, the tune will not select a new voltage for that component, unless the intensity is 110% of the old intensity. If you set this field to 1, anytime the new voltage has an intensity larger than the old intensity, the tune will select the new intensity.
  - j. **On Error**—Click in this box to select how to handle an error in the tune.
    - **Fail**—Stops the tune when an error occurs.
    - **Continue**—Allows the tune to continue on to the next device when an error occurs.
  - k. **Detector Gain**—Enter a new value for the detector gain in this field. When changing detector gain, a mandatory delay is added. To optimize tune times, minimize changes in detector gain by placing devices and ions that require the same gain together. Lowering detector gain will also reduce detector wear when tuning with intense signal.
  - l. **Entrance lens offset** and **Exit lens offset**—Changing these voltages affects ion acceleration. The default levels will give the best performance; changing the voltages will affect peak resolution.
  - m. **Use Custom Emission Current**—Select this option to use a custom emission current when tuning the Q3 lenses. If this feature is not selected, the tune will use the emission current set in the **Ion Source** tab. Reducing the emission current when tuning the Q3 lenses can help keep the ion source clean and extend the life of the electron multiplier, especially if there is an AEI source installed on the system.
  - n. **MS/MS Voltages**—These overwrite the Q3 voltage tune values when the instrument is in SRM mode. These values are not tuned and are added to the collision energy used in the SRM scan.
4. Click the **Q3 Resolution** tab to configure the resolution of your tune. You must select the **Show Advanced Settings** check box to access this tab. Select this option to tune the resolution of Quadrupole 3 by itself. This resolution will tune the system at 100 and 1000 amu/s scan rates. You may also tune at a higher scan rate. You can tune the resolution during a lens tune or you can tune the resolution by itself. See [Figure 176](#).



Figure 176. Configuring the Q3 Resolution



- a. **Mass**—Click in this box to select the ion to be used for tuning.
- b. **Peak Width**—Enter the target peak width.
- c. **Measure at %**—Click in this box to select the location on the peak at which you want to measure the target peak width.
  - **10**—Measures the width at 10% of the peak height.
  - **50**—Measures the width at 50% of the peak height.
- d. **Lens Tune Relation**—Click in this box to set the occurrence of the resolution tune parameters before or after a lens tune.
  - **Before and After**—Uses the same resolution parameters before and after a lens tune.
  - **Before**—Uses the resolution parameters before a lens tune.
  - **After**—Uses the resolution parameters after a lens tune.
- e. **Detector Gain**—Enter a new value for the detector gain in this field. When changing detector gain, a mandatory delay is added. To optimize tune times, minimize changes in detector gain by placing devices and ions that require the same gain together. Lowering Detector Gain is very useful for reducing detector wear during the portions of the resolution tune that under-resolve ions, making heavy ion current at the detector.

- f. **Custom SRM Width**—Use this field to change the peak width of the product mass for SRM scans. The default is width is 1.2 FWHM. This width may be selected as “Custom” in SRM instrument methods.
- g. **Use Custom Emission Current**—Select this option to use a custom emission current when tuning the Q3 resolution. If this feature is not selected, the tune will use the emission current set in the Ion Source tab. Reducing the emission current when tuning the Q3 resolution can help keep the ion source clean and extend the life of the electron multiplier, especially if there is an AEI source installed on the system.
- h. **Tune High Scan Rate**—Select this check box to tune the resolution at a scan rate in addition to the 100 and 1000 amu/s default scan rates.

## Using AutoSRM

This chapter tells you how to set up and run an AutoSRM discovery study. AutoSRM discovery studies have three sections:

- The precursor ion study
- The product ion study
- SRM optimization

As well as instructions for setting up and running each study, this user guide gives you the steps for importing the resulting transition list into the TSQ 9610 method editor and accessing them for routine use.

**Note** Set up your GC and autosampler methods through the TSQ 9610 method editor or TraceFinder before developing your AutoSRM method.

### Contents

- [Determining Precursor Ions](#)
- [Conducting the Product Ion Study](#)
- [Developing the SRM Optimization Study](#)
- [Importing Transitions to the Method Editor](#)

## Determining Precursor Ions

The purpose of the first study is to select your precursor ions. During this study, after you name your compounds and enter your vial numbers and retention times, AutoSRM instructs your system to run a full-scan analysis on the compounds.

For precursor ion studies, along with the resulting chromatographic peaks and full-scan spectra, AutoSRM presents you with a table of the most intense product ion masses that you may select. If you wish, however, AutoSRM can automatically pick the product ion masses.

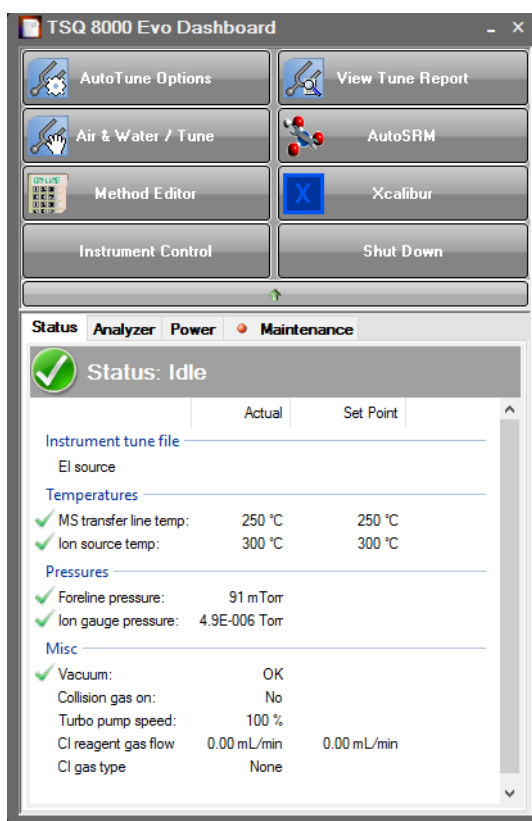
The user interface presents the full-scan peaks and attempts to identify your compounds based on the largest peak at the approximate retention time you provided. You may extract a single ion or perform a baseline subtraction to help you identify potential precursor ions.

**Note** You will need mid-range concentration standards (500 pg/uL–10 ng/uL) before setting up your AutoSRM method.

❖ **To determine your precursor ions in AutoSRM**

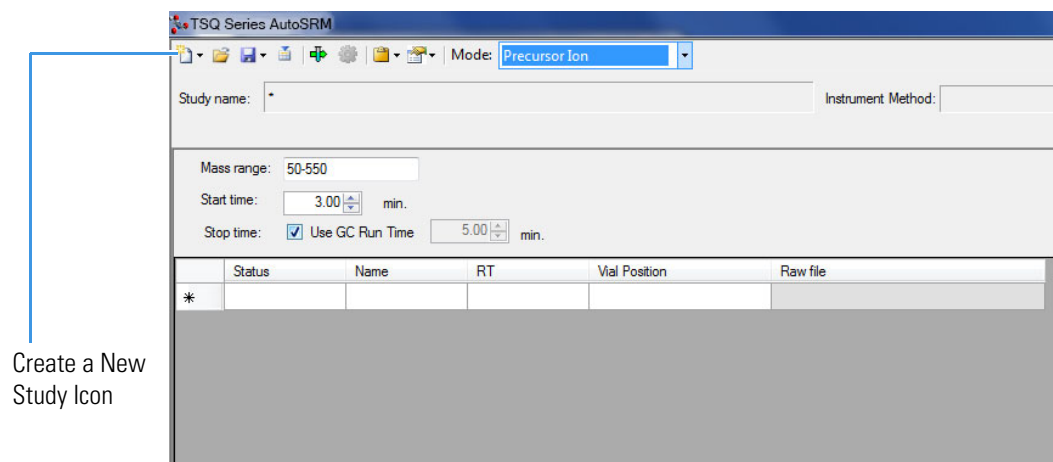
1. Open the TSQ 9610 Dashboard.
2. Click AutoSRM.

**Figure 177.** Accessing AutoSRM by the TSQ 9610 Dashboard



3. Click the **Create a New Study** icon on the left to create a new study.

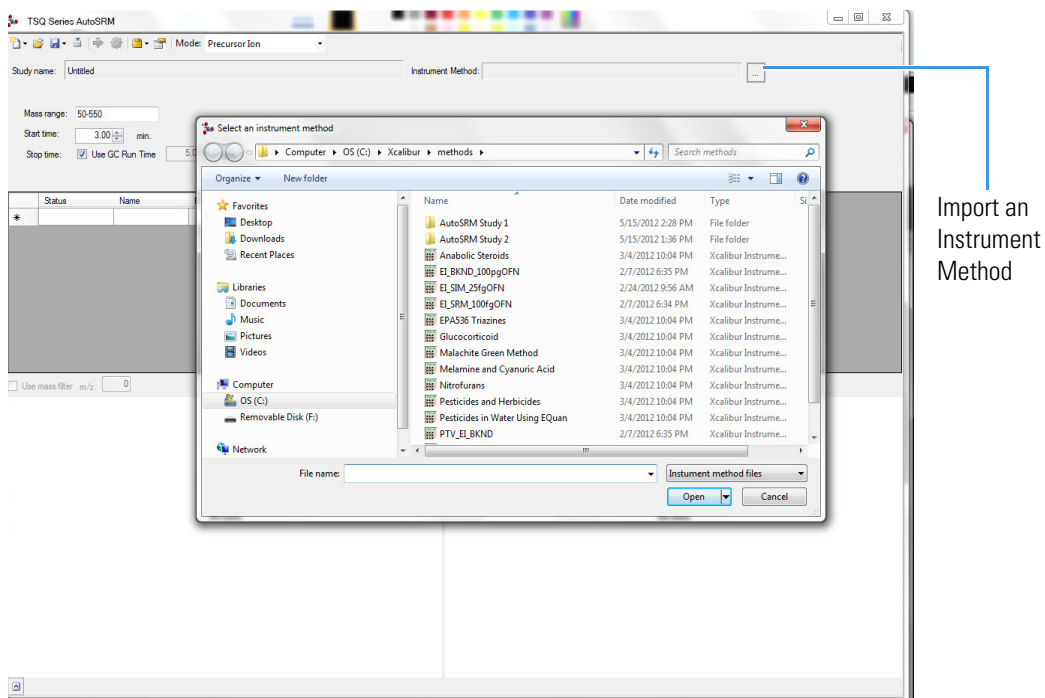
**Figure 178.** New AutoSRM Study



Create a New Study Icon

4. A new study window opens.
5. Link to your saved instrument method file (that you created using the MS method editor) by clicking on the ellipsis icon next to the Instrument Method window. AutoSRM will use the GC and autosampler parameters from this method file. See [Figure 179](#).

**Figure 179.** Retrieving an Instrument Method

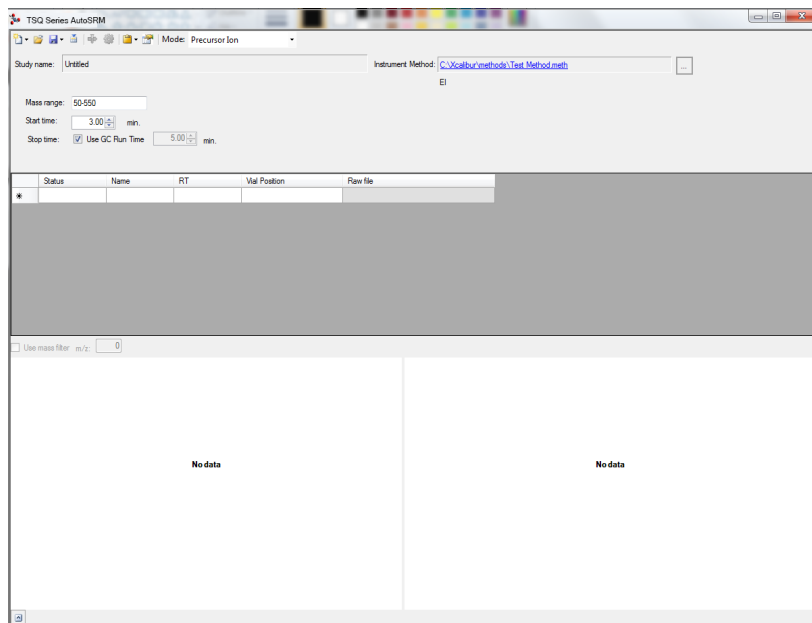


Import an Instrument Method

6. Select an instrument method file and click Open.
7. You may set the Mass Range, Start Time, and Stop Time. See [Figure 180](#).  
Any changes you make to your MS method here will override the method editor settings.

**Note** If the method's start time is reduced, you risk scanning over the solvent front. This might contaminate the source.

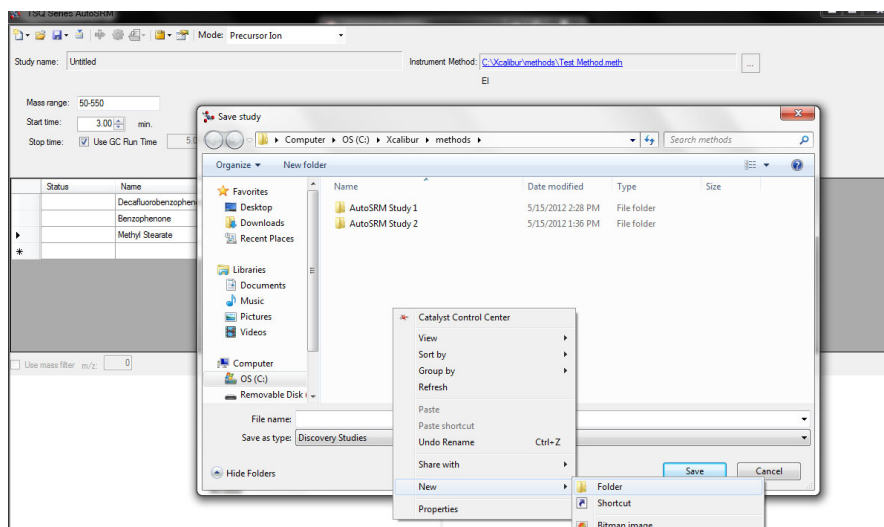
**Figure 180.** Adjusting the Settings



8. Enter the compound name, approximate retention time, and vial number for each compound you wish to optimize.
9. Save the study.

**Tip** Create a folder for all files associated with your AutoSRM study. Otherwise, the study results files will be saved in the general instrument method folder and crowd it. See [Figure 181](#).

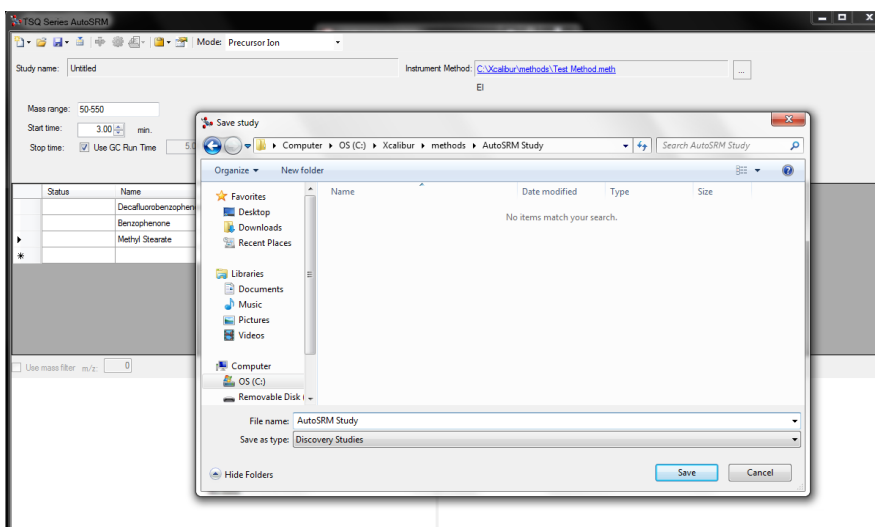
**Figure 181.** Creating an AutoSRM Study Folder



10. Open the folder.
11. Give your study a file name.
12. Save your study in the Study folder. See [Figure 182](#).

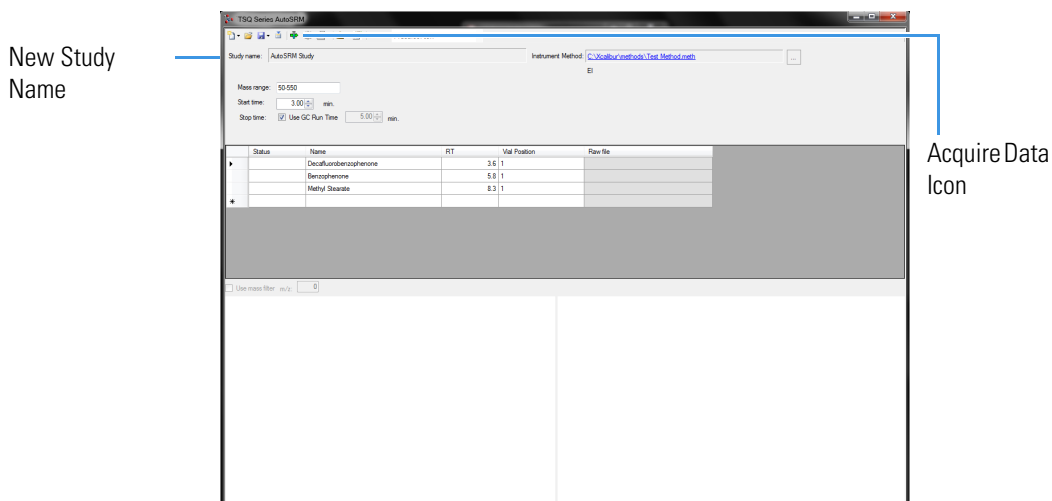
**Note** All files, including raw data files, that AutoSRM generates will be saved into the same folder that you save the study file. To simplify your workflow, create a folder for your study.

**Figure 182.** Saving an AutoSRM Study



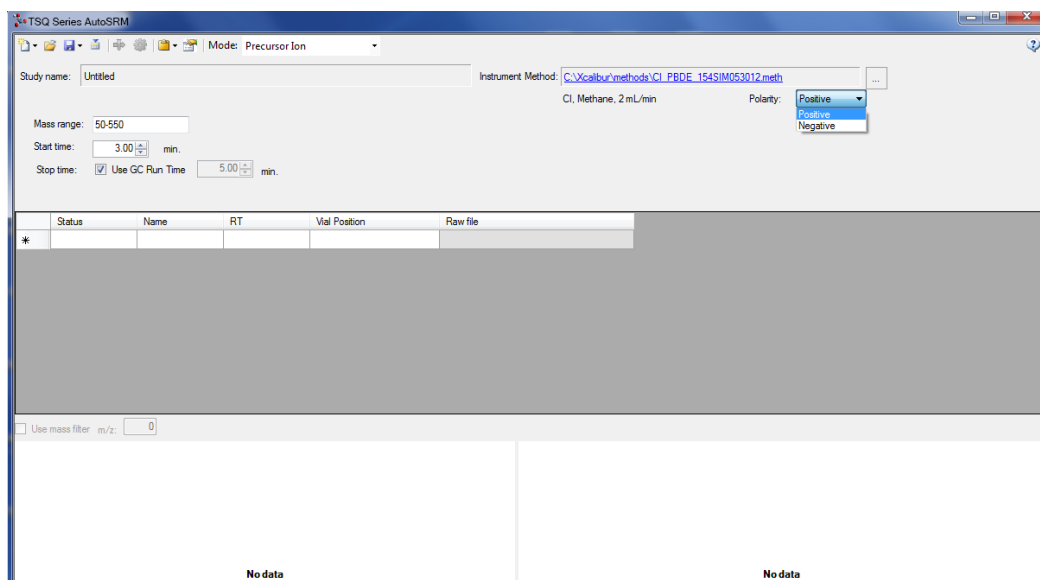
13. The Windows Explorer window closes.
14. The AutoSRM Study Name is the name you assigned. See [Figure 183](#).

**Figure 183.** Acquiring Acquisition Data



15. (CI Only) If you are running a chemical ionization (CI) study, select **Positive** or **Negative** from the **Ion Polarity** pull-down menu. See [Figure 184](#).

**Figure 184.** Setting Ion Polarity in a CI Method

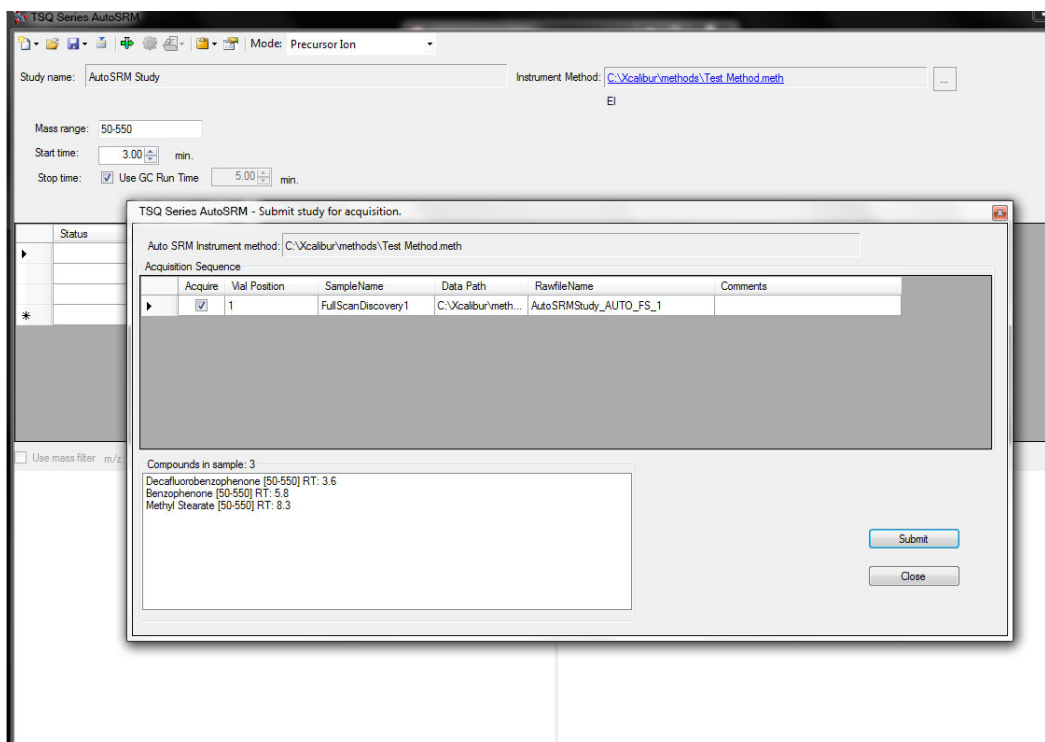


16. Click the **Acquire Data** icon to run your samples. See [Figure 183](#).

**Note** AutoSRM calculates the number of injections needed based on the compound list and vial positions you assigned.

17. The Submit Study for Acquisition window opens. See [Figure 185](#).

**Figure 185.** Submitting a Study for Acquisition





18. Click **Submit** to submit the samples to the instrument.

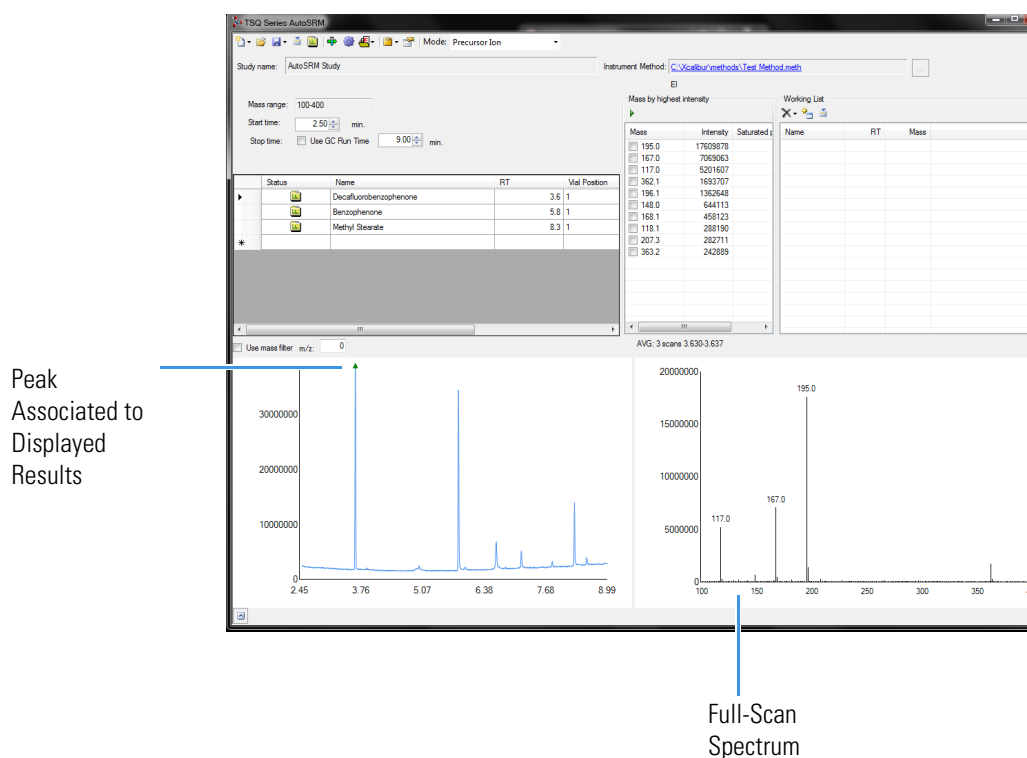
Once the samples have finished running, the software analyzes the data.

19. The results appear in the AutoSRM window. See [Figure 186](#).

The results displayed correspond to the peak topped by the green triangle. The Mass by Highest Intensity pane contains a list the highest intensity ions at the indicated retention time.

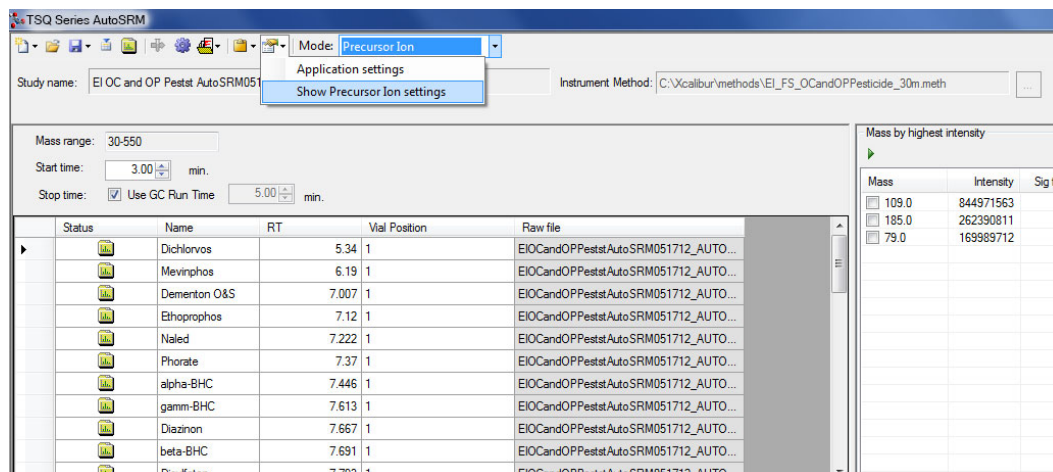
**Note** Background subtraction updates the ions in the Mass by Highest Intensity pane.

**Figure 186.** Study Results in AutoSRM



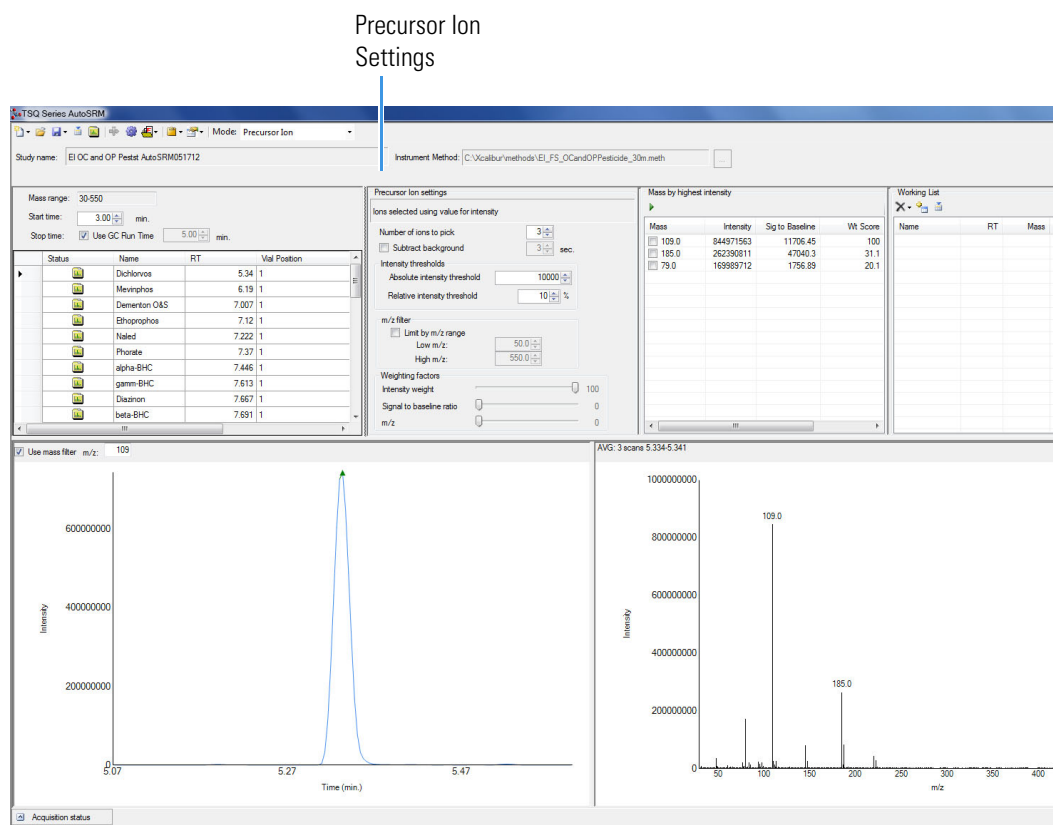
20. Select the check box next to the precursor ions you want to send to the working list or click the settings icon and choose **Show Precursor Ion Settings** to access additional settings for selecting precursor ions. See [Figure 187](#).

Figure 187. Accessing the Precursor Ion Settings



21. The **Precursor Ion Settings** box opens. See Figure 188.

Figure 188. Precursor Ion Settings



22. By default, precursor ions are sorted by highest intensity. In the Precursor Ion Settings box, you may select precursor ions according to the following criteria.

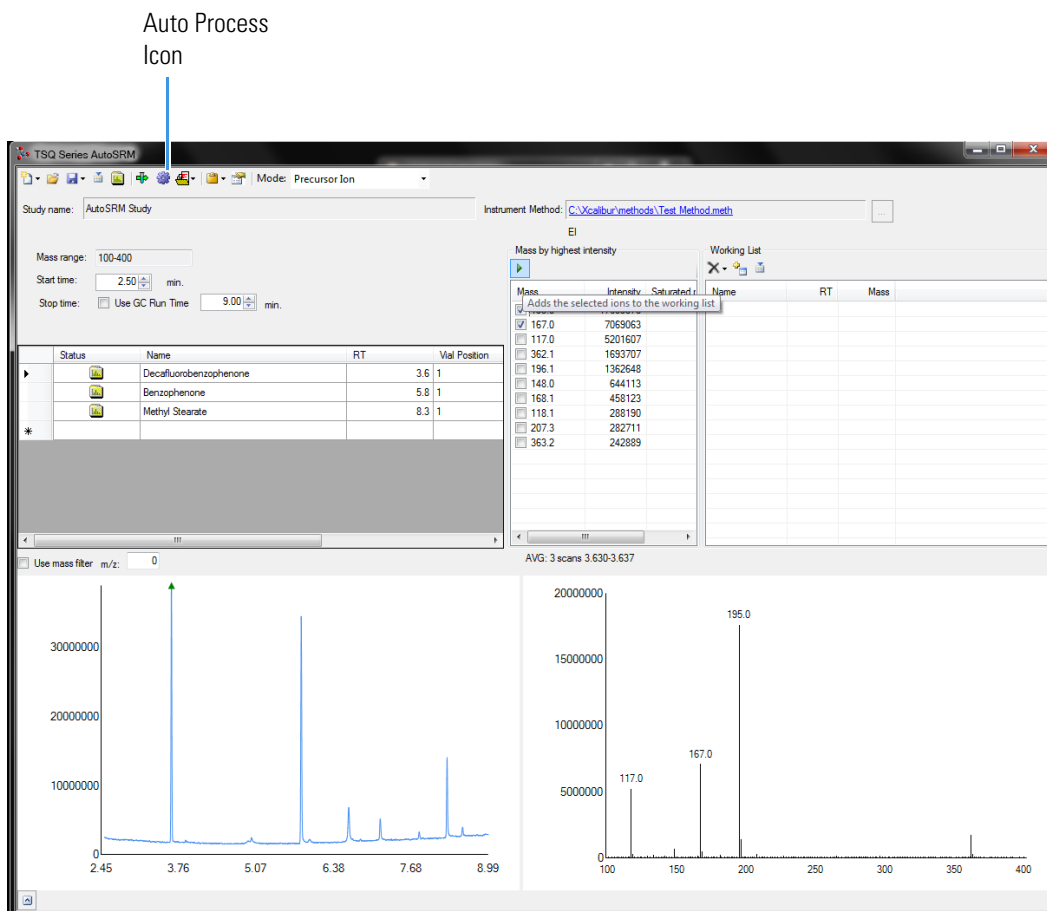
- a. **Number of Ions to Pick:** Selects the number of precursor ions picked for each compound.

- b. **Subtract Background:** Checking this box subtracts background from the spectrum. Subtracting the background may reduce baseline noise automatically away from the selected peak. This will help identify your target compounds, clarify intensities, and may reduce the effects of column bleed. If the automatic background subtraction is not ideal (i.e., due to co-eluting peaks), you may select to manually subtract background for individual compounds by right clicking on the chromatogram and then highlighting the scan or scans to use for subtraction.
- c. **Intensity Thresholds:** Allows you to select precursor ion candidates based on intensity levels.
  - i. **Absolute Intensity Threshold:** Sets the minimum intensity level such that all ions must be greater than this intensity to be selected as precursor ion candidates.
  - ii. **Relative Intensity Threshold:** Sets the minimum intensity of an ion relative to the highest intensity ion to be a candidate for the precursor ion list. Ions must have a relative abundance greater than or equal to this percentage to be selected as precursor ion candidates.
- d. **Limit by  $m/z$  Range:** Check this box and set the low  $m/z$  and high  $m/z$  to limit your precursor ion selection list to certain masses within the set scan range.
- e. **Weighting Factors:** Use the sliding bars and check boxes to set the values you want to give each precursor ion study setting. The available factors are **Intensity Weight** (peak height), **Signal to Baseline Ratio** (peak height/baseline height), and  **$m/z$** . Set the weights of each from 0 to 100, with a total weight of 100.

**Tip** When selecting precursor ions, you often get better results by weighting  $m/z$  higher than intensity weight.

23. Click the green arrow icon to push the precursor ions you selected to the working list. See [Figure 189](#).

**Figure 189.** Selecting Precursor Ions for Product Ion Study



24. Repeat this process for all of your compounds.

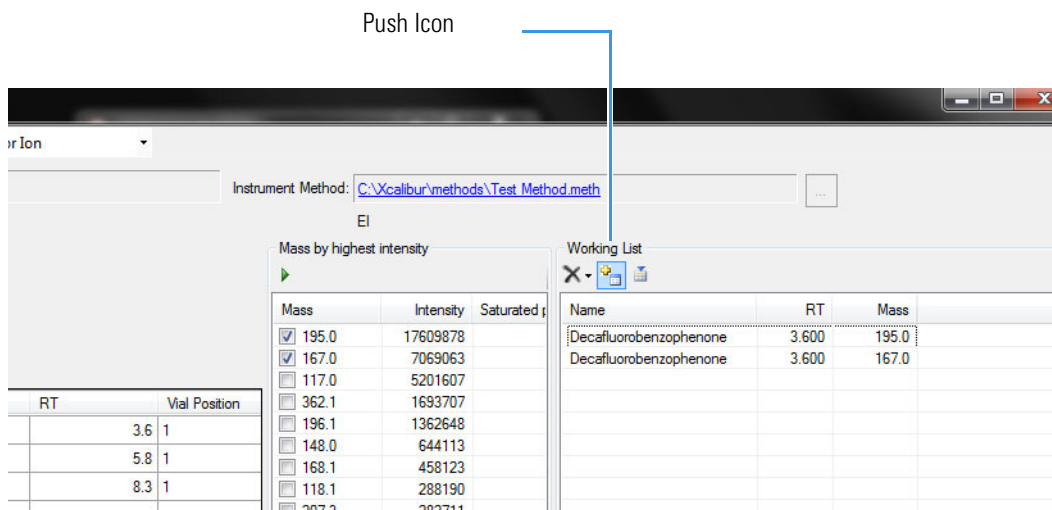
**Note** You can select precursor ions by checking them in the mass list or double-clicking on the ion in the spectra window.

You have obtained your list of precursor ions and are now ready to conduct the product ion study.

**Tip** AutoSRM can select the precursor ions for you if you click the purple Auto Process icon. AutoSRM will pick the highest intensity ions for each compound. The number of ions chosen for each compound can be set in the options window.

25. When you have reviewed all the compounds and selected the precursor ions, click the **Push** icon in the working list (See [Figure 190](#)) to push the transitions in the working list to the Product Ion Study.

Figure 190. Pushing Compounds in Working List to Product Ion Study



## Conducting the Product Ion Study

Now that you have selected your precursor masses, you can find the product masses. AutoSRM instructs the GC-MS system to acquire product ion scans of your precursor masses at three collision energies. You do not have to set up any methods, sequences, or data layouts; AutoSRM automatically does these for you. Also, the software instructs the autosampler to make multiple injections if compound retention times are too close or if multiple precursor ions are selected for a single compound.

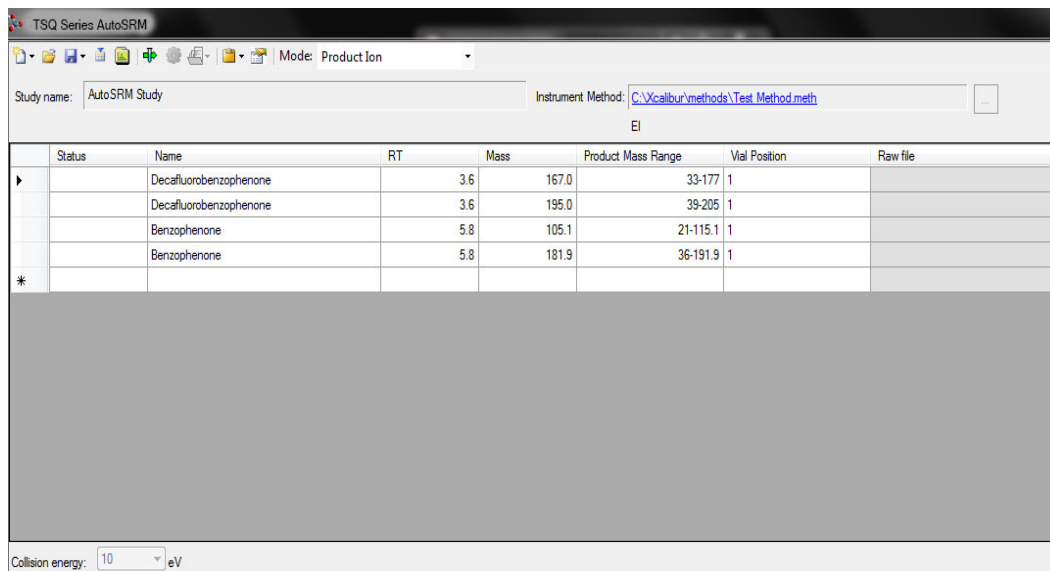
Along with your chromatographic peak and your product ion spectra, AutoSRM presents you with a table of the most intense product ion masses from which to choose. If you prefer, AutoSRM can select the product ion masses for you.

**Tip** You can import a SIM method directly into this step by clicking the **Import** icon. The import file must be in the same .csv format that the TSQ 9610 instrument method exports through its Export Timed Transitions function.

### ❖ To conduct a product ion study, use the following steps

1. The AutoSRM window displays the list of precursor ions you selected for the Product Ion study.

**Figure 191.** Precursor Ions Selected for Product Ion Study



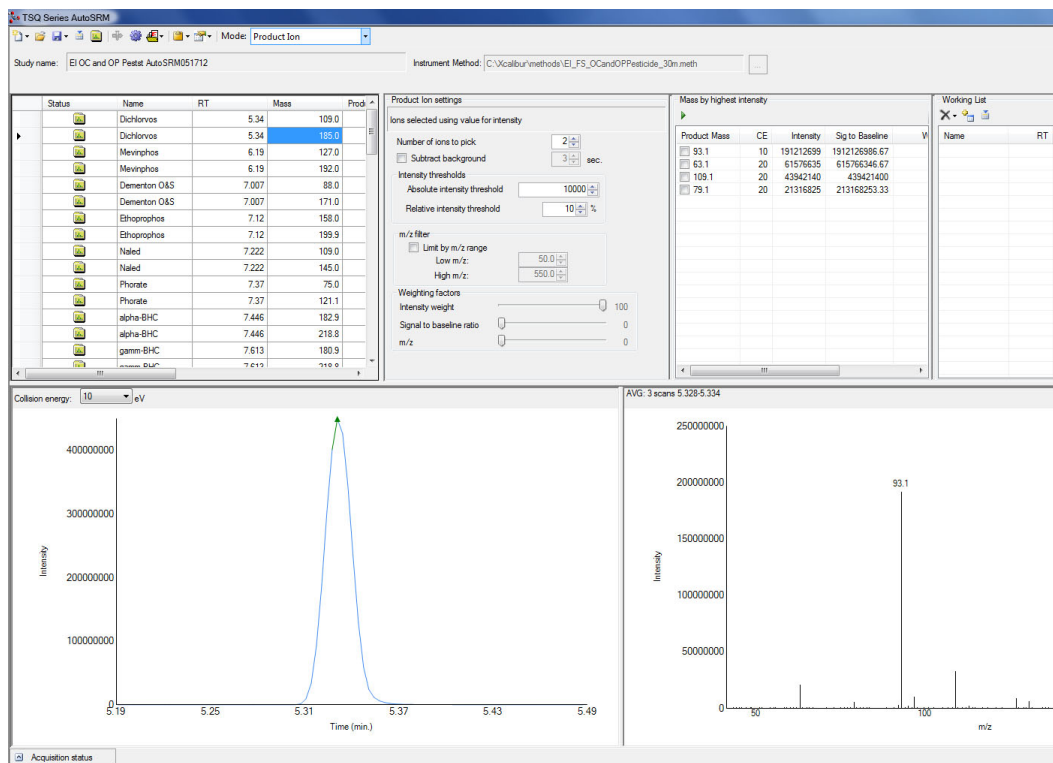
2. Click the Settings icon to access the product ion settings. See [Figure 192](#).

**Figure 192.** Accessing Product Ion Settings



3. The Product Ion Settings box opens. See [Figure 193](#).

Figure 193. Product Ion Settings



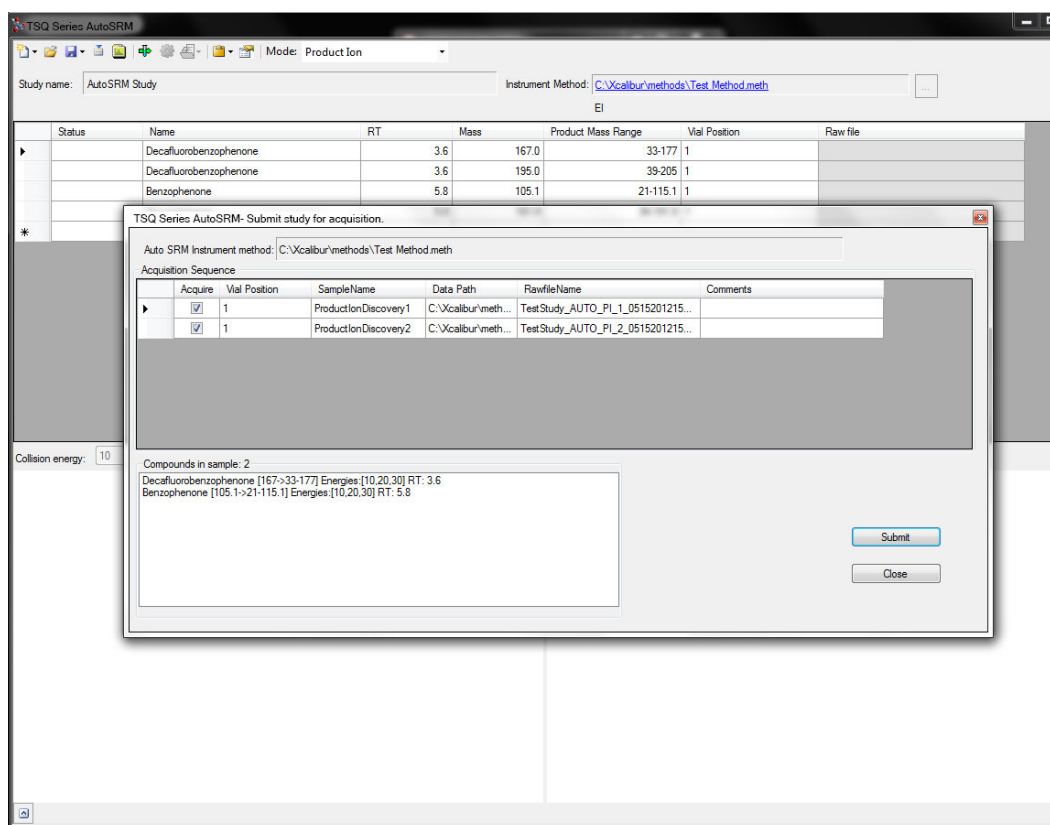
4. By default, product ions are sorted by highest intensity. In the Product Ion Settings box, you may select product ions according to the following criteria.
  - a. **Number of Ions to Pick:** Selects the number of product ions picked for each compound.
  - b. **Subtract Background:** Checking this box subtracts background from the spectrum. Subtracting the background may reduce baseline noise automatically away from the selected peak. This will help identify your target compounds, clarify intensities, and reduce the effects of column bleed. If the automatic background subtraction is not ideal (i.e., due to co-eluting peaks), you may select to manually subtract background for individual compounds by right clicking on the chromatogram and then highlighting the scan or scans to use for subtraction.
  - c. **Intensity Thresholds:** Allows you to use intensity levels.
    - i. **Absolute Intensity Threshold:** Sets the minimum intensity level such that all ions must be greater than this intensity to be selected as precursor ion candidates.
    - ii. **Relative Intensity Threshold:** Sets the minimum intensity of an ion relative to the highest intensity ion to be a candidate for the precursor ion list. Ions must have a relative abundance greater than or equal to this percentage to be selected as precursor ion candidates.
  - d. **Limit by m/z Range:** Check this box and set the low m/z and high m/z to limit your product ion selection list to certain masses within the set scan range.

- e. **Weighting Factors:** Use the sliding bars and check boxes to set the values you want to give each product ion study setting. The available factors are **Intensity Weight** (peak height), **Signal to Baseline Ratio** (peak height/baseline height), and ***m/z***. Set the weights of each from 0 to 100, with a total weight of 100.

**Tip** When selecting product ions, you often get better results by weighting intensity weight higher than *m/z*.

5. Review the product ion list and update the vial numbers if necessary.
6. Save the study by clicking the **Save** icon.
7. Click the green **Acquire Data** icon to submit the study for acquisition.
8. Click Submit. See [Figure 194](#).

**Figure 194.** Submitting Precursor Ions to Product Ion Study



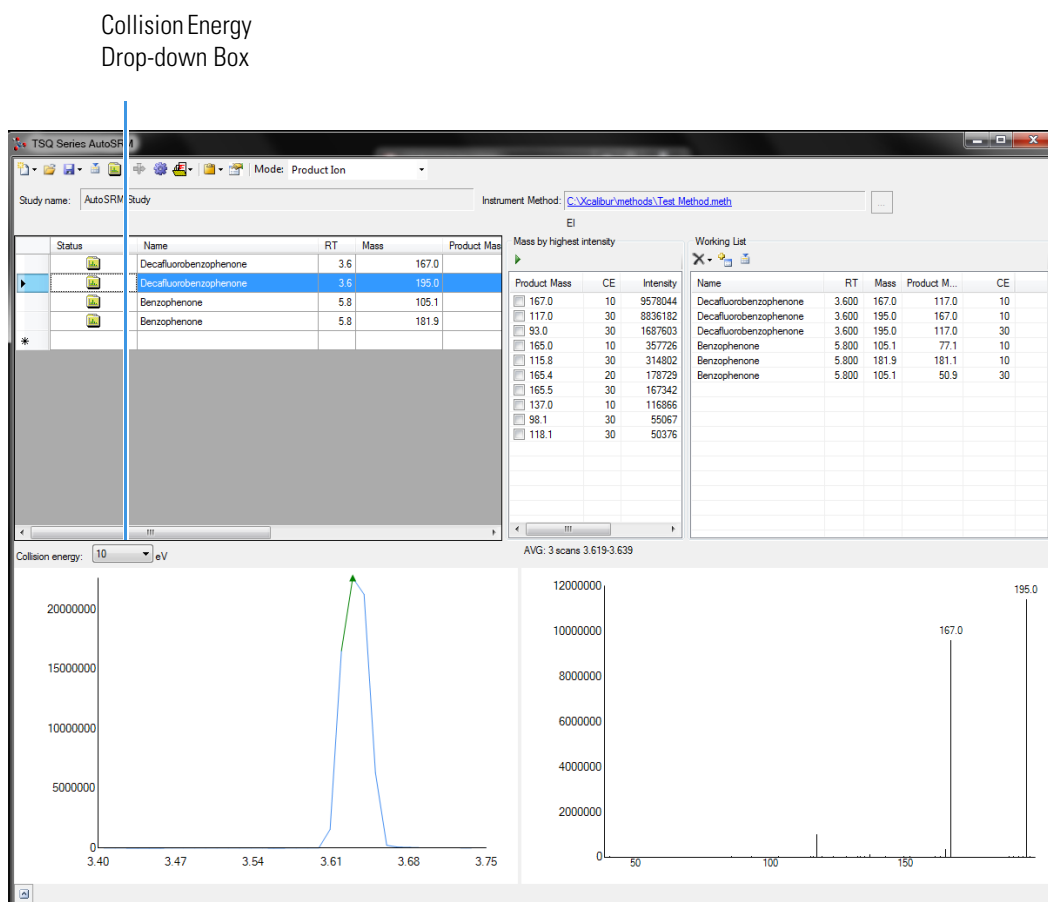
AutoSRM calculates the number of injections needed based on the compound list and vial positions you assigned.

During the Product Ion study, each product ion scans at 10, 20, and 30 eV collision energies to get a good collision energy range over which to search for the best product ions.



- Select the different collision energies from the drop-down box to view the product ions produced at different collision energies. See [Figure 195](#).

**Figure 195.** Selecting Collision Energies

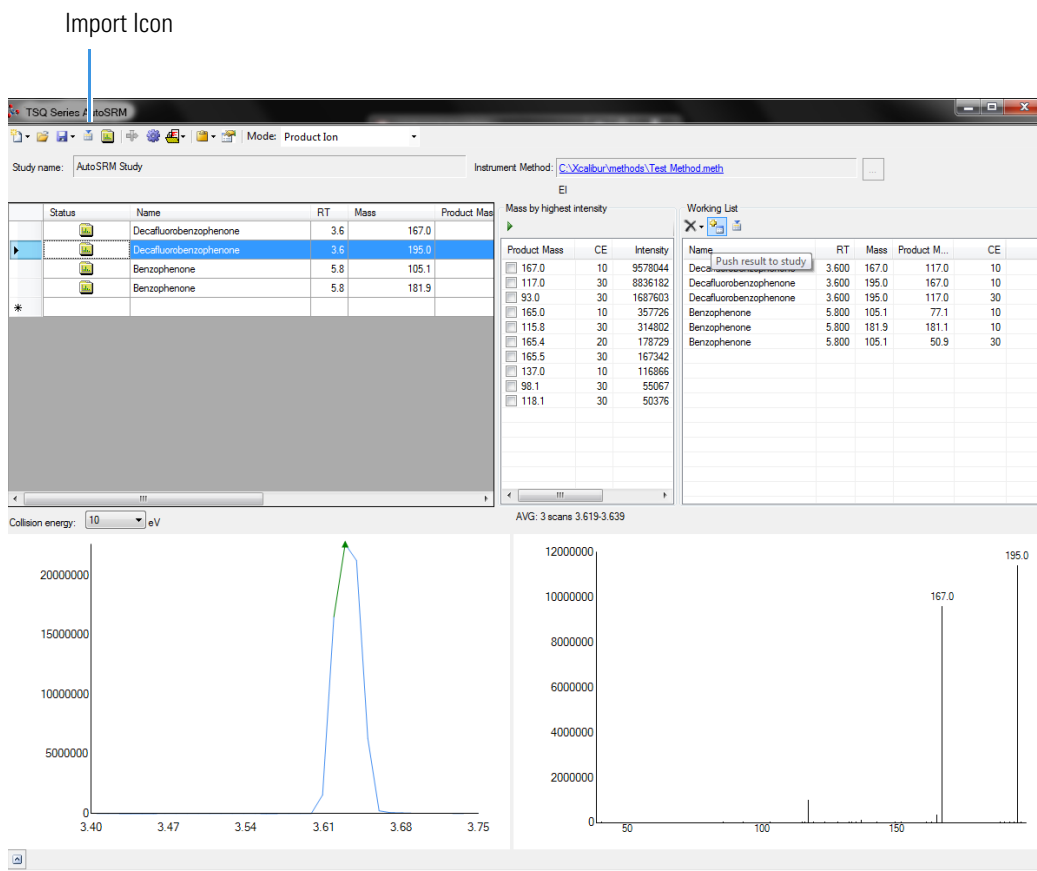


- Choose the product ions and collision energies you want for SRM optimization and push them to the working list. See [Figure 196](#).

**Note** AutoSRM lists product ions in order of highest energy intensity and at the optimal collision energy for each product ion.

**Tip** AutoSRM automatically processes the data for you and suggests transitions if you push the purple wheel icon.

**Figure 196.** Pushing Product Ions to Working List for SRM Optimization



From this point you may export your transition list to your instrument method, or you may send your selected transitions to an SRM optimization study for further optimization.

## Developing the SRM Optimization Study

The final step in SRM development is the SRM optimization step. Now that you have selected precursor and product masses, AutoSRM acquires those transitions at multiple collision energies. Because of the fast scanning capabilities of the GC-MS system, it has the ability to analyze three transitions per compound, each at 10 unique collision energies, in a single injection.

### ❖ To develop a SRM optimization study

1. Push the working list of precursor ions to the SRM optimization study.

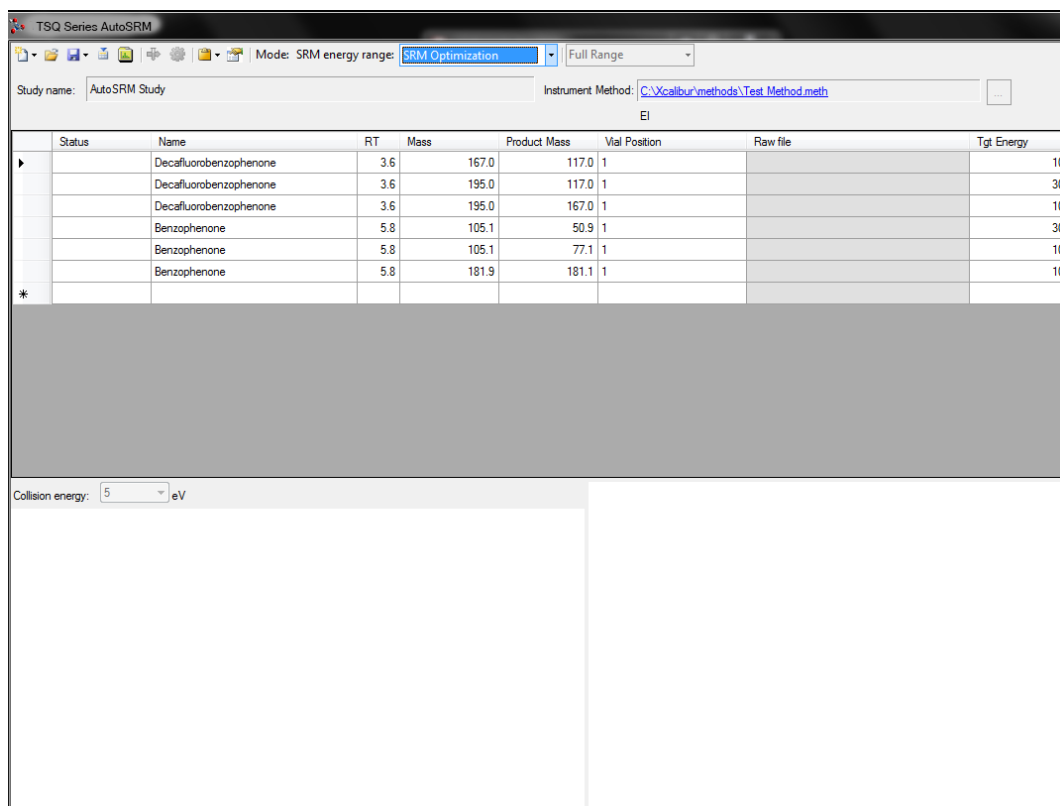
**Tip** You can import an SRM method directly into this step by clicking the Import icon. The import file must be in the same .csv format that the TSQ 9610 instrument method exports through its Export Timed Transitions function.

2. Select Targeted or Full Range study in the SRM Energy Range drop-down box. See [Figure 197](#).

Targeted optimizations use a collision energy range that is 10 eV on either side of the target energy in 2 eV steps. Full Range optimizations use collision energies from 5 to 50 eV in 5 eV steps.

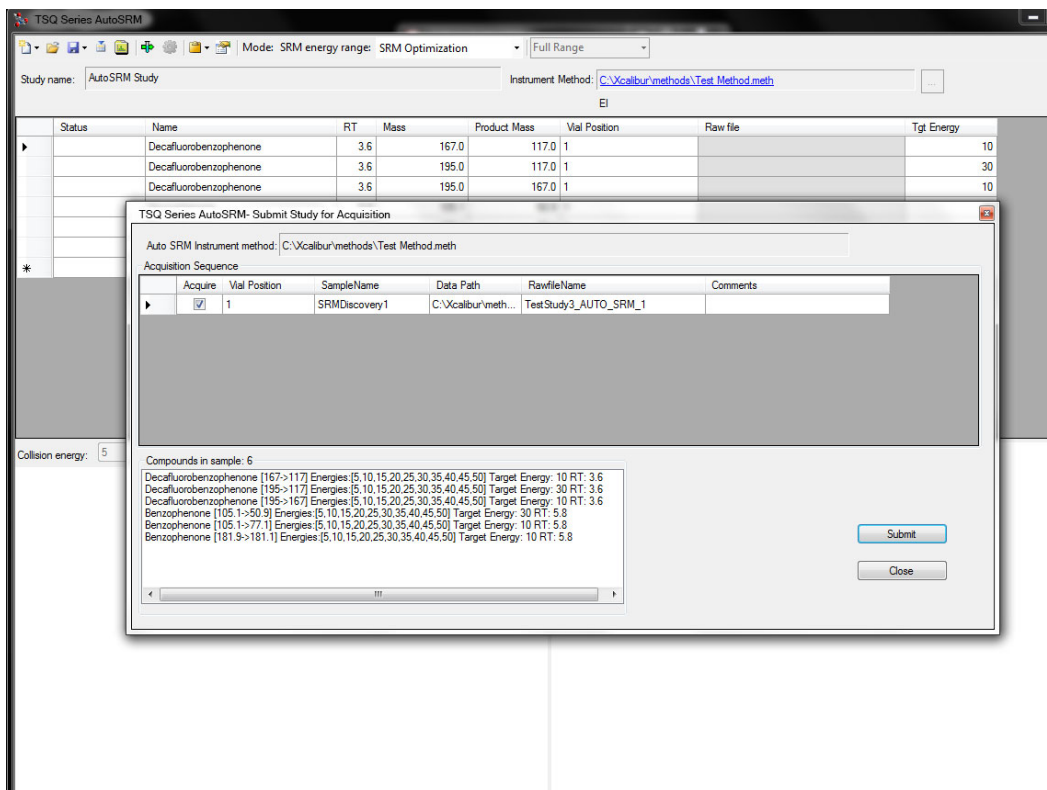
**Note** A single study cannot perform both Full Range and Targeted studies. If you want to do both, you must create a separate study. This can be accomplished through the Create New Study from Existing Study function.

**Figure 197.** Selecting SRM Energy Range



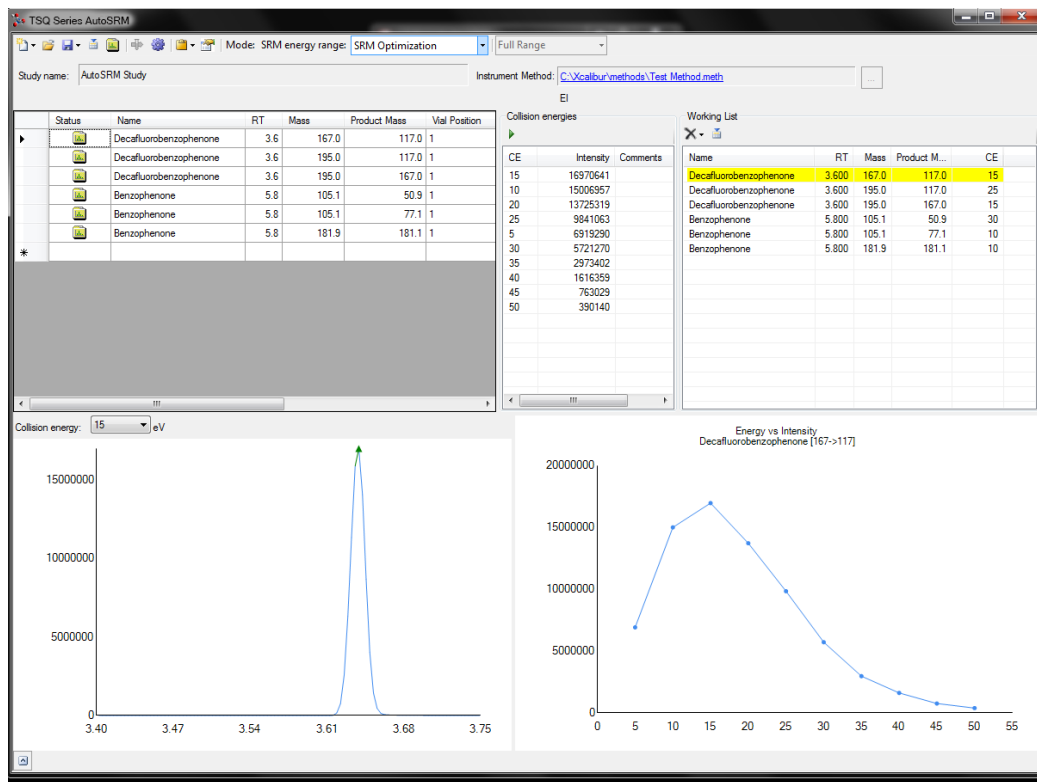
3. Save the study and submit the samples for analysis. See [Figure 198](#).

**Figure 198.** Submitting SRM Optimization Study for Analysis



- Once the analysis is complete, the software displays the data for the user to perform a final review. See [Figure 199](#).

**Figure 199.** Reviewing your SRM Optimization Data

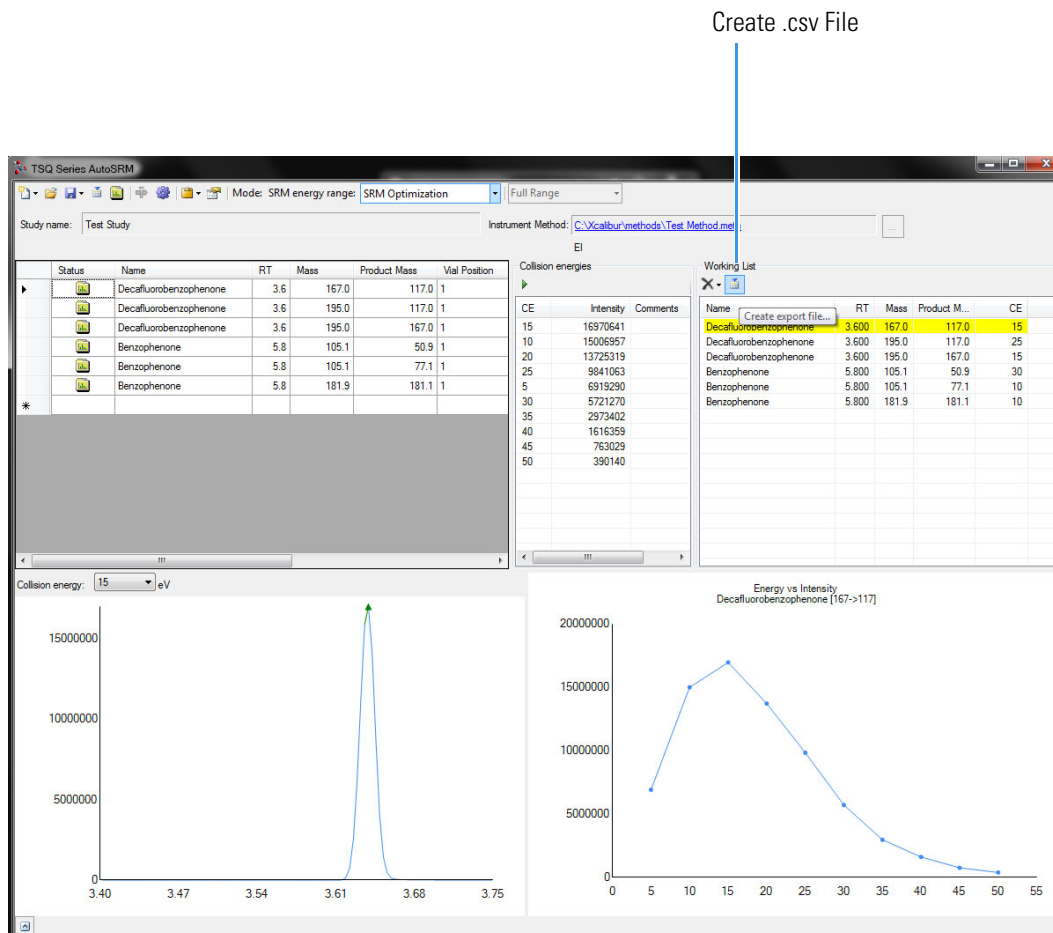


5. Review each transition and push the best collision energy to the working list.

**Note** The software will choose the peak with the highest intensity. If compounds with similar retention times share transitions, you might need to select the appropriate peak using the green triangle.

6. Once you have reviewed the data and chosen the transitions you want to use, save the study and create a .csv file to transfer the transitions to your instrument method. See [Figure 200](#).

Figure 200. Creating File to Transfer Transitions



Once complete, AutoSRM allows the simple creation of a TSQ 9610 instrument method to be ready for routine analysis.

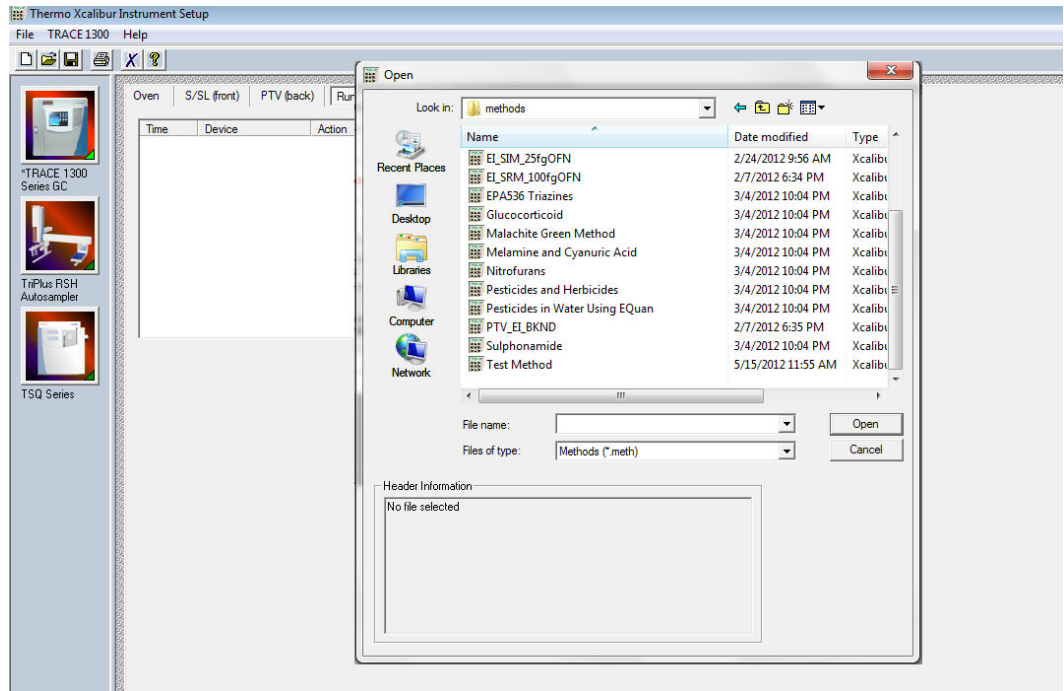
## Importing Transitions to the Method Editor

❖ **To import the list of transitions you created in AutoSRM**

1. Open the method editor on the TSQ 9610 Dashboard.
2. Open your method in the TSQ 9610 method editor. See [Figure 201](#).

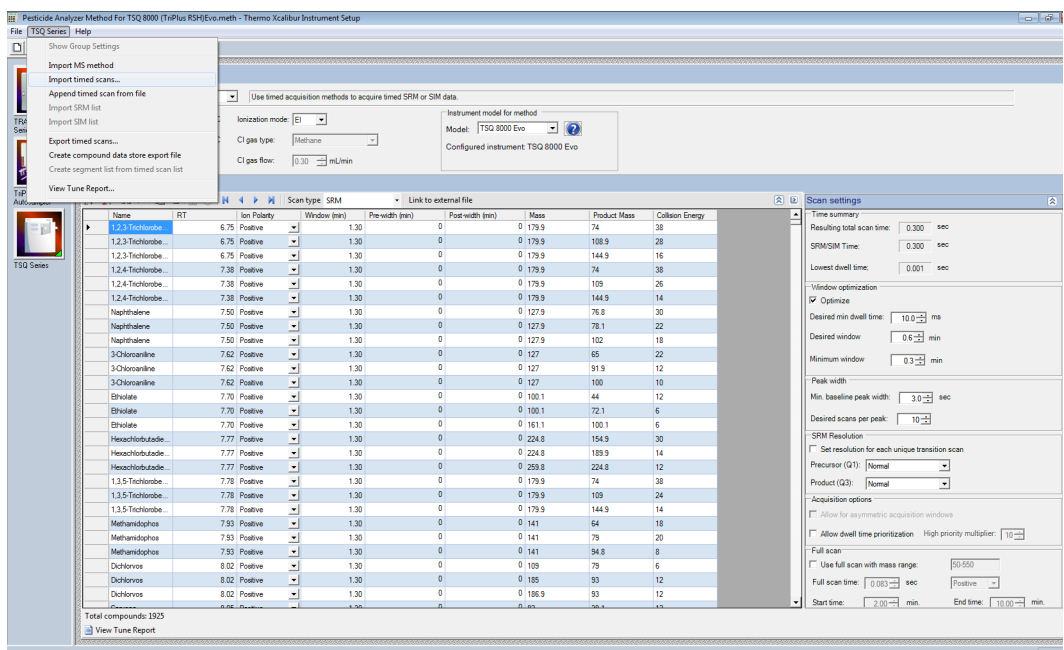
**Note** If you have the desired method open in AutoSRM, click the link in the Instrument Method box to open your method in the TSQ 9610 method editor.

**Figure 201.** Opening Instrument Method in Method Editor



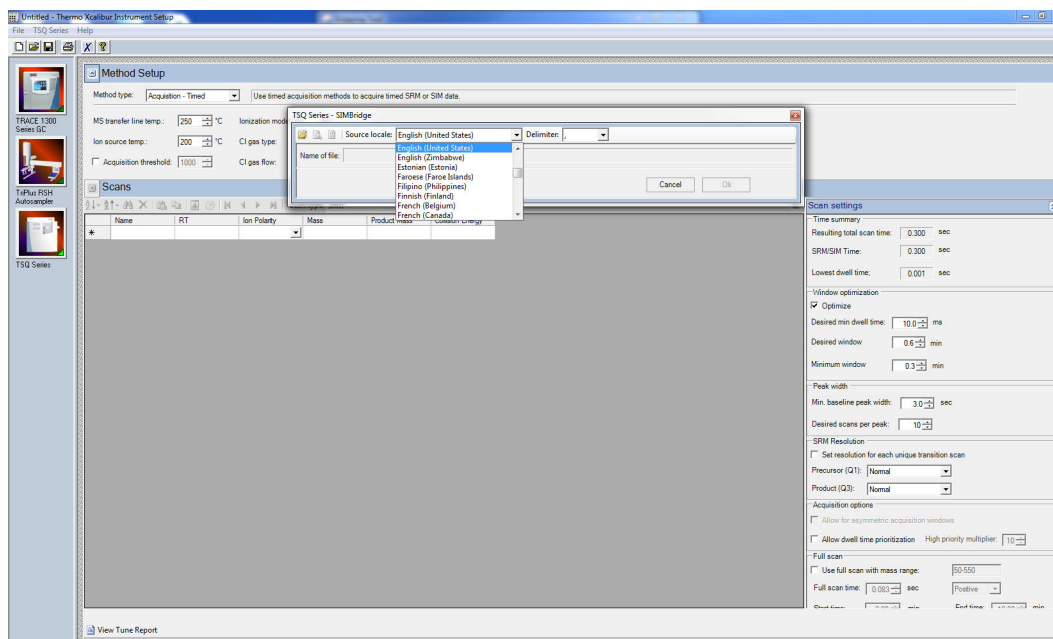
3. Click the TSQ 9610 icon in the method editor side pane.
4. Select Acquisition-Timed from the Method Type drop-down menu.
5. From the top menu, select **TSQ 9610 | Import Timed Scans**. See [Figure 202](#).

**Figure 202.** Opening Timed Scans in the TSQ 9610 Method Editor



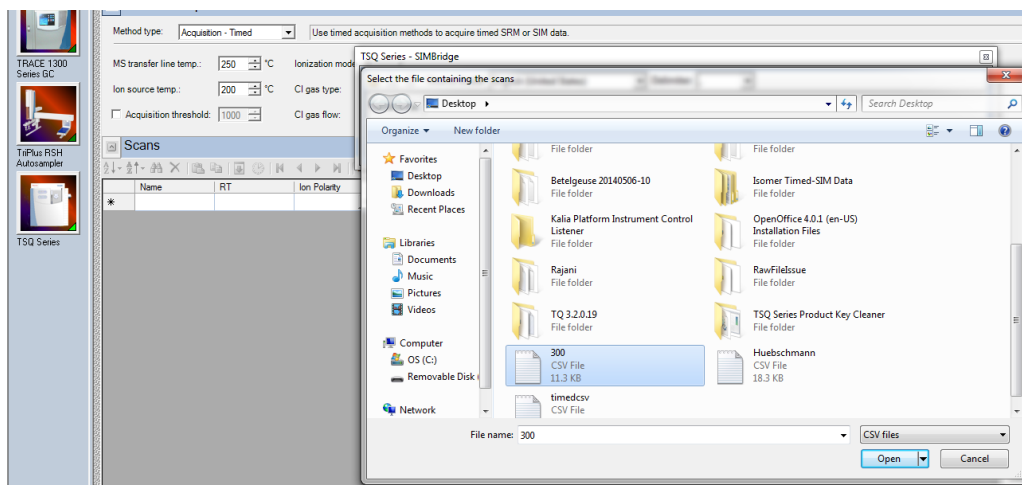
- a. Browse to the location where you saved the .csv file you created in AutoSRM. The **SIMBridge** dialog box opens. Choose the language of your method file from the **Source Locale** drop-down menu. See [Figure 203](#).

**Figure 203.** Setting the Source Language of Method Files using SIMBridge



- b. Browse to your file. See [Figure 204](#).

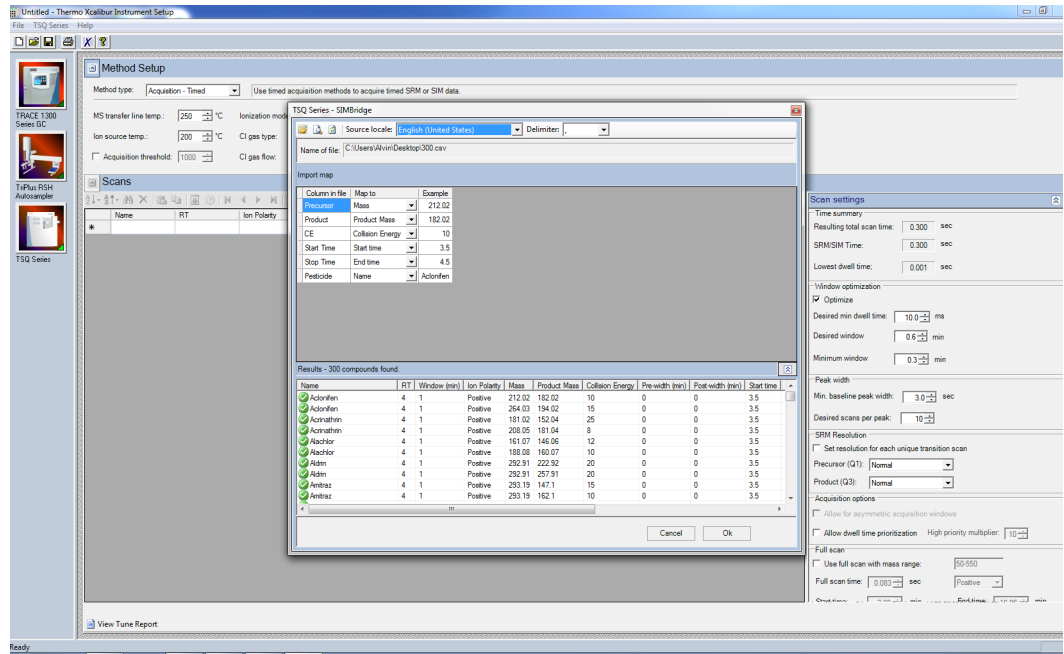
**Figure 204.** Linking to an External File using SIM Bridge



- c. Click **Open** to open the method in SIMBridge.
- d. If necessary, change the method headings in your original file to match those in the method editor. A green check mark appears when your method is validated. See [Figure 205](#).

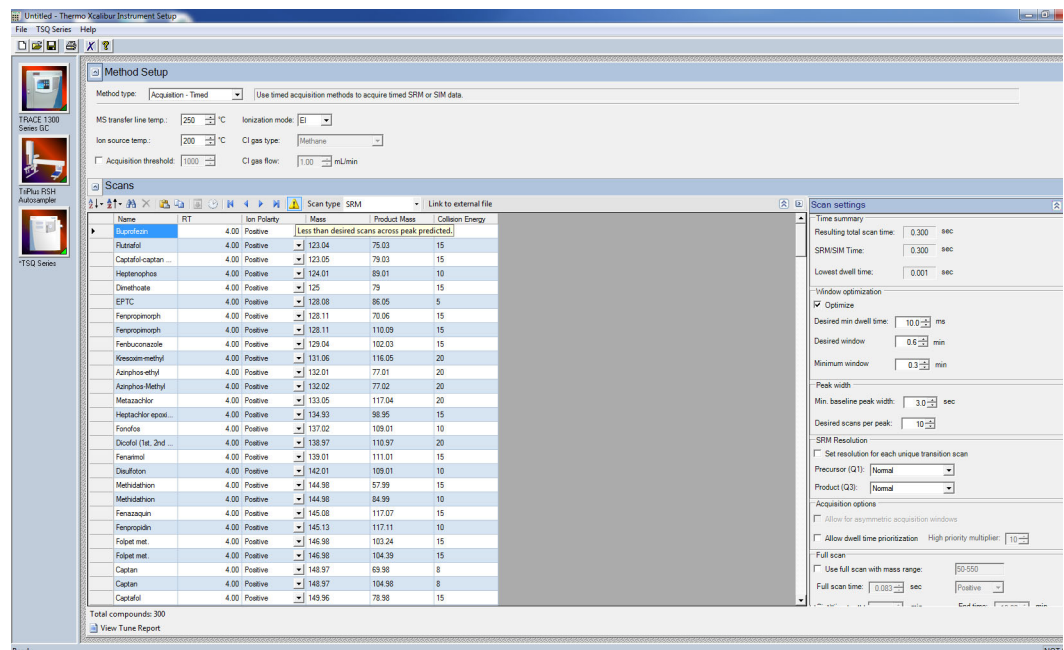


Figure 205. Changing Method Headings in SIMBridge



- e. Click **Open** and your linked AutoSRM method will be opened in the method editor. See Figure 206.

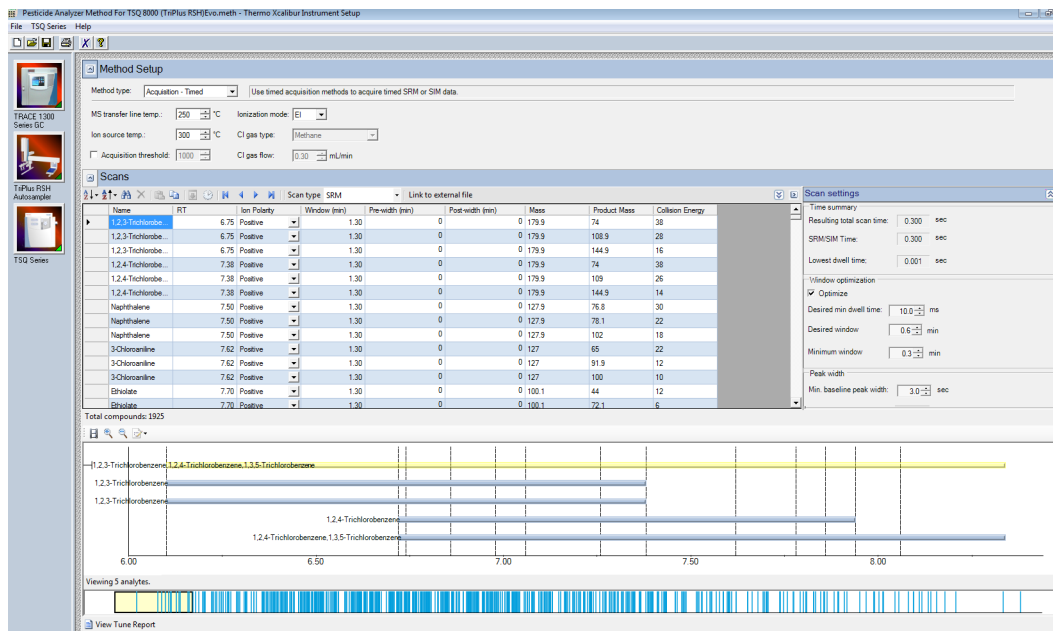
Figure 206. Viewing the AutoSRM File in the Method Editor



- f. If you open an older model TSQ 8000, a TSQ 8000 Evo, or a TSQ Duo method, the **Instrument Model for Method** box appears.
- g. Select your model from the drop-down menu in **Instrument Model for Method** in order to make the imported method compatible with your model.

6. Click **Show Analysis** and review the imported list of compounds.
7. Adjust your scan settings as necessary. See the user guide for more information.

**Figure 207.** Review Imported List



8. Once you are satisfied with your method, save it.
9. Run a set of samples to verify that the method meets your needs.

## Computer Settings

Your TSQ 9610 system includes a computer with all the software needed to operate the instrument.

If you replace the computer in the future, use the information in this chapter to change the computer settings so your TSQ 9610 system and the associated Thermo Scientific software will run correctly. Instructions for installing Thermo Scientific software are included on the software CD shipped with your instrument.

### Contents

- [System Requirements](#)
- [Computer Settings](#)
- [Excluding the Xcalibur Directory from Virus Scan](#)

## System Requirements

The TSQ 9610 system requires a Windows 7 or Windows 10 32-bit or 64-bit operating system. See “[System Requirements](#)” on [page xvi](#) for a complete list of system requirements.

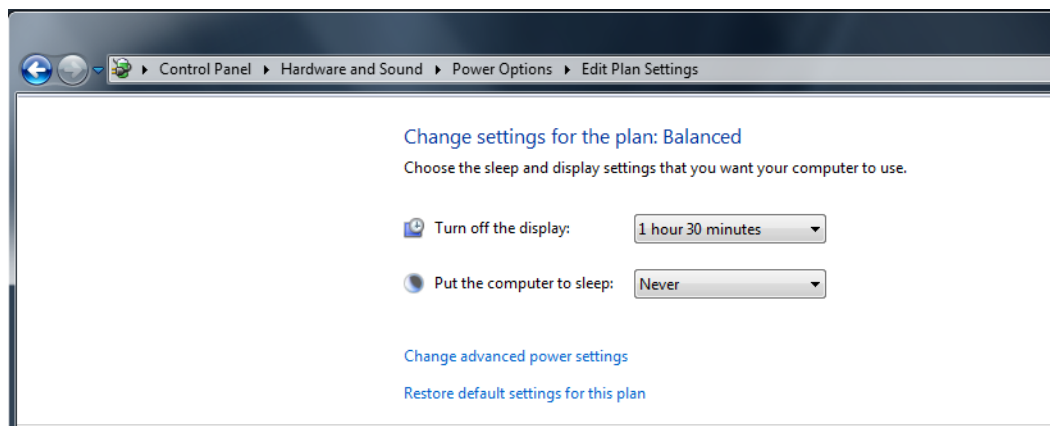
## Computer Settings

The following computer settings will help prevent communication interruptions in your TSQ 9610 system.

### ❖ To use the power save feature

1. From the **Start** menu choose **Control Panel | System and Security | Power Options**.
2. On the left side, click **Change When the Computer Sleeps**.
3. For **Put the Computer to Sleep**, select **Never**. See [Figure 208](#). You may set the display to turn off at any time. It will not affect the performance of your TSQ 9610 system.

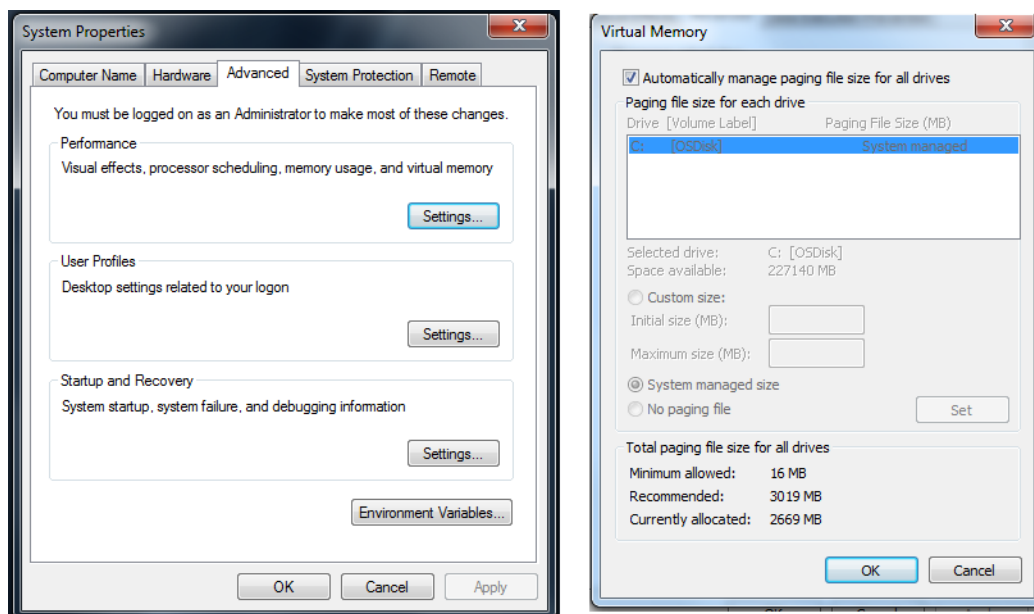
Figure 208. Power Settings for the Computer



❖ **To use the virtual memory feature**

1. From the **Start** menu, choose **Control Panel | System and Security | System**.
2. On the left side of the window, click **Advanced System Settings**.
3. In the System Properties dialog box, click **Settings**.
4. In the Performance Options dialog box, click the **Advanced** tab, and then click **Change** to open the Virtual Memory window.
5. Confirm that **Automatically Manage Paging File Size for All Drives** check box is selected. See Figure 209.

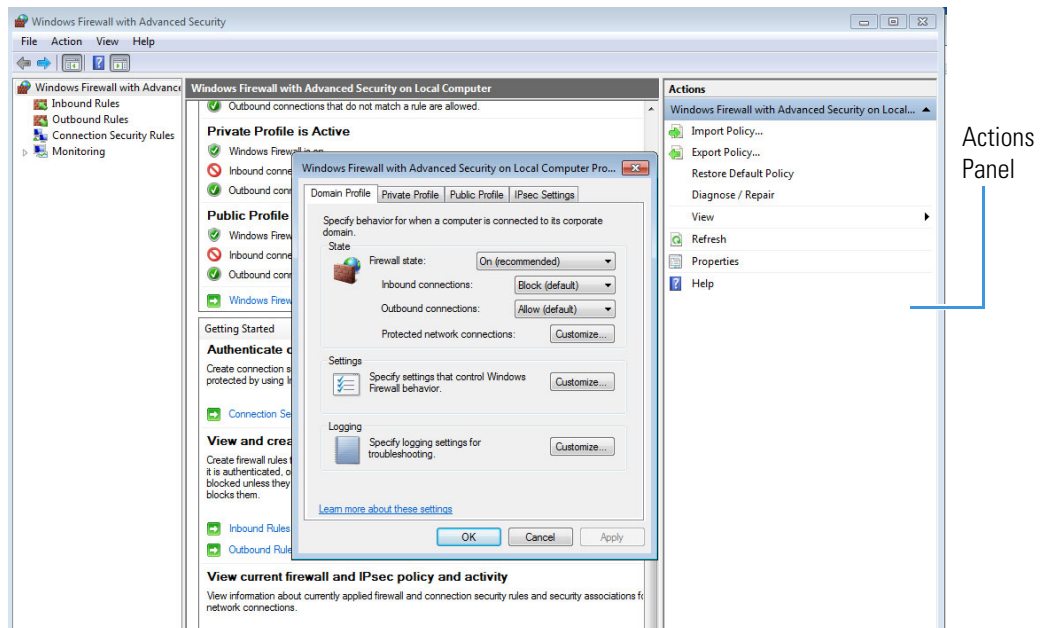
Figure 209. Virtual Memory Settings



❖ **To confirm the network card firewall settings**

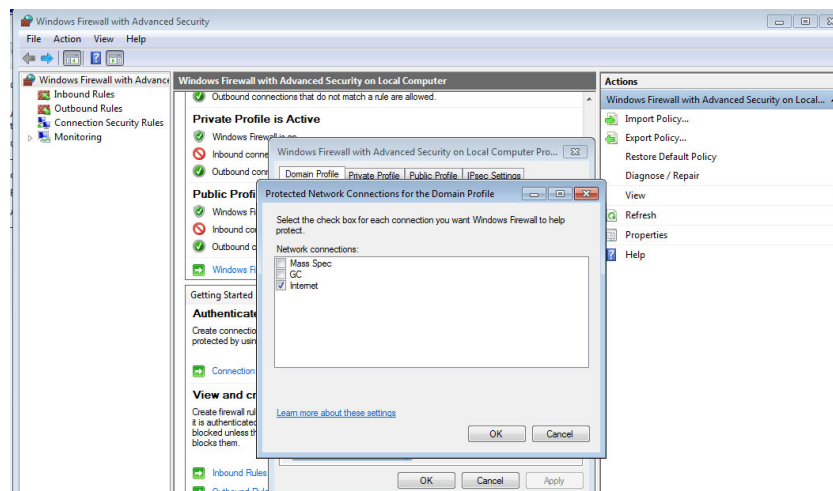
1. From the **Start** menu, choose **Control Panel | Network and Internet | System and Security | Windows Firewall | Advanced Settings**.
2. In the **Actions Panel** on the right, (see [Figure](#) ), select **Properties**.
3. In the **Windows Firewall with Advanced Security on Local Computer Properties** window, select **Domain Profile | State | Customize**.

**Figure 210.** Firewall Settings for the TSQ 9610 System Computer



4. In the **Protected Connections for the Domain Profile** window, make sure that any instrument checkboxes are not checked.

**Figure 211.** Setting the Network Connections



# Excluding the Xcalibur Directory from Virus Scan

If you are using anti-virus software on your computer, exclude the following folders from scanning:

- **C:\Program Files\Thermo\**
- **C:\Thermo\**
- **C:\Xcalibur\**

Failure to exclude these folders might cause interruptions in data acquisition. If you must, for security reasons, scan all system files, set the virus scans so that they occur when you are not using the instrument to acquire data.

# Troubleshooting

This section contains information to help you diagnose problems within your data. Sometimes, your experience as a scientist will enable you to look at your data and detect that something is wrong either with the instrument or your sample. This chapter describes the most common indications of a problem with a baseline, peak or result.

## Contents

- [Setting Instrument Conditions for Troubleshooting](#)
- [Checking Air/Water Spectra](#)
- [Diagnostics Checks](#)
- [Resetting Chromeleon after Replacing a Blown Filament](#)
- [How to Know When Your System Needs Maintenance](#)
- [Investigating Baseline Issues](#)
- [Investigating Peak Issues](#)
- [Investigating Results Issues](#)

If there is an issue with the hardware, see the troubleshooting section of the hardware manual.



**CAUTION ELECTRICAL SHOCK HAZARD:** When troubleshooting any issue that requires removing a cover on the instrument, power-off and vent the instrument to avoid possible injury.



**ATTENTION RISQUE D'ÉLECTROCUTION :** lorsque vous cherchez à résoudre un problème nécessitant d'enlever le couvercle de l'instrument, mettez hors tension et ventilez l'instrument pour éviter tout risque de blessure.

You can begin troubleshooting by running a tune with diagnostics on the instrument. If you have good ion intensities, good peak shapes, and no air leak, you might want to look first at the GC, autosampler, or carrier gas.

If you have air leaks, locate and address them. Pay particular attention to the transfer line ferrule, vent valve knob, front panel, gas quality, carrier gas vacuum compensation, source plug, and vacuum interlock on the mass spectrometer, as well as the inlet on the GC.

If your intensities are too low, make sure carrier vacuum compensation is turned on.

**IMPORTANT** When inserting a cold ion source cartridge such as after cleaning or when switching between EI and CI modes, the ion source and lens stack will expand as the source cartridge heats, often pushing the ion volume and lenses away from the rear of the instrument where they are firmly held by the RF Lens spring contacts. To avoid intermittent electrical contacts to the lenses, you should insert the ion source cartridge, wait 30 min for it to get to temperature, then remove and reinsert it. See the hardware manual for instructions on cleaning and inserting the ion source cartridge.

If you have no ions in full-scan or SIM mode, do the following:

- Switch filaments.
- Confirm the starting tune file is appropriate for ionization mode or source cleanliness level.
- Confirm the correct ion volume is inserted (EI or CI).
- Verify the ion source is correctly installed.
- Run diagnostic checks (Diagnostics Only tune type)
- Clean the ion source.

If you do not see ions in CI mode:

- Confirm that the CI ion volume is installed.
- Confirm that the reagent gas is connected and turned on.

If you do not see any peaks in SRM scans, do the following:

- Verify the collision gas supply.
- Run diagnostics checks (Diagnostics Only tune type).
- Run a full-scan method to check if your system is functional.

## Setting Instrument Conditions for Troubleshooting

Before troubleshooting the system, set the instrument to the conditions in this section in order to compare your system more accurately to the values in the section. All troubleshooting should be performed in EI mode. Once EI mode is working, check CI conditions if relevant.



**IMPORTANT** Use only Nitrile Cleanroom gloves when touching ion source components. Other types of gloves deposit contaminants on the source components that affect system performance. See the *TSQ 9610 Spare Parts Guide* for ordering information.

- Clean the ion source cartridge. See the *TSQ 9610 Hardware Manual* for instructions.
- Install a 15 m × 0.25 mm × 0.25 μm GC column (If using a different column, pressure readings may vary.)
- Ion Source Temperature — 200 °C
- Transfer Line Temperature — 250 °C
- Vacuum Compensation — On
- Column Flow Rate — 1.5 mL/min
- Foreline Pressure — < 100 mTorr

**Note** Foreline pressure is a function of how long the interior of the manifold has been exposed to the atmosphere, the pumping capacity of the turbo pump, length of the foreline hose, and other criteria. As an example, if the system has been recently exposed to atmosphere, the foreline pressure will be above the expected value. Foreline pressure is not set by the user, but the value above needs to be reached prior to troubleshooting.

- Pump down the system according to the time recommended for the turbomolecular pump installed on it.
- Air/Water Check — Water ( $m/z$  18/69) < 300%

Once you have applied the settings in this section, and have allowed the system to equilibrate, run an EI diagnostic tune even if you cannot see any ion intensities.

## Checking Air/Water Spectra

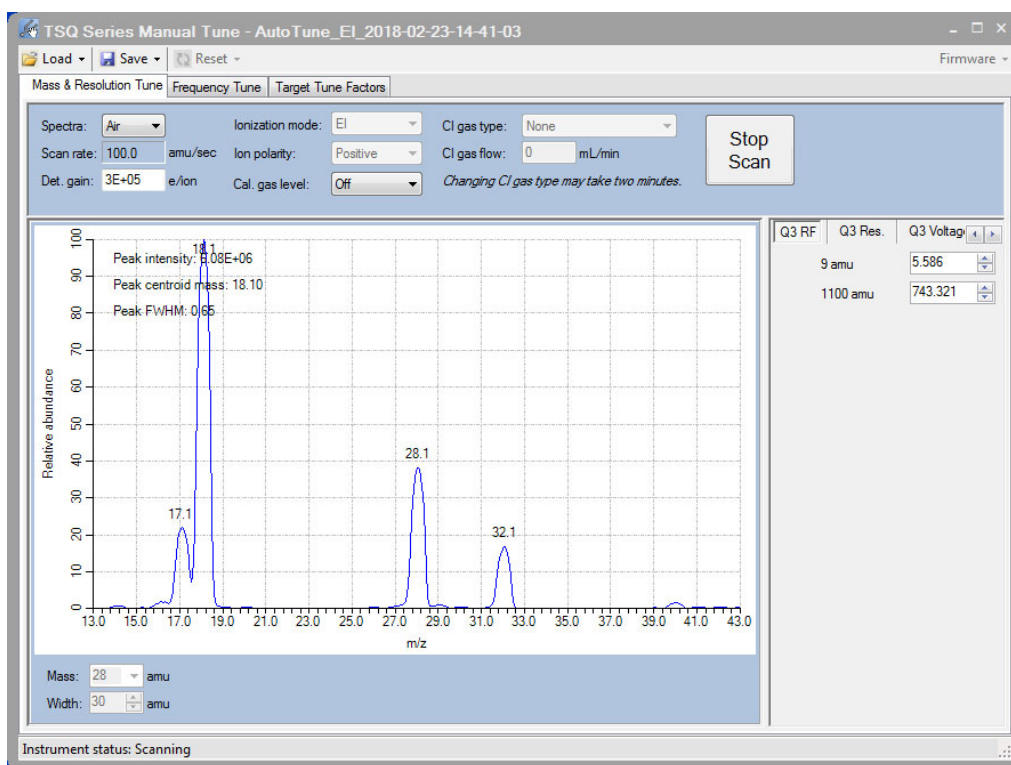
**Note** If using the AEI source or NeverVent AEI ion source, the air & water background ions may be too intense to observe without saturating the detector. Do not continue to scan when the detector is saturated or it will reduce detector lifetime. Make note of the detector gain and lower it (you may also find the last tuned value from the most recent tune report). If the intensity is above  $1 \times 10^9$ , decrease the emission current to 5 μA and reduce the detector gain to observe unsaturated ions. Be careful to set the detector gain back to the last tuned value in manual tune before running a sample method that uses last tune detector gain. Manual tune saves the detector gain to the instrument, and it can be used by subsequent methods.

Before running additional diagnostics, check the air/water spectra of your system in the TSQ Series Manual Tune utility and use the information in this section to troubleshoot your system.

❖ **To check Air/Water spectra on the TSQ 9610 system**

1. Open the TSQ Series Dashboard on Xcalibur or the TSQ ePanel in Chromeleon and click **Tuning**.
2. Click **Air & Water /Tune** and check the air spectrum. See [Figure 212](#).

**Figure 212.** Typical TSQ 9610 Air/Water Spectrum with Helium Carrier Gas at 1.2mL/min



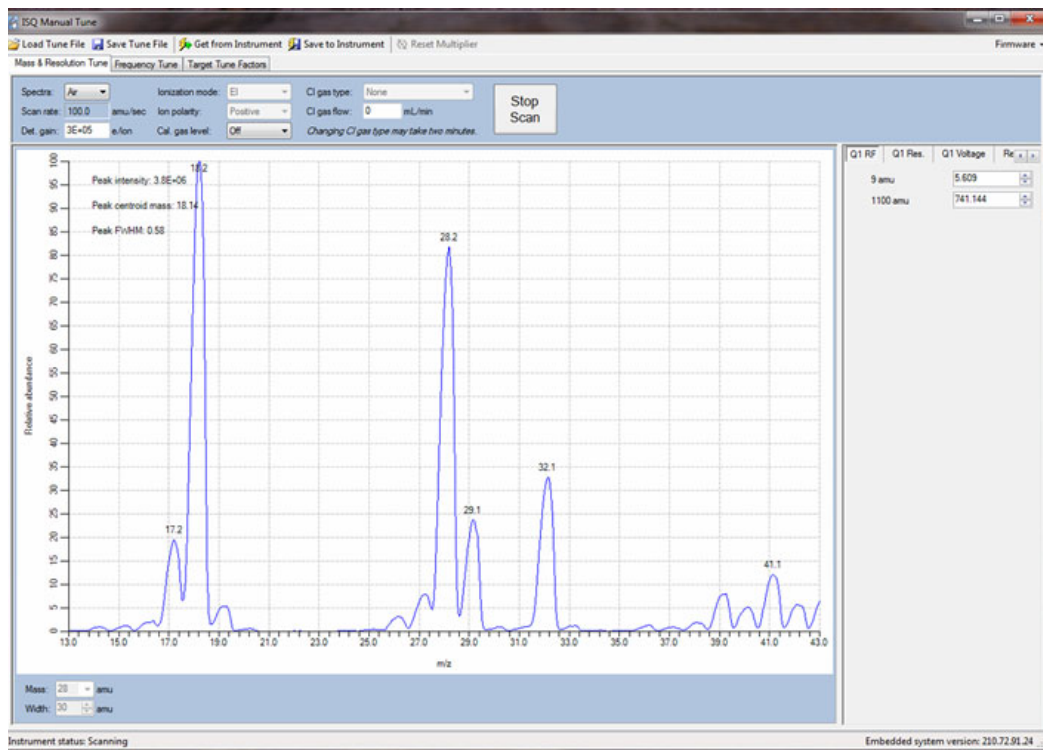
The typical results (with helium carrier gas flow at 1.2mL/min) are:

- Detector Gain =  $3 \times 10^5$
- Peak Intensity >  $3 \times 10^6$
- Normal ions are present and in acceptable ratios:
  - 18 (Water) — 20–300% of N<sub>2</sub>
  - 28 (N<sub>2</sub>) — Reference (base) Peak
  - 32 (O<sub>2</sub>) — 10–40% of N<sub>2</sub>
  - 40 (Argon) — <10% of N<sub>2</sub>

**Note** Several factors strongly influence the ion ratios listed above: tune file, gas flow, gas quality, temperature, and time from pump down.

- Using hydrogen as a carrier gas changes the air/water spectrum on the TSQ 9610 system. It general more background peaks due to the increased reactivity of the hydrogen gas with the components inside of the sample path. See [Figure 213](#) for an image of a typical TSQ 9610 air/water spectrum when hydrogen is used as a carrier gas.

**Figure 213.** Typical TSQ 9610 Air/Water Spectrum for a System with Hydrogen Carrier Gas



The following conditions can cause changes in the air/water spectrum on the TSQ 9610 instrument.

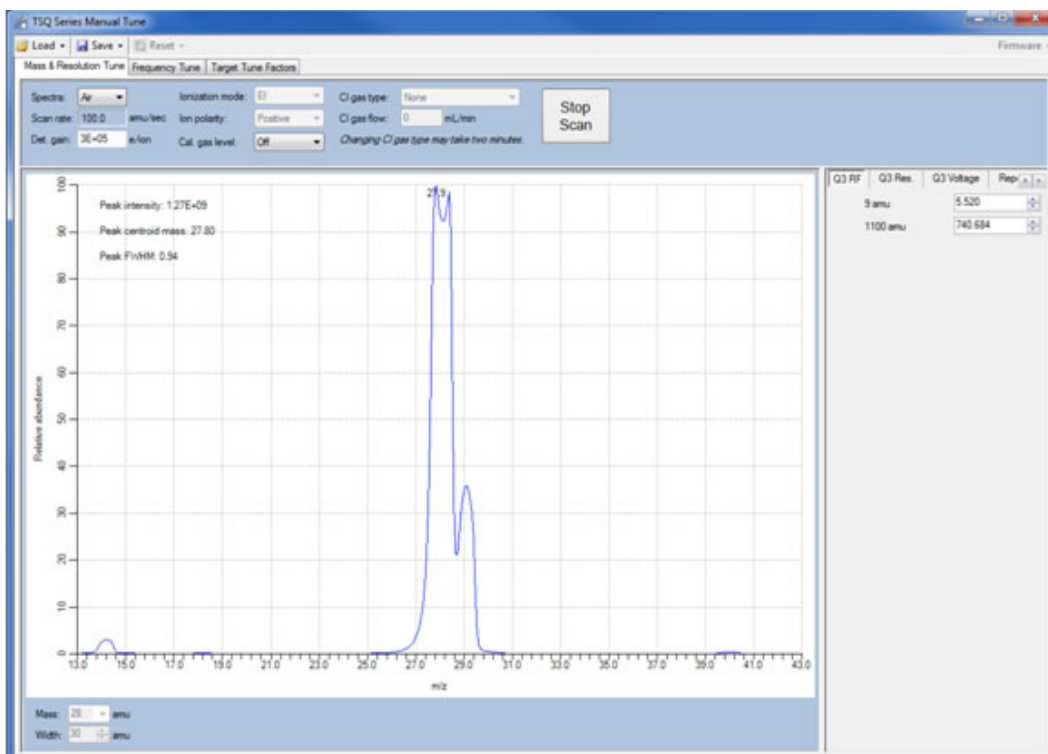
- Standard detector gain is equal to  $3 \times 10^5$ , but this can vary depending on customer defined tunes.
- As the instrument pumps down over time, the ratio of 18/28 will change as  $m/z$  18 decreases with  $m/z$  28 remaining constant. This eventually changes  $m/z$  28 to the base peak.
- Changing components of the system such as the column, ion source, or gas supply affects the different masses present in the air/water spectra.
- Maximum intensity may vary based on different instrument parameters, such as changing the column flow, or accessories.

If any of the previous conditions are not met and a leak is suspected as the root cause, follow “An air leak has been detected” in the “*Investigating Vacuum Issues*” section of the **TSQ 9610 Hardware Manual** or “How to Know When Your System Needs Maintenance” on page 226.

The next several images show a typical air/water spectrum for several common problems.

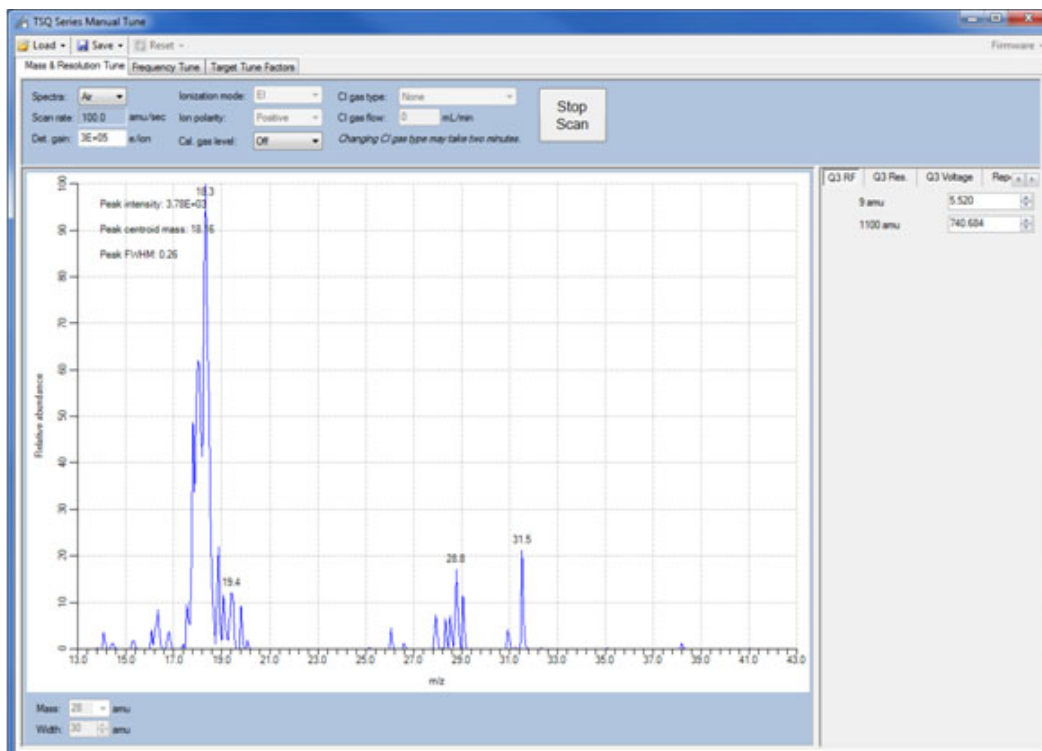
1. Figure 214 is an example of an air/water spectrum of a system with a potential air leak.

**Figure 214.** Typical Air/Water Spectrum of a TSQ 9610 System with an Air Leak



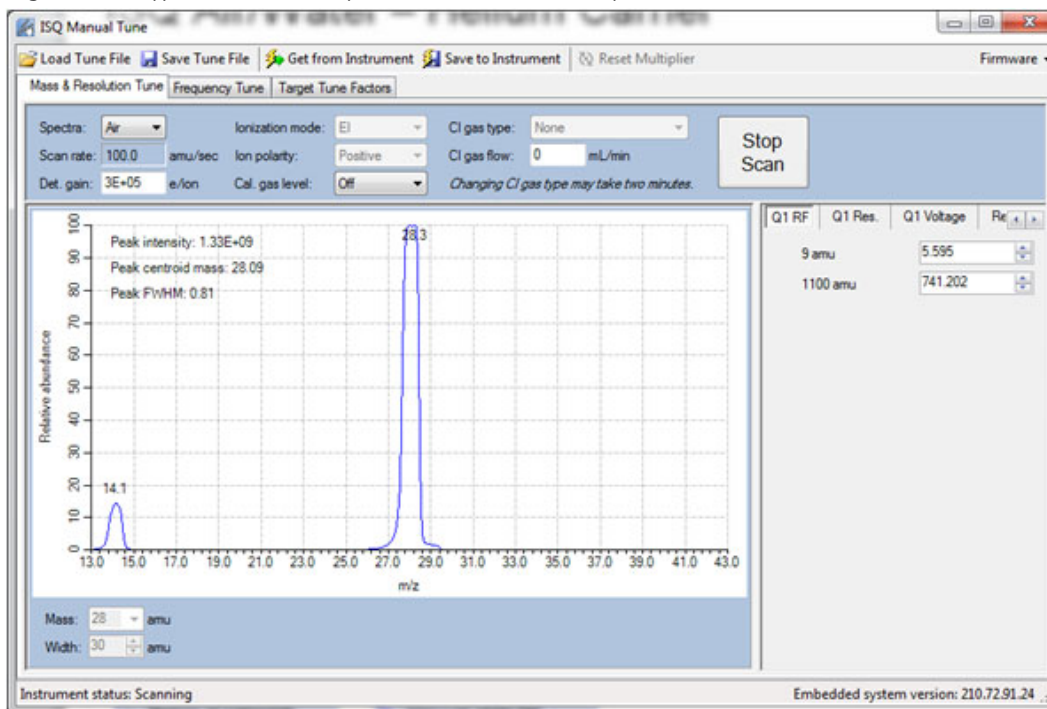
2. Figure 215 is an example of a system with an incorrectly installed ion source.

**Figure 215.** Typical Air/Water Spectrum of a TSQ 9610 System with an Incorrectly Installed Ion Source Cartridge



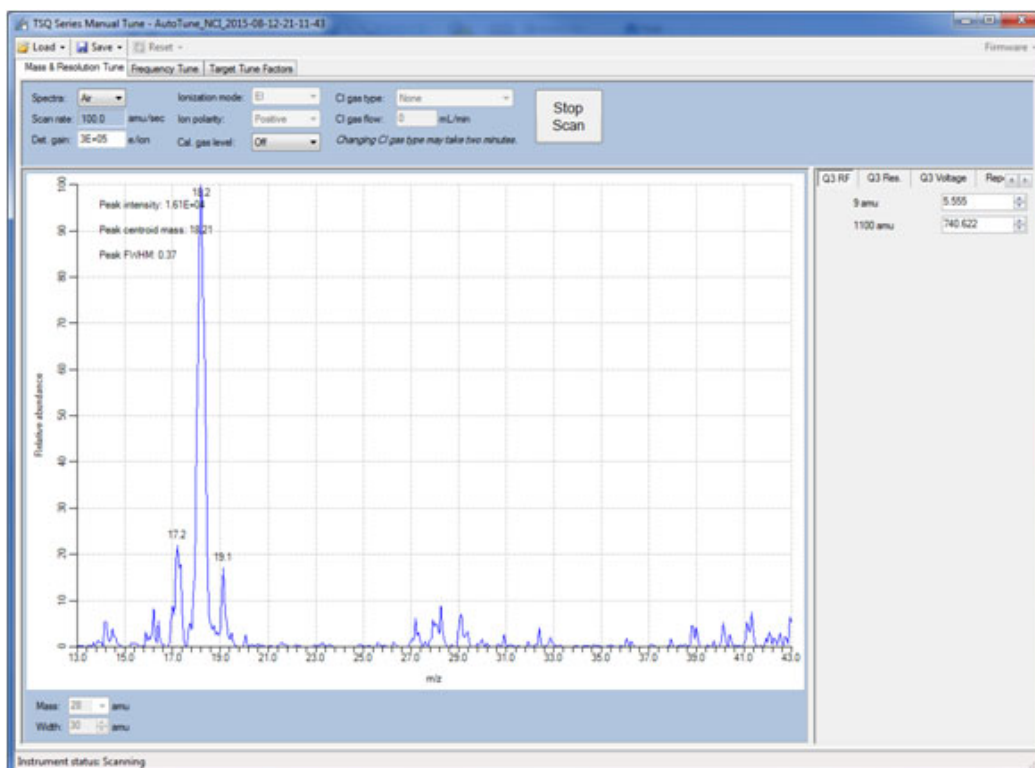
3. Figure 216 is an example of a system with no column flow.

**Figure 216.** Typical Air/Water Spectrum of a TSQ 9610 System with No Column Flow



4. Figure 217 is an example of a spectrum with a CI tune file run with an EI ion source.

**Figure 217.** Typical Air/Water Spectrum of a TSQ 9610 System with an EI Ion Source Run with a CI Tune File



## Diagnostics Checks

The following table provides you with possible corrective actions you can take after failing a diagnostics check on your system.

**Note** If you are unsure about what to do if your system fails a diagnostic, please contact your field service engineer.

**Table 2.** Diagnostics and Corrective Actions

Diagnostic	Cause of Failure	Corrective Action
Communication Check	Unknown	Contact your Field Service Engineer.
Frequency Check	RF Dip is not correct	Run a full tune that will correct for any RF dip problems. Ensure source cartridge is installed. Contact your Field Service Engineer.
SRM Efficiency Check	Collision gas is not supplied correctly Q1 is poorly tuned	Check collision gas tank and pressure. Run an EI Full tune (not a quick tune).
Lens Continuity Check	Ion source not inserted properly Lens plate and/or springs are damaged A wire is disconnected or shorted inside the manifold	Remove and reinsert ion source. Contact your Field Service Engineer. Contact your Field Service Engineer.

## Resetting Chromeleon after Replacing a Blown Filament

If you have replaced a blown filament on your instrument, you must reset the filament parameter in Chromeleon software. See the *ISQ and TSQ Series Spare Parts Guide* for information about ordering a new filament and the *TSQ 9610 Hardware Manual* for instructions on replacing a filament.

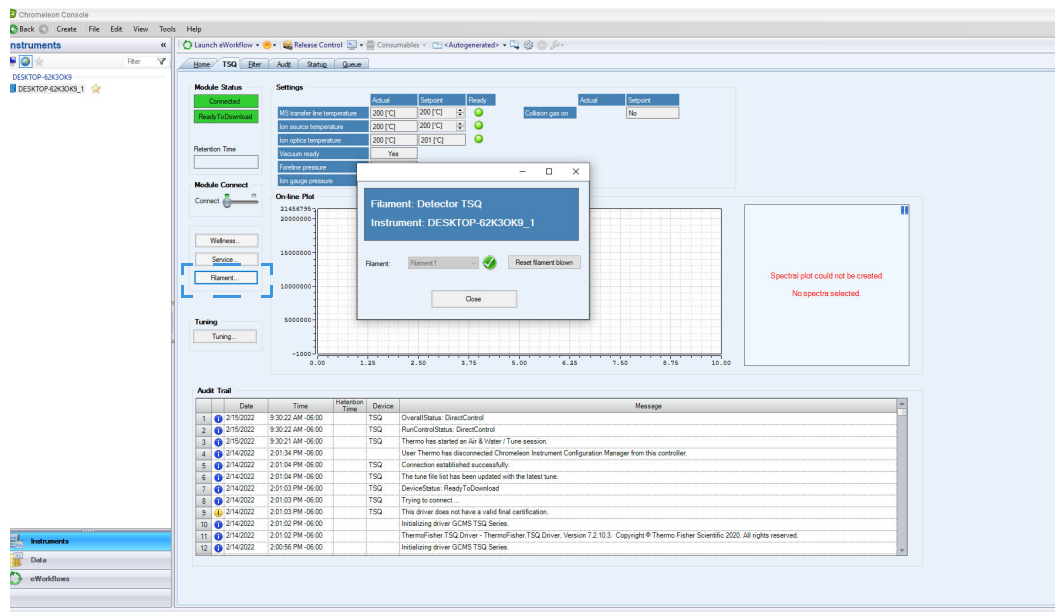
### ❖ To reset the filament parameter in Chromeleon software

1. Click **Filament** on the TSQ tab in the Chromeleon Console. The Filament window opens.
2. Click **Reset Filament Blown**. See [Figure 218](#).

## 8 Troubleshooting

How to Know When Your System Needs Maintenance

**Figure 218.** Resetting the Filament Parameter in Chromeleon Software

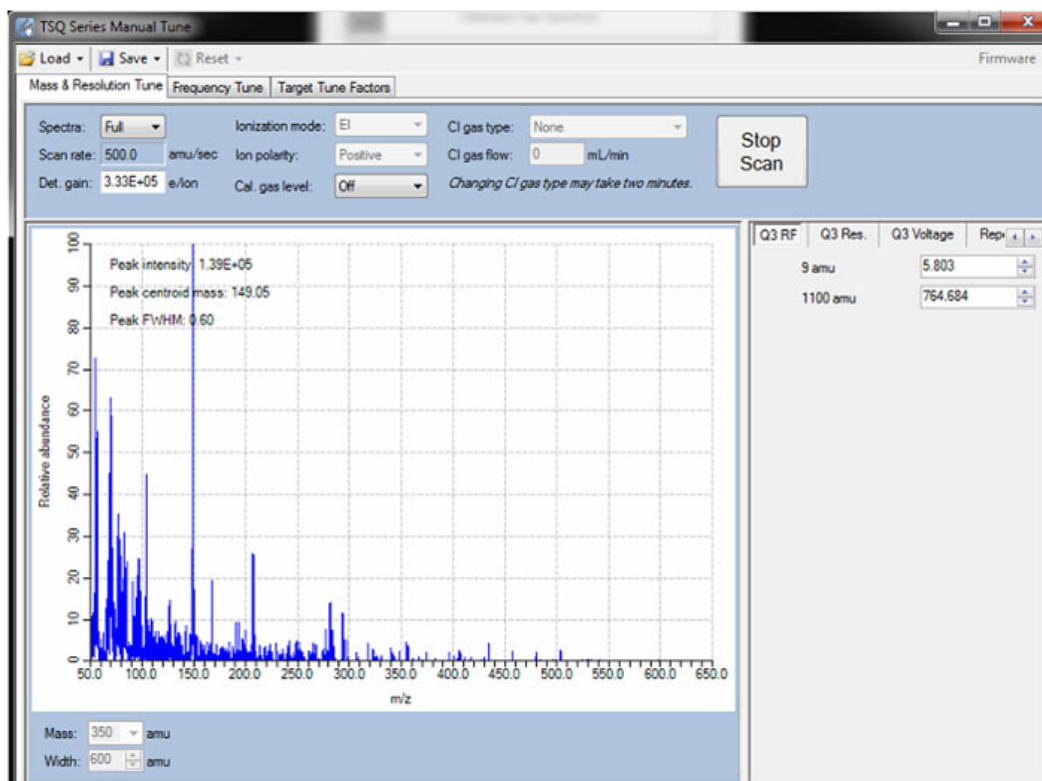


3. Click **Close**.

## How to Know When Your System Needs Maintenance

Typically, you will notice that your instrument needs maintenance when you are analyzing your data on the computer. [Figure 219](#) shows a normal full scan background on a TSQ 9610 system.



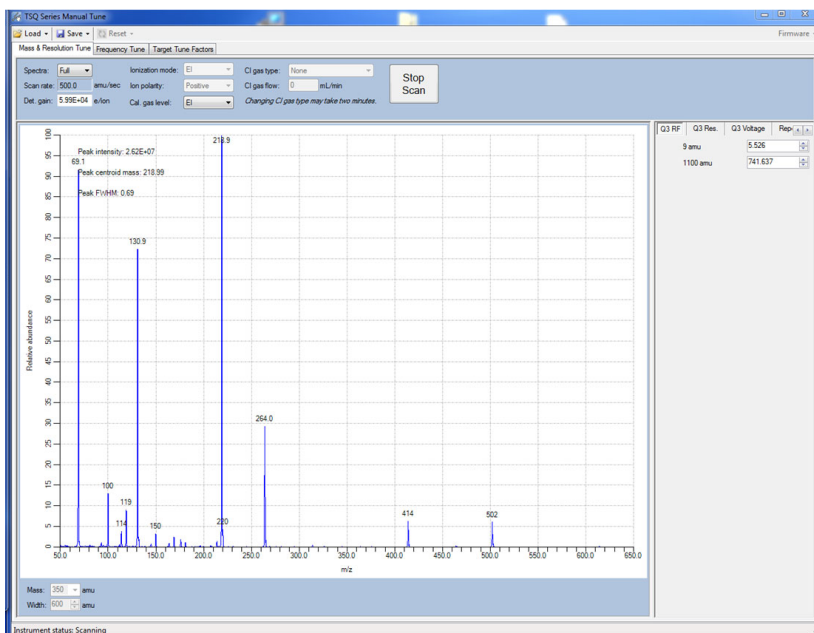
**Figure 219.** Typical Full Scan Background Spectrum of a TSQ 9610 System

A typical system meets the following conditions;

- Detector gain —  $3 \times 10^5$
- Maximum intensity —  $< 1 \times 10^6$
- There should be exponential decay for background noise.
- There should be no extraneous peaks indicating contamination.

If you run a sample with perfluorotributylamine (PFTBA), the tuning compound, the spectrum should look similar to [Figure 220](#) below.

**Figure 220.** Typical Cal Gas Full Scan Profile Spectrum



A typical PFTBA profile spectrum meets the conditions below with a clean EI ion source.

- All status indicators on the TSQ Series Dashboard are green.
- Turbo Pump  $\geq 95\%$
- Typical intensity  $>8 \times 10^6$  (8,000,000)

**Note** The intensity changes with detector gain and SmartTune adjusts gain to adjust intensity. To determine if the intensity is acceptable, compare the intensity to archived tune reports for the instrument when the ion source was clean.

**Note** The intensity is higher if an AEI ion source is in use on the system.

**Note** Relative ion abundances change with ion source temperature. Increasing the ion source temperature reduces the relative abundance of higher mass ions. The spectrum above was acquired with the ion source at 200 °C and with 1.2 mL/min Helium carrier gas.

- The ions  $m/z$  69, 131, 219, 414, and 502 are all present and in the correct relative ratios.
  - $m/z$  69 or  $m/z$  219 is the base peak
  - $m/z$  131 and  $m/z$  219 between 30-100%
  - $m/z$  414 and  $m/z$  502 between 1-10%
  - $m/z$  100, 119, and 264 are also present and cleanly separated from any noise.
- Mass assignments are correct. Review the tune report for true mass assignment values.

- No extraneous peaks indicating contamination are present.

Some of the most common reasons and indications that your system needs maintenance are as follows:

- **Contamination**—Excessive background in your mass spectra usually indicates that your instrument is contaminated. Use the mass spectrum in the table below to understand the origin of the contamination. Cleaning solvent peaks usually indicate that the ion source cartridge was installed before it completely dried.
- **Fingerprints**—A series of mass peaks in your data that are 14 amu apart usually indicates fingerprint or other hydrocarbon contamination. To avoid fingerprints, wear clean, lint-free gloves when performing any type of maintenance on a component in the vacuum manifold of the instrument.
- **Air Leaks**—Higher than normal vacuum pressure or poor sensitivity usually indicates an air leak. Check the last o-ring or ferrule that you installed.

**Table 3.** Common Contaminants

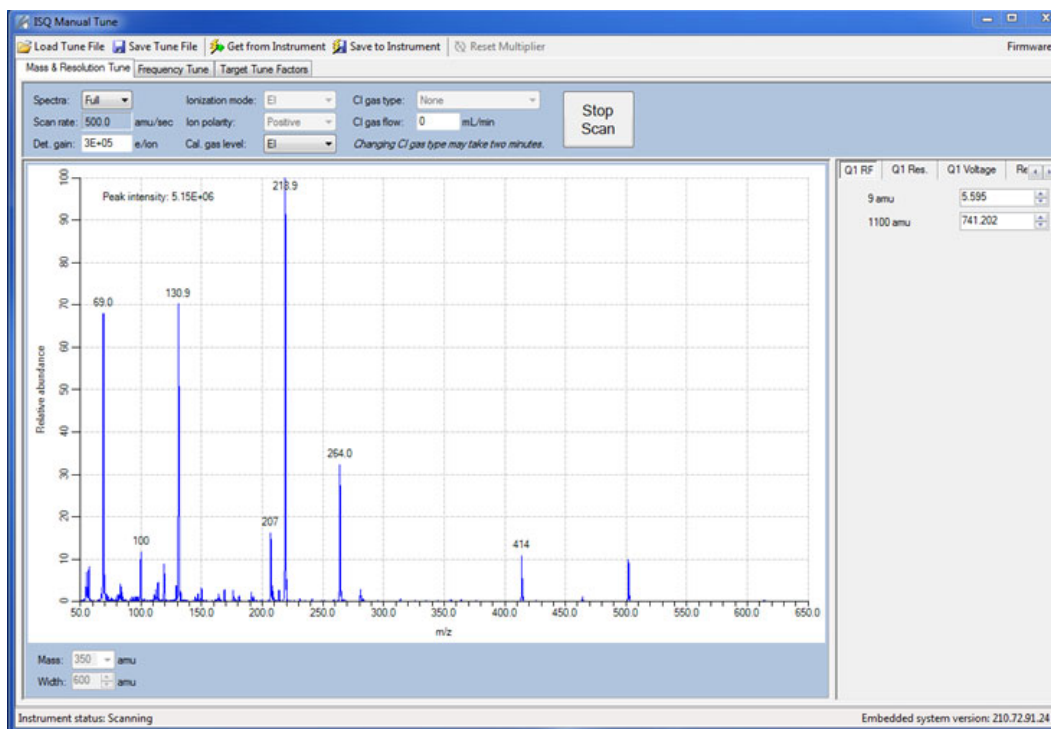
Ions ( <i>m/z</i> ) To Monitor	Compound	Possible Source
13, 14, 15, 16, 17, 29, 41, 57	Methane	CI gas
18, 28, 32, 44 or 14, 16, 19	H <sub>2</sub> O, N <sub>2</sub> , O <sub>2</sub> , CO <sub>2</sub> or N, O	Residual air and water, air leaks, outgassing from Vespel ferrules
69, 100, 119, 131, 169, 181, 214, 219, 264, 376, 414, 426, 464, 502, 576, 614	PFTBA and related ions	PFTBA (tuning compound)
31	Methanol	Cleaning solvent
43, 58	Acetone	Cleaning solvent
78	Benzene	Cleaning solvent
91, 92	Toluene or xylene	Cleaning solvent
105, 106	Xylene	Cleaning solvent
151, 153	Trichloroethane	Cleaning solvent
149	Plasticizer (phthalates)	Use of vinyl or plastic gloves
Peaks spaced 14 amu apart	Hydrocarbons	Fingerprints, foreline pump oil, or other hydrocarbons

Figure 221 shows an abnormal PFTBA profile spectrum.

## 8 Troubleshooting

How to Know When Your System Needs Maintenance

**Figure 221.** Abnormal PFTBA Spectrum



In [Figure 221](#), the abnormal results are as follows:

- Maximum intensity  $< 1.5 \times 10^7$  (15,000,0000).
- $m/z$  207 is prominent, indicating column bleed.
- Many small contamination peaks present.

**Note** These are the expected conditions if the calibration gas vial needs to be recharged. If all these conditions are met, please recharge the calibration gas vial before proceeding with troubleshooting.

## Investigating Baseline Issues

Behavior	Characteristic	Cause	Remedy
Drifting Baseline	General	Stationary phase has accumulated in column	Replace the column or cut off the end of the column.
		Chromatographic baseline is high	Replace the column or cut off the end of the column.
		Carrier gas pressure is too low	Check for leaks in injector or flow path. Replace the carrier gas cylinder if it is empty or low. Increase the pressure if maximum injector pressure in method is greater than carrier line pressure set by regulator. Make sure the vacuum compensation is on.
		Carrier gas flow is drifting	Check for leaks in injector or flow path. Check the carrier gas tank.
		Impurities have accumulated in column	Run solvent blank to remove impurities. If impurities persistent after multiple solvent blanks: Inject solvent from a different source. Change syringe, liner and septum. Clean injector. Check impurity levels in your gas. Use the correct gas purity and filter.
Falling		Carrier gas leak in the system	Perform a leak test and tighten the connections to the carrier gas line if leak is found.
		Column is baking out	Wait for the column to stabilize.
Rising		Impurities have accumulated in column	Check impurity levels in the gas source. Use correct gas purity.
Abnormal rise in baseline when oven temperature is high		Impurities have accumulated in column	Recondition or replace the column.

## 8 Troubleshooting

### Investigating Baseline Issues

Behavior	Characteristic	Cause	Remedy
Noisy Chromatographic Peaks	General	Excessive column bleed at high oven temperatures	Reduce the column temperature. Bake out the column. Install a high-temperature column.
			Install oxygen filters in carrier gas line. Check pneumatic and inlet systems for leaks. Use correct gas purity with low oxygen content.
		Column is contaminated or damaged	Condition or replace the column.
		Oven temperature is higher than column's maximum allowable temperature	Reduce oven temperature to the maximum allowable temperature of the column.
		Leak at column fittings	Find leak. Tighten fittings if loose. Replace ferrule if overtightened.
			Transfer line temperature is not set too low.

## Investigating Peak Issues

**Table 4.** Troubleshooting Peak Issues in Your Data (Sheet 1 of 3)

Behavior	Characteristic	Cause	Remedy
Broadening	General	Column flow higher than optimum of column	Reduce the flow. Make sure vacuum compensation is turned on.
		Column flow lower than optimum of column	Increase the flow.
		Split flow is too low for split injection	Increase the flow to 40-50 ml/min.
		Performance of the column has degraded	Test the column at the optimum flow rate.
		Injector is dirty	Clean or replace the liner.
		Ion source is dirty	Clean the ion source and tune the instrument.
		Column is not far enough into the transferline	The GC column does not extend into the MS source. Use the column measuring tool to confirm column length. If the end of the column is inside the transfer line, an excessive amount of GC effluent will contact the inside wall.
Fronting	General	Column is overloaded	Decrease the injected amount and/or analyte concentrations. Increase the split ratio. Use a column with a thicker film.

**Table 4.** Troubleshooting Peak Issues in Your Data, continued (Sheet 2 of 3)

Behavior	Characteristic	Cause	Remedy
Tailing	Sample peaks	Column degradation is causing activity	Inject a test mixture and evaluate the column. Replace column if necessary.
		Liner is dirty	Clean or replace the liner.
		Ion source is dirty	Clean the ion source and tune the instrument.
		Glass wool or inlet liner is causing activity	Replace wool with fresh silanized wool and install a clean inlet liner.
		Inlet temperature is too low	Increase the temperature of the inlet.
		Column connections are poor or obstructed	Reconnect the column inlet.
		Stationary phase is not appropriate for your target compounds	Replace the column and choose a more appropriate phase for your analysis.
		Final hold oven temperature is too low	Increase the column/oven temperature. Do not exceed the recommended maximum temperature for the stationary phase.
		Transferline temperature is too low	If tailing occurs on late eluting compounds, it is likely the source or transferline temperature is too low.
		Source temperature is too low	If tailing occurs on late eluting compounds, it is likely the source or transferline temperature is too low.
Poor column characterization	See <a href="#">Changing the Column</a> for information about checking for leaks and column flow.		



**Table 4.** Troubleshooting Peak Issues in Your Data, continued (Sheet 3 of 3)

Behavior	Characteristic	Cause	Remedy
Ghost Peaks	General	Incomplete elution of previous sample	Increase the final oven program temperature or total run time. Increase the column flow rate.
		Carrier gas is contaminated	Replace the gas cylinder or filter.
		Laboratory glassware has caused contamination	Ensure the glassware is clean and contaminant-free.
		Injected sample has decomposed	Decrease the injection port temperature. Use the on-column injection technique.
		Injection solution has matrix present	Adequately clean up your sample prior to injection.
Missing Peaks	Baseline or background present	Column is broken	Replace the column.
		Column flow is incorrect	Make sure the septa are sealing. Make sure vacuum compensation is turned on.
		Backflush settings are incorrect	Set backflush to <b>off</b> until after injection.
		Column position in S/SL injector is incorrect (too high)	Check the position of the column.
	No baseline or background present	Poor or missing electrical connection	Check the cable connections.
		Mass spectrometer is not collecting data	Make sure the tune file is correct. Verify that the Busy light is on during acquisition. Make sure the filament is not burned out. Close <i>Xcalibur</i> , open <i>Instrument Configuration</i> , press the <b>Reset</b> button on the mass spectrometer, wait ten seconds, close <i>Instrument Configuration</i> .

## Investigating Results Issues

Behavior	Characteristic	Cause	Remedy
Low Reproducibility of Peaks Area	General	Detector gain is set too low	Retune the gain. Increase the electron multiplier voltage. Increase the target ion count.
		Concentration is not compatible with the dynamic range of the detection system	Verify that the sample concentration is suitable for the system.
		Chromatogram and spectrum are blank	Make sure the tune file is correct. Verify that the Busy light is on during acquisition. Make sure the filament is not burned out.
		Injection technique is not appropriate	Use a different injection technique.
		Injection parameters are not appropriate	Verify the injection temperature and flow rates.
		Sample injection technique is not reproducible	Evaluate the sample preparation sequences. Compare the results with a series of standard injections.
		Syringe or septum is leaking	Check and replace the syringe and/or septum at regular intervals.
		Injection port is leaking	Check the column connections. Run a leak check.
		Injection technique is not suitable	Carefully meter the injected amount. Use a clean, good-quality syringe.
		Ion source is dirty	Clean the ion source and retune the instrument.
Split flow or ratio control is inadequate	Monitor the flow. Replace the in-line filter.		

Behavior	Characteristic	Cause	Remedy
Poor Sensitivity	With increased retention time	Carrier gas flow rate is too low	Increase the carrier gas flow rate. Locate and remove possible obstructions in the carrier gas line. Check the septum for leaks. Check the injector/column ferrules for leaks.
	With normal retention time	GC carrier gas line has leaks	Run a leak test and correct leaks.
		Syringe is leaking during injection	Replace syringe or piston seals, if necessary.
		Split injection temperature is too low	Increase the temperature of the injector.
Retention Times	Low reproducibility	Voltage is not reaching the lens.	Replace the lens plate and springs if damaged. Remove debris or broken pieces in the manifold. Run a lens check diagnostic. Check the connection by removing or inserting the ion source.
		DCC is drifting or unstable	Monitor the column pressure or flow. Check and replace the controller, if necessary.
		Injection technique is inadequate	Pick injection technique suitable for the injector and liner you are using.
		Vaporization size of sample inject larger than volume of liner	Reduce the injected amount and/or volume.
		Column temperature is unstable	Check the main oven door and cooling flap. Monitor the column temperature.





# Index

## A

acquisition methods, purpose of, [76, 120](#)  
AEI Tunes [56](#)  
AutoTune, modifying, [153](#)  
AutoTune, using, [47](#)  
Autotune, using, [46](#)

## B

baseline (troubleshooting)  
  drifting, [231](#)  
baseline issues, investigating, [231](#)

## C

centroided data, about, [84, 125](#)  
chromatographic separation, changing, [145](#)  
column  
  changing, [21](#)  
  leak checking, [40](#)  
  temperature, [42](#)  
compliance  
  FCC [viii](#)  
  regulatory [vii](#)  
  WEEE [x](#)  
Configuring the TSQ 9610, [6](#)  
contaminants, common, [229](#)  
contamination, indications, [229](#)

## D

data result issues, investigating, [236](#)  
diagnostics, selecting tests to run, [160, 177](#)

## E

EMC compliance [vii](#)

## F

FCC compliance [viii](#)  
filament voltage, setting, [156, 174](#)  
filament, turning off and on, [86, 127](#)  
fingerprint, indications, [229](#)  
full-scan mode, about, [83, 125](#)

## G

GC  
  creating a method, [104, 116](#)  
ghost peaks, troubleshooting, [235](#)

## I

iConnect High Temperature Transfer Line Nut [24](#)  
ion source temperature, setting, [79, 121, 157, 175](#)

## L

leak, indications, [229](#)  
leaks, checking for, [40](#)

## M

maintenance, settings, [14–15](#)  
mass range, narrowing, [147](#)  
methods  
  acquisition, [76, 120](#)  
  creating, [69](#)  
  purpose of, [69](#)

## P

peak height, minimum, [79, 122](#)  
peak issues, investigating, [233](#)  
peaks (troubleshooting)  
  broadening, [233](#)  
  fronting, [233](#)  
  ghost, [235](#)

## Index: R

none, 235  
tailing, 234  
profiled data, about, 84, 125

## R

regulatory compliance vii  
results (troubleshooting)  
    low reproducibility of peaks area, 236  
    poor sensitivity, 237  
    retention times, 237  
retention times, troubleshooting, 237  
routine maintenance  
    causes, 226

## S

safety standards vii  
scan rate, optimizing, 146  
scans, running, 80, 122  
sensitivity, troubleshooting, 237  
source plug 34

## T

tailing peaks, troubleshooting, 234  
temperature of the ion source, 79, 121  
temperature of the transfer line, 147  
temperature of transfer line, 78, 121  
transfer line temperature, setting, 78, 121  
transfer line, about, 78, 121  
troubleshooting  
    about, 217  
    baseline issues, 231  
    peak issues, 233  
    results issues, 236  
    tune report, 61  
TSQ 9610  
    changing the column, 21  
    configuring, 6  
    creating a method, 69  
TSQ 9610 AutoTune, about, 153  
tune reports  
    example report, 61  
    printing, 61  
    settings, 61  
tune types  
    adding, 56  
    AEI tunes, 56  
    CI- tune, 53  
    daily tune check, 50  
    daily tune, 46  
    EI full tune, 50

tuning  
    using Autotune, 46–47  
    with Autotune, 46  
    with ISQ 7000 AutoTune, 47

## U

using, 34

## V

V-lock source plug 34  
voltage of filament, setting, 156, 174

## W

WEEE compliance x